



MIXING CONSOLE

MGP Series

MGP32X MGP24X MGP16X MGP12X





Digital Heart. Analog Soul.

Yamaha has provided an impressive range of lineups in professional audio since the release of the PM200 in 1972—our first ever professional analog mixing console. In 1987, we also released our first digital mixer, the DMP7, and have subsequently advanced technological innovations in sound quality, reliability and advanced functionalities with cutting-edge digital technologies.

Drawing from our decades of experience crafting innovative, premium analog gear, we originally developed our new discrete Class-A microphone preamps for professional use in our high-end recording equipment. Utilizing an inverted Darlington circuit design, our newly-refined D-PRE mic preamps deliver a fat, rich, smooth tone that gives the MGP Series a significant advantage over any other mixer in its class.



With Yamaha's proprietary X-pressive EQ we've managed to capture ultimate analog authenticity by unlocking the mysterious secrets behind the expressive sound shaping capabilities of sought-after classic EQ modules.

At the heart of the MGP's compact configuration, we've taken an innovative new approach to the utilization of digital technology in an analog mixer; adding high-resolution effects, iPod/iPhone integration and the superb functionality of our new Stereo Hybrid Channel to the warmth and musicality of premium analog sound. The MGP Series represents the ultimate balance of the converging technologies that are the heart and soul of Yamaha's extraordinary achievements in professional audio.

MIXING CONSOLE

MGP Series

MGP32X MGP24X MGP16X MGP12X

In addition to the complete redesign of the internal circuitry—from the mic preamps to the power supply—we also took a new, more intuitive approach to the knob design and control surface of the MGP Series consoles. The new color coordinated design is not only attractive and professional, but also help visually guide the operator's hands to the intended functions.



Fill Your Space with Premium Sound

Not just for live bands and DJ's, the MG Series mixing consoles can easily adapt to a truly impressive range of applications from portable PA to fixed installation. Now with the newly added digital functions and superior sound of the MGP, the possibilities are endless.







The Evolution of Analog

When it comes to audio engineering and sound reinforcement, the verdict is in—nothing beats the warmth and musicality of analog sound. By incorporating state-of-the-art digital technologies into the development process of our premium professional analog equipment, the MGP is the next step in the evolution of compact professional mixers.

D-PRE *D-PRE. Defies. Description.*



The preamp is where sound creation begins, and ultimately determines the character and quality of your overall mix. The importance of this critical first step inspired us to develop the most fat and warm sounding preamps possible—our newly refined D-PRE mic preamps. Initially intended for use with Yamaha's high-end recording gear, these studio-grade, discrete Class-A mic preamps employ an inverted Darlington circuit design that features multiple circuitry elements in a multi-layered configuration in order to deliver more power with lower impedance. This means all the character, depth and feel of your original signal will be delivered with fat, natural sounding bass and smooth, soaring highs. Rediscover a favourite mic or trusted instrument by capturing the full range of your musical expression with sound that you don't hear, so much as feel. With 48V phantom power for each channel and a sound that is incomparable in a compact mixer today, these studio-grade discrete Class-A mic preamps set the MGP apart, clearly defining a class all its own.

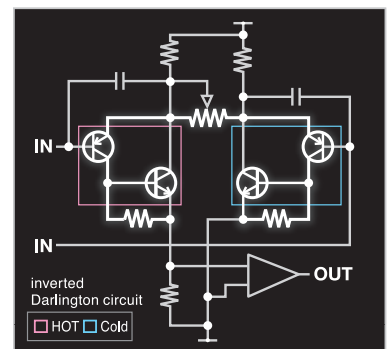

1-Knob Compressors



Originally a Yamaha innovation, 1-knob compression is now a popular feature on an increasing number of compact mixing consoles with good reason. These intelligent compressors add optimally set compression to a wide variety of input sources with the touch of a single control—minus the hassle of setting up and configuring complex outboard gear. The MGP features our newly upgraded

1-knob compressors that feature LED indicators allowing you to visually monitor when the compression “kicks in” on each channel.





X-pressive EQ X Marks the Spot



Everyone knows vintage EQ sounds great—but not everyone knows why. Throughout the development of the innovative VCM (Virtual Circuit Modeling) effects used in our high-end professional digital mixers, we became increasingly focused on reproducing the warmth and musicality of classic vintage EQs. It was through our precise modeling of the original circuitry of some of the most sought-after EQ modules from the past that we discovered a characteristic “X-shape” of the frequency curves that was unique to these units—and would ultimately prove essential to unlocking real vintage authenticity. More than just a means of tweaking your mix, the precise response and very steep shelving of the high and low frequencies make the X-pressive EQ a powerful sound-shaping tool that essentially redefines the role that EQ plays in sound reinforcement. Never before has an audio engineer’s contribution to the overall sound been so significant, with X-pressive EQ providing complete control of every aspect of your sonic palette.

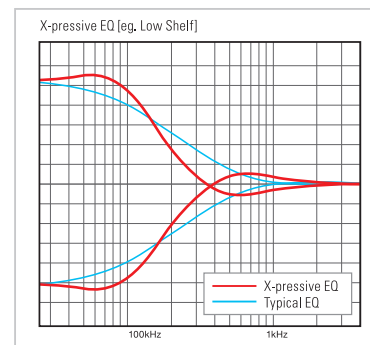

Internal Universal Power Supply



You can plug in with confidence in any region with 100V- 240V power thanks to our highly-efficient internal universal power supply. With its multi-voltage design, the MGP ensures worry-free operation in potentially damaging environments with fluctuating power levels. An internal power supply also simplifies rack mounting of the console at installed applications, with no use for a bulky adapter or additional connections.



A Revolution in Digital

The MGP is the realization of a new approach towards the utilization of digital technologies in a mixer, offering simple, analog-style control of sophisticated DSP functions.

One of the most compelling features of analog gear is the direct, hands-on, intuitive operation that unites the operator with the console. The MGP design sought to keep this feel consistent throughout the design to offer a wealth of functionality, yet with a simple, familiar touch.

More Than Just Digital... it's Hybrid.

Hybrid Channel



40 years of experience working with professional mixers has led Yamaha to offer a new way of approaching sound reinforcement in the digital age: the Stereo Hybrid Channel. Beneath the analog-style knobs and encoders of MGP Series mixing consoles lies a sophisticated digital control system—a fusion that combines traditional analog feel with the functionality that only digital technology can offer. The MGP Series utilizes a powerful, proprietary DSP to provide three essential features that are staples of both installed and live sound applications. In keeping with the theme of analog simplicity found throughout the MGP Series design, each of these functions is readily accessible and available at the touch of a button. Featuring a mid-sweep, three-band EQ for nuanced sound control and high-performance onboard A/D and D/A converters, the Stereo Hybrid Channel offers unique functionality with superior sound.



Priority Ducker



An invaluable feature for applications that require both public-speaking and background music, Priority Ducker allows a microphone to take priority over another sound source automatically, just by speaking into the mic. Stop talking and the other sound source is brought back to its original level, therefore no console operator is required for this simple yet valuable function. You can even adjust the ducker attenuation of sound source depending on your preferences.



Leveler



This intelligent compressor "auto levels" different tracks from a sound source that vary in volume, providing a more pleasurable listening experience. Ideal for small events with un-manned operation of your console, Yamaha's proprietary DSP algorithm allows for extended play time without the worry of fluctuating volume levels distracting your listeners.



Stereo Image



The Stereo Image function seamlessly narrows the pan balance of the stereo sound source so that audiences spread over a wide area can enjoy a comfortably blended mix. This is particularly helpful for installed sound applications that requires background music. Using either of the two optimized settings—MONO and BLEND—Stereo Image ensures that everyone is in the "sweet spot" by providing a more optimally mixed sound to the entire space.

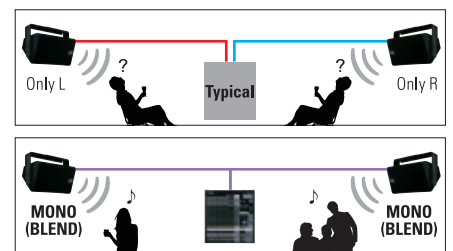

Advanced REV-X and Classic SPX

Dual Digital Effects



MGP Series mixing consoles offer two separate studio-grade effects processors for ultimate enhancement of your sound, with simple intuitive control. Yamaha's high-end REV-X reverb offers three very musical and natural high-resolution reverb effects: Hall, Room and Plate—a first for any Yamaha analog mixer. For more sound-shaping possibilities, Yamaha's renowned SPX digital multi-effect processor provides a useful selection of 16 advanced digital effects with editable parameters. Both processors can be used simultaneously, giving you a vast array of tools to color your sound.

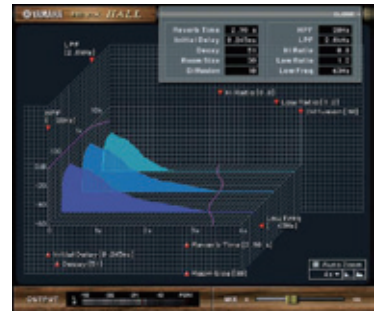

Integrate Your Apple Devices into Your MGP Sound Experience

Digital Connectivity for Your iPod/iPhone

In response to the growing demand for compatibility with iPod/iPhone, iPod/iPhone integration with the MGP offers much more than simple playback. With a single connection your Apple device is transformed into a flexible controller, giving you more detailed control of your MGP console.



*Appearance may differ in final version

MGP Editor

 MGP Editor is a free software application that gives you additional control of your console's DSP settings via your iPod/iPhone. With a simple and intuitive graphic display, MGP Editor gives you additional, detailed control of your REV-X and SPX effects parameters—as well as Hybrid Channel's Priority Ducker, Leveler and iPod/iPhone's playback settings. With MGP32X and 24X, setting of GEO and Master comp can be adjusted. Direct playback of iTunes play list is also possible.



* MGP Editor can be downloaded from Apple's App Store at no charge.
* Apple, iPhone and iPod are trademarks of Apple Inc., registered in the U.S. and other countries. App Store is a service mark of Apple Inc.



High-Quality Digital Playback

The MGP Series mixers feature a built-in USB port to connect and charge your iPod or iPhone for seamless playback with a single connection. A direct digital connection offers a much higher level of quality with more detail and clarity than typical analog inputs can provide.





Attractive New Digital Features for MGP32X and MGP24X

USB Device Recording and PlayBack



It's easy to archive every performance when recording is this easy. The record function allows direct recording to a conventional USB storage device. Choose from Stereo Out or Matrix Out 1 and 2 as the source, and select WAV or MP3 as file formats. Playback of audio files is also supported with the USB device. You can easily route this to a hybrid channel or to monitor out.





Graphic EQ

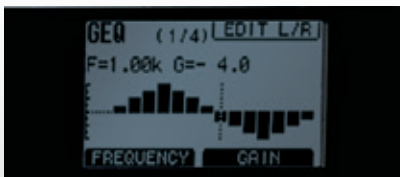

The new Graphic EQ feature 14 band and flex 9 band modes that can easily be controlled via internal display. This Flex EQ is also used in

Yamaha's pro-level CL series consoles. By limiting the number of bands for boost and cut, the extra DSP can be employed to narrow the filters to 1/3 octave, and allow the user to sweep the filter to the range where adjustment is required. With 31 different filter positions, very fine adjustments can be made. Additionally, finding and reducing feedback is quick and easy using the offset/gain controls to point out vulnerable frequencies before the feedback occurs.



Multi-band Compressor

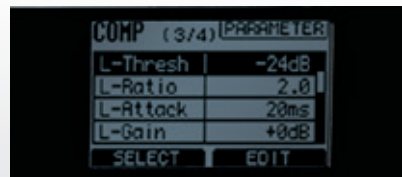

The MGP32X and MGP24X are the first mixers in this class to be equipped with a master compressor on the stereo bus.

Both a standard type (COMP) and a three-band divided (Multi-band) master compressor have been built in. Using a master compressor allows you to reduce the overall dynamic range of the signal to fit the environment, and protect the sound system from overloads. A total of 8 memory scenes (3 read only and 5 user defined) allow settings to easily be stored and recalled as needed quickly.



MIXING CONSOLE

MGP32X

32-Channel Premium Mixing Console

- 24 Mic Inputs with 48V Phantom Power and HPF per Channel
- 32 Line Inputs (24 mono and 4 stereo)
- 6 AUX Sends + 2 FX Sends
- 4 GROUP Buses + ST Bus
- 2 Matrix out
- 1 Mono out



Main Features



- Studio-grade discrete class a "D-PRE" mic preamps with an inverted darlington circuit
- Musical X-pressive EQ based on Yamaha's famed VCM technology
- Professional 1-knob compressors with LED indicators
- Internal universal power supply for world-wide use
- Stereo hybrid channels
- Digital connectivity for iPod/iPhone
- High-grade dual digital effects processors : advanced REV-X and classic SPX
- MGP Editor for detailed control of the console's DSP settings via iPod/iPhone
- Rugged, impact-resistant, powder-coated metal chassis
- Record to or playback from a connected USB device
- 31 band GEQ with selectable 9 flex-band or 14 fixed band mode.
- Three-band master compressor is assigned to stereo bus

MIXING CONSOLE

MGP24X

24-Channel Premium Mixing Console

- 16 Mic Inputs with 48V Phantom Power and HPF per Channel
- 24 Line Inputs (16 mono and 4 stereo)
- 6 AUX Sends + 2 FX Sends
- 4 GROUP Buses + ST Bus
- 2 Matrix out
- 1 Mono out



Dimensions

MGP32X

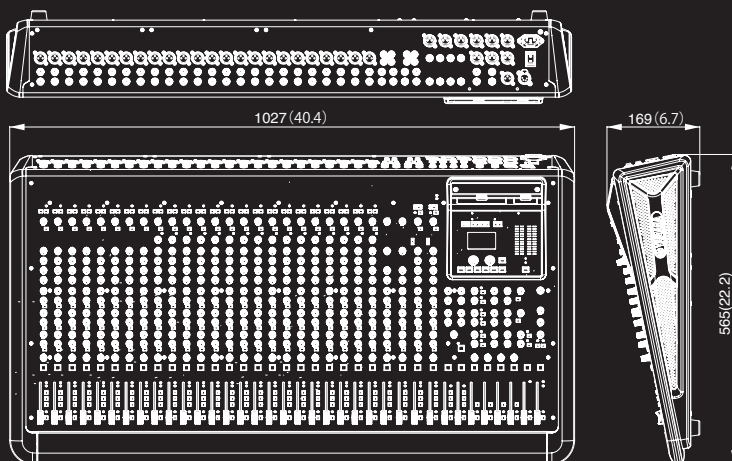

MGP24X

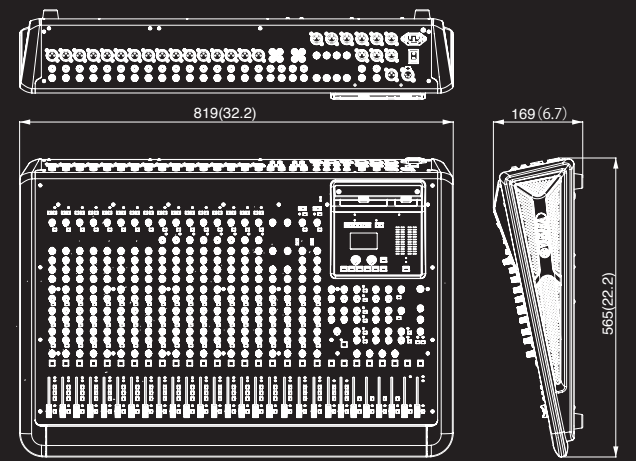

mm(inch)

MIXING CONSOLE

MGP16X

16-Channel Premium Mixing Console

- 10 Mic Inputs with 48V Phantom Power and HPF per Channel
- 16 Line Inputs (8 mono and 4 stereo)
- Additional 2TR Inputs Provided to Accept the Output from Analog Devices or iPod/iPhone
- 2 AUX Sends + 2 FX Sends
- 4 GROUP Buses + ST Bus



Main Features

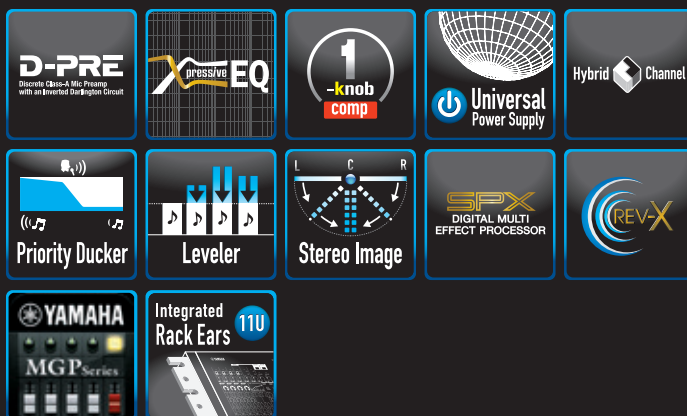

- Studio-grade discrete class a "D-PRE" mic preamps with an inverted darlington circuit
- Musical X-pressive EQ based on Yamaha's famed VCM technology
- Professional 1-knob compressors with LED indicators
- Internal universal power supply for world-wide use
- Stereo hybrid channels utilizing a powerful, proprietary DSP
- Digital connectivity for iPod/iPhone
- High-grade dual digital effects processors: advanced REV-X and classic SPX
- MGP Editor for detailed control of the console's DSP settings via iPod/iPhone
- Rugged, impact-resistant, powder-coated metal chassis
- Integrated rack-ears for easy rack mounting

MIXING CONSOLE

MGP12X

12-Channel Premium Mixing Console

- 6 Mic Inputs with 48V Phantom Power and HPF per Channel
- 12 Line Inputs (4 mono and 4 stereo)
- Additional 2TR Inputs Provided to Accept the Output from Analog Devices or iPod/iPhone
- 2 AUX Sends + 2 FX Sends
- 4 GROUP Buses + ST Bus



Integrated Rack Ears



Dimensions

MGP16X

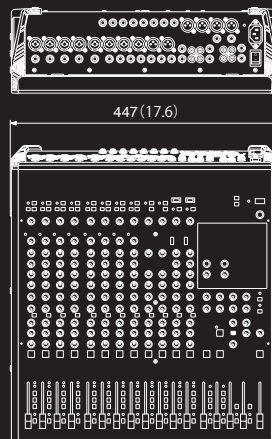

MGP12X

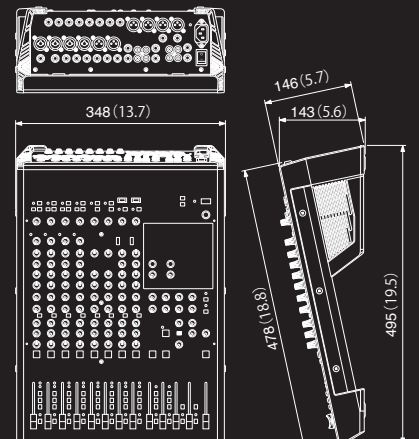

mm(inch)

MGP Series Specifications

General Specifications

	MGP32X	MGP24X	MGP16X	MGP12X
Total Harmonic Distortion 20Hz-20kHz@ +14dBu	0.02%		0.02%	
Frequency Response	+0.5/-1.0dB 20Hz - 20kHz, refer to the nominal output level @1kHz		+0.5/-1.0dB 20Hz - 20kHz, refer to the nominal output level @1kHz	
Noise	-128 dBu Equivalent Input Noise/-94 dBu Residual Output Noise 20 Hz - 20 kHz Rs = 150Ω Input Gain = Maximum		-128 dBu Equivalent Input Noise/-102 dBu Residual Output Noise 20 Hz - 20 kHz Rs = 150Ω Input Gain = Maximum	
INPUT Connectors	MIC: 24 LINE: 24 mono + 4 stereo CH INSERT IN: 24 RETURN: 1 stereo	MIC: 16 LINE: 16 mono + 4 stereo CH INSERT: 16 RETURN: 1 stereo	MIC: 10 LINE: 8 mono + 4 stereo CH INSERT: 8 RETURN: 1 stereo 2TR IN: 1 stereo	MIC: 6 LINE: 4 mono + 4 stereo CH INSERT IN: 4 RETURN: 1 stereo 2TR IN: 1 stereo
OUTPUT Connectors	STEREO OUT: 1 AUX SEND: 6 CH INSERT OUT: 24 MONITOR OUT: 1 GROUP OUT: 4 PHONES: 1 ST CH INSERT: 1 Matrix out: 2 Mono out: 1	STEREO OUT: 1 AUX SEND: 6 CH INSERT OUT: 16 MONITOR OUT: 1 GROUP OUT: 4 PHONES: 1 ST CH INSERT: 1 Matrix out: 2 Mono out: 1	STEREO OUT: 1 AUX SEND: 2 CH INSERT OUT: 8 REC OUT: 1 MONITOR OUT: 1 GROUP OUT: 4 PHONES: 1	STEREO OUT: 1 AUX SEND: 2 CH INSERT OUT: 4 REC OUT: 1 MONITOR OUT: 1 GROUP OUT: 4 PHONES: 1
Crosstalk	-74dB @ 1kHz		-74dB @ 1kHz	
Phantom Power	48V phantom power per channel		48V phantom power per channel	
Input HPF	MIC INPUT (100Hz 12dB/oct)		MIC INPUT (100Hz 12dB/oct)	
Input channel EQ	High Mid Low	8kHz: shelving 250Hz-5kHz: peaking (MGP32X: CHs 1-24, 29-32 MGP24X: CHs 1-16, 21-24) 2.5kHz: peaking (MGP32X: CHs 25-28 MGP24X: CHs 17-20) 125Hz: shelving	8kHz: shelving 250Hz-5kHz: peaking (MGP16X: CH1-8, 13-16 MGP12X: CH1-4, 9-12) 2.5kHz: peaking (MGP16X: CH9-12 MGP12X: CH5-8) 125Hz: shelving	
Compressor (COMP)	CH9-24		CH1-8	
Internal Digital Effect	control x 1 (Gain/Threshold/Ratio)		control x 1 (Gain/Threshold/Ratio)	
LED Level Meter Pre MONITOR Level	8 PROGRAM, PARAMETER control 16 PROGRAM, PARAMETER control		8 PROGRAM, PARAMETER control 16 PROGRAM, PARAMETER control	
Signal Indicator	4 x 12 segments LED meter (PEAK, +10, +6, +3, 0, -3, -6, -10, -15, -20, -25, -30dB) PEAK lights if the signal comes within 3dB of the clipping level.		2 x 12points LED meter (PEAK, +10, +6, +3, 0, -3, -6, -10, -15, -20, -25, -30dB) PEAK lights if the signal comes within 3dB of the clipping level.	
USB Audio USB IN/OUT	USB Device, iPod / iPhone		iPod, iPhone exclusive	
Power Supply	100-240V 50Hz/60Hz		100-240V 50Hz/60Hz	
Power Consumption	86W max		76W max	
Dimensions (W x H x D)	1,027x169x565mm (40.4x6.7x22.2")		819x169x565mm (32.2x6.7x22.2")	
NET Weight	19kg (41.9lb)		15.5kg (34.2lb)	

*1 Noise is measured with a A-Weighting filter. *2 Crosstalk is measured with a 1 kHz band pass filter.
*3 Maximum voltage gain is measured under the condition that all faders and GAIN knobs are at maximum. PAN/BAL knob is panned hard left or right.

*1 Noise is measured with an A-Weighting filter. *2 Crosstalk is measured with a 1 kHz band pass filter.
*3 Maximum voltage gain is measured under the condition that all faders and GAIN controls are at maximum. PAN/BAL controls are panned hard left or right.

MGP32X MGP24X

ANALOG INPUT SPECIFICATIONS								
Input terminal	PAD	GAIN	Actual source impedance	For use with nominal	Input level			Connector
					Sensitivity ¹	Nominal	Max. before clip	
MONO CH INPUT MGP32X: 1-24 MGP24X: 1-16	0	-60dB	3kΩ	50-600Ω Mics	-80 dBu (0.078 mV)	-60 dBu (0.775 mV)	-40 dBu (7.75 mV)	XLR-3-32 type ¹ Phone jack ⁴
		-16dB			-36 dBu (12.3 mV)	-16 dBu (123 mV)	+4 dBu (1.23 V)	
	26dB	-34dB		600Ω Lines	-54 dBu (1.55 mV)	-34 dBu (15.5 mV)	-14 dBu (155 mV)	Phone jack ³
		+10dB			-20 dBu (245 mV)	+10 dBu (2.45 V)	+30 dBu (24.5 V)	
STEREO CH INPUT MGP32X: 25-32 MGP24X: 17-24	-34dB	+10dB	10kΩ	600Ω Lines	-54 dBu (1.55 mV)	-34 dBu (15.5 mV)	-14 dBu (155 mV)	Phone jack ⁴ RCA Pin Jack
					-10 dBu (245 mV)	+10 dBu (2.45 V)	+30 dBu (24.5 V)	
MONO CH INSERT INPUT MGP32X: 1-24 MGP24X: 1-16	-34dB	+10dB	10kΩ	600Ω Lines	-20 dBu (77.5 mV)	0 dBu (0.775 V)	+20 dBu (7.75 V)	Phone Jack ⁵
					-20 dBu (77.5 mV)	0 dBu (0.775 V)	+20 dBu (7.75 V)	
ST CH INSERT INPUT L,R	-34dB	+10dB	10kΩ	600Ω Lines	-20 dBu (77.5 mV)	0 dBu (0.775 V)	+20 dBu (7.75 V)	Phone Jack ⁵
TALKBACK INPUT	-34dB	+10dB	10kΩ	50-600Ω Mics	-66 dBu (0.389 mV)	-50 dBu (2.45 mV)	-30 dBu (24.5 mV)	XLR-3-31 type ⁶

0 dBu is referenced to 0.775 Vrms. 0 dBV is referenced to 1 Vrms.
*1 Sensitivity is the lowest level that will produce an output of +4 dB (1.23 V), or the nominal output level when the unit is set to maximum level. (All faders and level controls are at maximum position.)
*2 XLR-3-31 type connectors are balanced. (1=GND, 2=HOT, 3=COLD)
*3 Phone Jacks are balanced. (Tip=HOT, Ring=COLD, Sleeve=GND) *4 Phone Jacks are unbalanced.
*5 Phone Jacks are unbalanced. (Tip=Out, Ring=In, Sleeve=GND) *6 XLR-3-31 type connectors is unbalanced.

ANALOG OUTPUT SPECIFICATIONS						
Output terminal	Actual source impedance	For use with nominal	Output Level		Connector	
			Nominal	Max. before clip		
ST OUT [L,R]	75Ω	600Ω Lines	+4 dBu (1.23 V)	+24 dBu (12.3 V)	XLR3-32 type ¹ Phone jack ⁴	
MONO OUT	75Ω	600Ω Lines	+4 dBu (1.23 V)	+24 dBu (12.3 V)	XLR3-32 type ¹	
GROUP OUT (1-4)	150Ω	10kΩ Lines	+4 dBu (1.23 V)	+20 dBu (7.75 V)	Phone jack ²	
AUX SEND (1-6)	75Ω	600Ω Lines	+4 dBu (1.23 V)	+24 dBu (12.3 V)	XLR3-32 type ¹	
MATRIX OUT (1, 2)	150Ω	10kΩ Lines	+4 dBu (1.23 V)	+20 dBu (7.75 V)	Phone jack ²	
MONO CH INSERT OUT MGP32X: 1-24 MGP24X: 1-16	75Ω	10kΩ Lines	0 dBu (0.775 V)	+20 dBu (7.75 V)	Phone jack ³	
ST CH INSERT OUT [L,R]	75Ω	10kΩ Lines	0 dBu (0.775 V)	+20 dBu (7.75 V)	Phone jack ³	
MONITOR OUT [L,R]	150Ω	10kΩ Lines	+4 dBu (1.23 V)	+20 dBu (7.75 V)	Phone jack ²	
PHONES OUT	150Ω	40Ω Phones	3mW	75mW	ST Phone Jack	

0 dBu is referenced to 0.775 Vrms. 0 dBV is referenced to 1 Vrms.
*1 XLR-3-32 type connectors are balanced. (1=GND, 2=HOT, 3=COLD)
*2 Phone Jacks are impedance balanced. (Tip=HOT, Ring=COLD, Sleeve=GND)
*3 Phone Jacks are unbalanced. (Tip=Out, Ring=In, Sleeve=GND)
*4 Phone Jacks are balanced. (Tip=HOT, Ring=COLD, Sleeve=GND)

MGP16X MGP12X

ANALOG INPUT SPECIFICATIONS								
Input terminal	PAD	GAIN	Actual source impedance	For use with nominal	Input level			Connector
					Sensitivity ¹	Nominal	Max. before clip	
MONO CH INPUT MGP16X: 1-8 MGP12X: 1-4	0	-60dB	3kΩ	50-600Ω Mics	-80 dBu (0.078 mV)	-60 dBu (0.775 mV)	-40 dBu (7.75 mV)	Combo jack ²
		-16dB			-36 dBu (12.3 mV)	-16 dBu (123 mV)	+4 dBu (1.23 V)	
	26dB	-34dB		600Ω Lines	-54 dBu (1.55 mV)	-34 dBu (15.5 mV)	-14 dBu (155 mV)	XLR-3-31 type ³
		+10dB			-20 dBu (245 mV)	+10 dBu (2.45 V)	+30 dBu (24.5 V)	
STEREO CH INPUT MGP16X: 9-12 MGP12X: 5-8	-60dB	+10dB	3kΩ	50-600Ω Mics	-80 dBu (0.078 mV)	-60 dBu (0.775 mV)	-40 dBu (7.75 mV)	XLR-3-31 type ³
					-16dB	-36 dBu (12.3 mV)	-16 dBu (123 mV)	
	-34dB	+10dB	10kΩ	600Ω Lines	-54 dBu (1.55 mV)	-34 dBu (15.5 mV)	-14 dBu (155 mV)	Phone jack ⁴
					-10 dBu (245 mV)	+10 dBu (2.45 V)	+30 dBu (24.5 V)	
STEREO CH INPUT MGP16X: 13-16 MGP12X: 9-12	-34dB	+10dB	10kΩ	600Ω Lines	-54 dBu (1.55 mV)	-34 dBu (15.5 mV)	-14 dBu (155 mV)	Phone jack ⁴ RCA pin jack
					-10 dBu (245 mV)	+10 dBu (2.45 V)	+30 dBu (24.5 V)	
MONO CH INSERT IN MGP16X: 1-8 MGP12X: 1-4	-34dB	+10dB	10kΩ	600Ω Lines	-20 dBu (77.5 mV)	0 dBu (0.775 V)	+20 dBu (7.75 V)	TRS Phone Jack ⁵
RETURN (L, R)	-34dB	+10dB	10kΩ	600Ω Lines	-12 dBu (195 mV)	+4 dBu (1.23 V)	+24 dBu (12.3 V)	Phone Jack ⁴
2TR IN [L,R]	-34dB	+10dB	10kΩ	600Ω Lines	-26 dBV (50.1 mV)	-10 dBV (0.316 V)	+10 dBV (3.16 V)	RCA Pin Jack

0 dBu=0.775 Vrms, 0 dBV=1 Vrms
*1 Sensitivity: The lowest level that will produce an output of +4 dB (1.23 V), or the nominal output level when the unit is set to maximum level. (All faders and level controls are at their maximum position.)
*2 Combo jacks are balanced (1&Sleeve=GND, 2&Tip=HOT, 3&Ring=COLD)
*3 XLR-3-31 type connectors are balanced. (1=GND, 2=HOT, 3=COLD)
*4 Phone Jacks are unbalanced. *5 Phone Jacks are unbalanced. (Tip=Out, Ring=In, Sleeve=GND)

ANALOG OUTPUT SPECIFICATIONS						
Output terminal	Actual source impedance	For use with nominal	Output Level		Connector	
			Nominal	Max. before clip		
ST OUT [L,R]	75Ω	600Ω Lines	+4 dBu (1.23 V)	+24 dBu (12.3 V)	XLR3-32 type ¹ Phone jack ⁴	
GROUP OUT (1-4)	150Ω	10kΩ Lines	+4 dBu (1.23 V)	+20 dBu (7.75 V)	Phone jack ²	
AUX SEND (1, 2)	75Ω	600Ω Lines	+4 dBu (1.23 V)	+24 dBu (12.3 V)	XLR3-32 type ¹	
FX SEND (1, 2)	150Ω	10kΩ Lines	+4 dBu (1.23 V)	+20 dBu (7.75 V)	Phone jack ²	
MONO CH INSERT OUT MGP16X: 1-8 MGP12X: 1-4	150Ω	10kΩ Lines	0 dBu (0.775 V)	+20 dBu (7.75 V)	Phone jack ³	
REC OUT [L,R]	600Ω	10kΩ Lines	-10 dBV (0.316 V)	+10 dBV (3.16 V)	RCA Pin Jack	
MONITOR OUT [L,R]	150Ω	10kΩ Lines	+4 dBu (1.23 V)	+20 dBu (7.75 V)	Phone jack ²	
PHONES OUT	100Ω	40Ω Phones	3mW	75mW	ST Phone Jack	

0 dBu=0.775 Vrms, 0 dBV=1 Vrms
*1 XLR-3-32 type connectors are balanced. (1=GND, 2=HOT, 3=COLD)
*2 Phone Jacks are impedance balanced. (Tip=HOT, Ring=COLD, Sleeve=GND)
*3 Phone Jacks are unbalanced. (Tip=Out, Ring=In, Sleeve=GND)
*4 Phone Jacks are balanced. (Tip=HOT, Ring=COLD, Sleeve=GND)

Active Loudspeakers
DSR Series

DSR112 DSR115 DSR215 DSR118W

Active Loudspeakers
DXR Series

DXR8 DXR10 DXR12 DXR15

Active Subwoofers
DXS Series

DXS12 DXS15



Power up your rig with
Yamaha powered loudspeakers



MGP32X, MGP24X

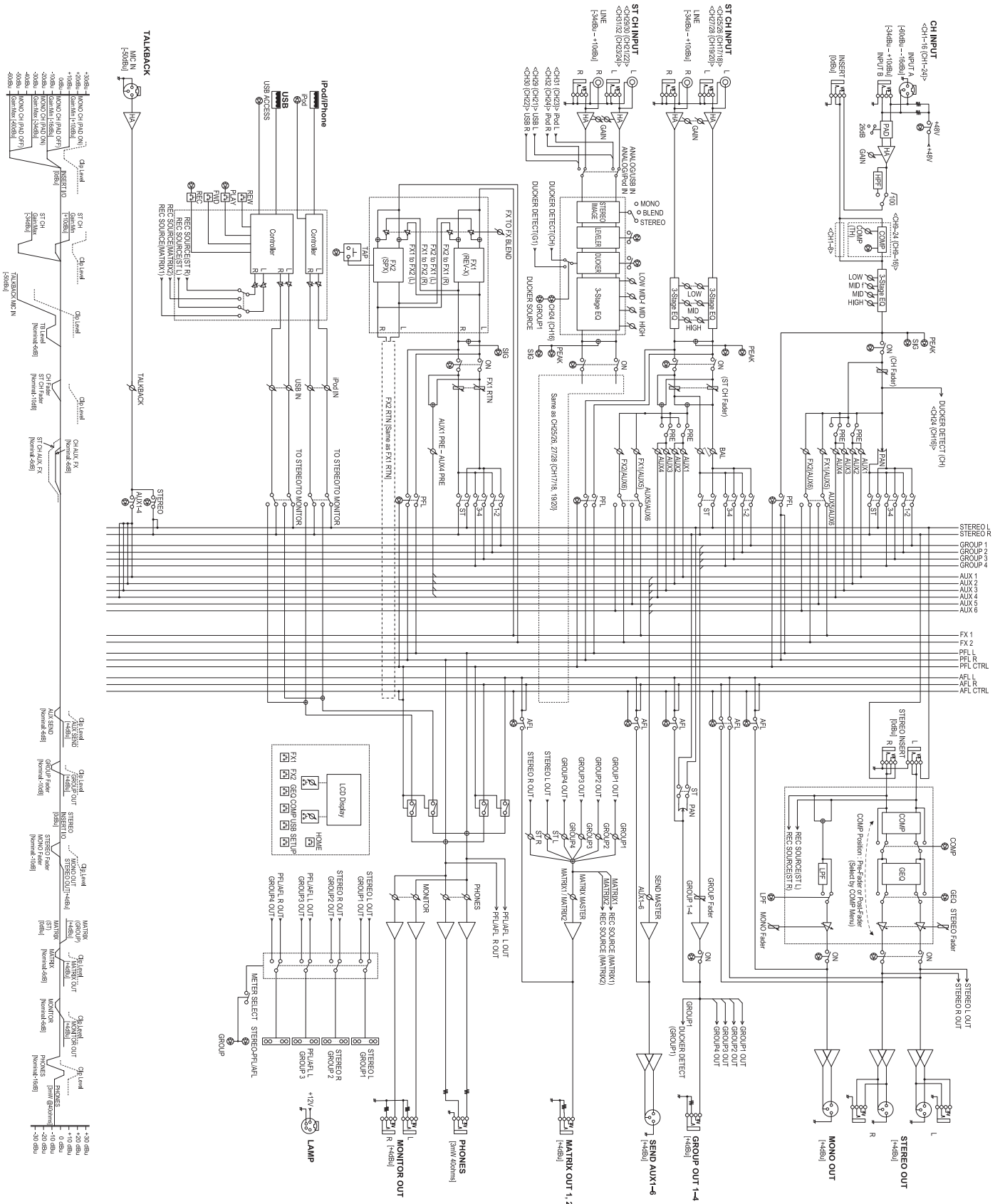

MGP16X, MGP12X

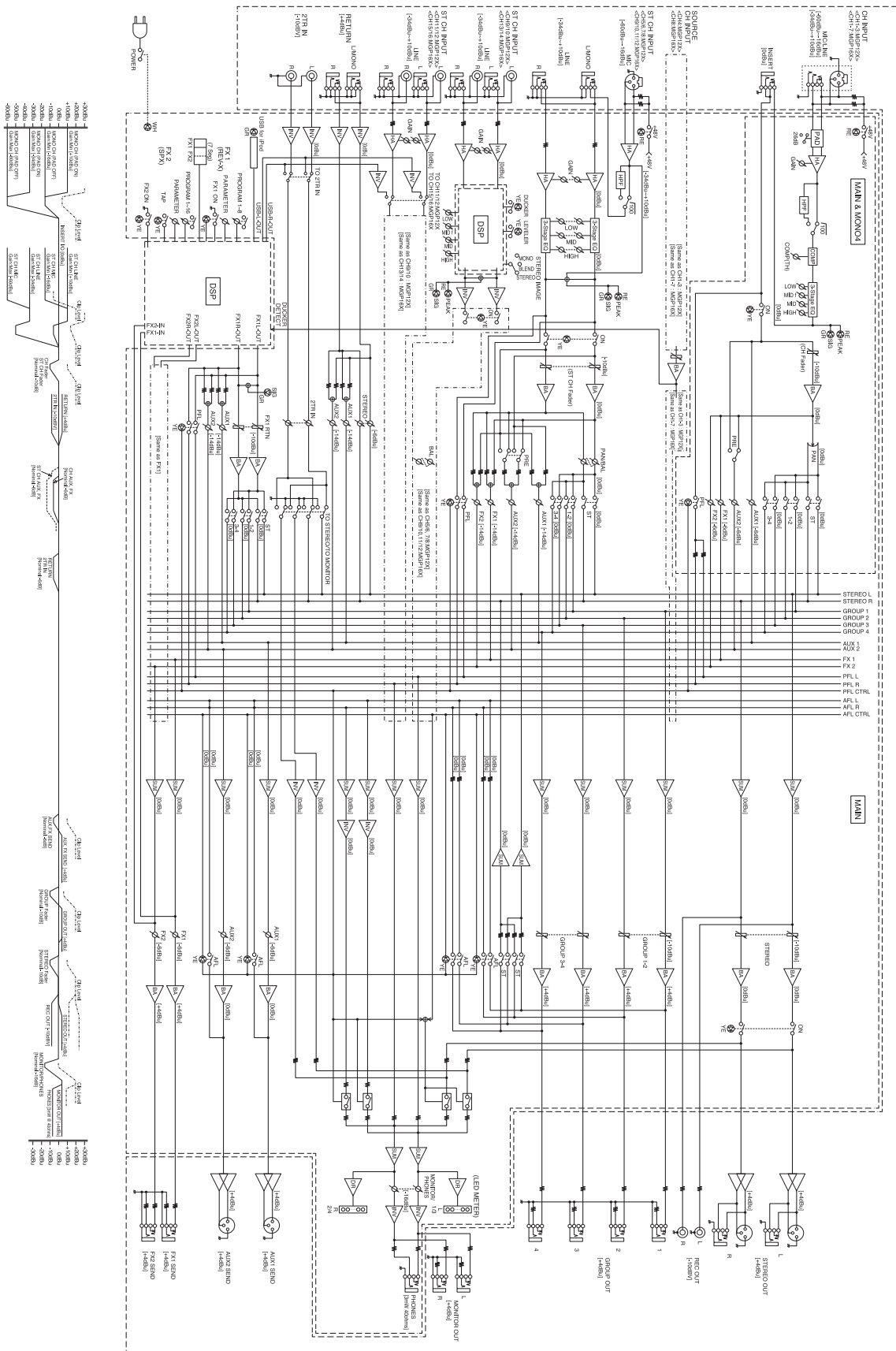



CREATING 'KANDO' TOGETHER

YAMAHA CORPORATION
P.O. BOX1, Hamamatsu Japan
www.yamahaproaudio.com

*Specifications and appearance are subject to change without notice.
*All trademarks and registered trademarks are property of their respective owners.

LPA617



P10025543

Printed in Japan

