



AV Receiver

*RX-A810*

Owner's Manual

Be sure to read "Safety Brochure" (supplied booklet) before using this unit.

**English for Asia, Africa, Oceania and Latin America**

# CONTENTS

## FEATURES

<b>What you can do with this unit</b> .....	<b>6</b>
<b>Part names and functions</b> .....	<b>8</b>
Front panel .....	8
Front display (indicators) .....	9
Rear panel .....	10
Remote control .....	11

## SETUP

<b>General setup procedure</b> .....	<b>12</b>
<b>1 Placing speakers</b> .....	<b>13</b>
<b>2 Connecting speakers</b> .....	<b>17</b>
Connecting front speakers that support bi-amp connections .....	19
<b>Input/output jacks and cables</b> .....	<b>20</b>
<b>3 Connecting a TV</b> .....	<b>21</b>
<b>4 Connecting playback devices</b> .....	<b>26</b>
Connecting video devices (BD/DVD players, etc.) .....	26
Connecting audio devices (CD players, etc.) .....	28
Connecting to the jacks on the front panel .....	29
<b>5 Connecting the FM/AM antennas</b> .....	<b>29</b>
<b>6 Connecting to the network</b> .....	<b>30</b>
<b>7 Connecting other devices</b> .....	<b>31</b>
Connecting an external power amplifier .....	31
Connecting video/audio recording devices .....	31
Connecting a device compatible with SCENE link playback (remote connection) .....	32
Connecting a device compatible with the trigger function .....	32
<b>8 Connecting the power cable</b> .....	<b>33</b>

<b>9 Selecting an on-screen menu language</b> .....	<b>34</b>
---	-----------

<b>10 Optimizing the speaker settings automatically (YPAO)</b> .....	<b>35</b>
--	-----------

Measuring at one listening position (single measure) .....	37
Measuring at multiple listening positions (multi measure) .....	38
Checking the measurement results .....	39
Reloading the previous YPAO adjustments .....	39
Error messages .....	40
Warning messages .....	41

## PLAYBACK

<b>Basic playback procedure</b> .....	<b>42</b>
---------------------------------------	-----------

Selecting an HDMI output jack .....	42
-------------------------------------	----

<b>Selecting the input source and favorite settings at once (SCENE)</b> ..	<b>43</b>
--	-----------

Configuring scene assignments .....	43
-------------------------------------	----

<b>Selecting the sound mode</b> .....	<b>44</b>
---------------------------------------	-----------

Enjoying sound field effects (CINEMA DSP) .....	45
Enjoying unprocessed playback .....	47
Enjoying pure high fidelity sound (Pure Direct) .....	48
Enjoying compressed music with enhanced sound (Compressed Music Enhancer) .....	48
Enjoying surround sound with headphones (SILENT CINEMA) .....	48

<b>Listening to FM/AM radio</b> .....	<b>49</b>
---------------------------------------	-----------

Setting the frequency steps .....	49
Selecting a frequency for reception .....	49
Registering favorite radio stations (preset) .....	50
Operating the radio on the TV .....	51

<b>Playing back iPod music/videos</b> .....	<b>52</b>
---	-----------

Connecting an iPod .....	52
Playback of iPod contents .....	54

<b>Playing back music via Bluetooth</b> .....	<b>57</b>
---	-----------

Connecting a Bluetooth receiver .....	57
Pairing Bluetooth components .....	57
Establishing a wireless connection and playing back .....	58

<b>Playing back music stored on a USB storage device</b> .....	<b>59</b>
Connecting a USB storage device .....	59
Playback of USB storage device contents .....	59
<b>Playing back music stored on PCs</b> .....	<b>62</b>
Media sharing setup .....	62
Playback of PC music contents .....	62
<b>Listening to Internet radio</b> .....	<b>65</b>
<b>Playing back music in multiple rooms (multi-zone)</b> .....	<b>67</b>
Preparing for Zone2 .....	67
Controlling Zone2 .....	69
<b>Useful functions</b> .....	<b>71</b>
Registering favorite items (shortcut) .....	71
Controlling this unit from the web browser (web control) .....	72
Viewing the current status .....	74
<b>Configuring settings in accordance with a playback source (Option menu)</b> ...	<b>75</b>
Option menu items .....	75

## CONFIGURATIONS

<b>Configuring input sources (Input menu)</b> .....	<b>78</b>
Input menu items .....	78
<b>Configuring the SCENE function (Scene menu)</b> .....	<b>81</b>
Scene menu items .....	81
<b>Configuring sound programs/surround decoders (Sound Program menu)</b> ...	<b>83</b>
Sound Program menu items .....	84
<b>Configuring various functions (Setup menu)</b> .....	<b>86</b>
Setup menu items .....	87
Speaker (Manual Setup) .....	89
Sound .....	92
Video .....	93
HDMI .....	94
Network .....	95
Multi Zone .....	96
Function .....	97
Language .....	99

<b>Viewing information about this unit (Information menu)</b> .....	<b>99</b>
Types of information .....	100
<b>Configuring the system settings (ADVANCED SETUP menu)</b> .....	<b>101</b>
ADVANCED SETUP menu items .....	101
Changing the speaker impedance setting (SP IMP.) .....	101
Selecting the remote control ID (REMOTE ID) .....	102
Changing the frequency step setting (TU) .....	102
Switching the video signal type (TV FORMAT) .....	102
Removing the limitation on HDMI video output (MON.CHK) .....	102
Restoring the default settings (INIT) .....	103
Updating the firmware (UPDATE) .....	103
Checking the firmware version (VERSION) .....	103
<b>Controlling external devices with the remote control</b> .....	<b>104</b>
Setting the remote control code for a TV .....	104
Setting the remote control codes for playback devices .....	105
Programming from other remote controls (learning) .....	106
Resetting remote control codes .....	107
<b>Updating the firmware of this unit</b> .....	<b>108</b>

## APPENDIX

<b>Frequently asked questions</b> .....	<b>109</b>
<b>Troubleshooting</b> .....	<b>110</b>
Power and system .....	110
Audio .....	111
Video .....	112
FM/AM radio .....	113
USB and network .....	113
Remote control .....	114
<b>Error indications on the front display</b> .....	<b>115</b>
<b>Ideal speaker layout</b> .....	<b>116</b>
<b>Glossary</b> .....	<b>117</b>
Audio information .....	117
Video information .....	119
Video signal flow .....	120

<b>Information on HDMI</b> .....	<b>121</b>
HDMI Control .....	121
HDMI signal compatibility .....	122
<b>Reference diagram (rear panel)</b> .....	<b>123</b>
<b>Trademarks</b> .....	<b>124</b>
<b>Specifications</b> .....	<b>125</b>

## Accessories

Check that the following accessories are supplied with this product.

### ■ Remote control

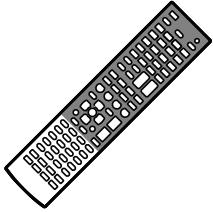

### ■ Batteries (AAA, R03, UM-4) (x 2)

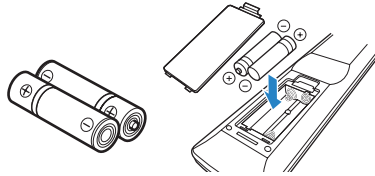

Insert into the remote control in the correct polarity (+/-)

### ■ YPAO microphone

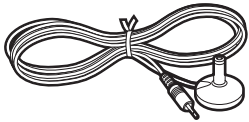

### ■ Power cable



\*The figure of the supplied power cable differs depending on regions.

### ■ AM antenna



### ■ FM antenna

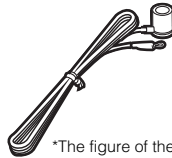

\*The figure of the supplied FM antenna differs depending on regions.

### ■ Easy Setup Guide



### ■ CD-ROM (Owner's Manual)



### ■ Safety Brochure



### Operating range of the remote control

- Aim the remote control directly at the remote control sensor on this unit during operation.

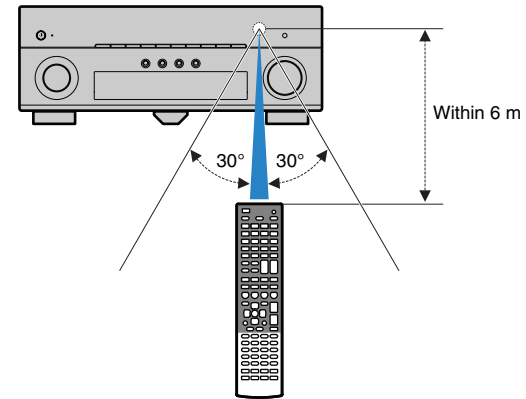

- Some features are not available in certain regions.
- Design and specifications are subject to change in part as a result of improvements, etc. In case of differences between the manual and product, the product has priority.
- This manual mainly explains operations using the supplied remote control.
- This manual describes both the "iPod" and "iPhone" as the "iPod". "iPod" means both "iPod" and "iPhone" unless the explanation describes exceptions.

• "!" indicates the cautions concerning operations or setup of the unit.

• "💡" indicates the explanations for better use.

# FEATURES

## What you can do with this unit

Ready for any kind of contents

iPod → p.52    Network → p.62 to p.65  
 USB → p.59    Bluetooth → p.57

\*Requires optional Bluetooth receiver for playback via Bluetooth

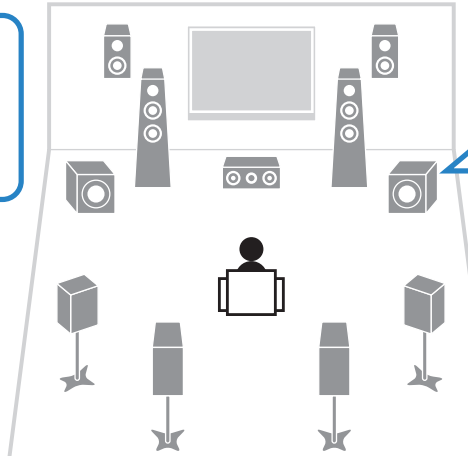
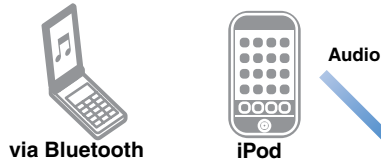

Supports 2 to 7.1 (plus presence) channel speaker system. Allows you to enjoy favorite acoustic spaces in various styles.  
 Automatically optimizing the speaker settings to suit your room (YPAO) → p.35  
 Sound field reproductions like actual movie theaters and concert halls from stereo or multi-channel audio sources (CINEMA DSP) → p.45  
 Enjoying compressed music with enhanced sound (Compressed Music Enhancer) → p.48

Speakers      Audio

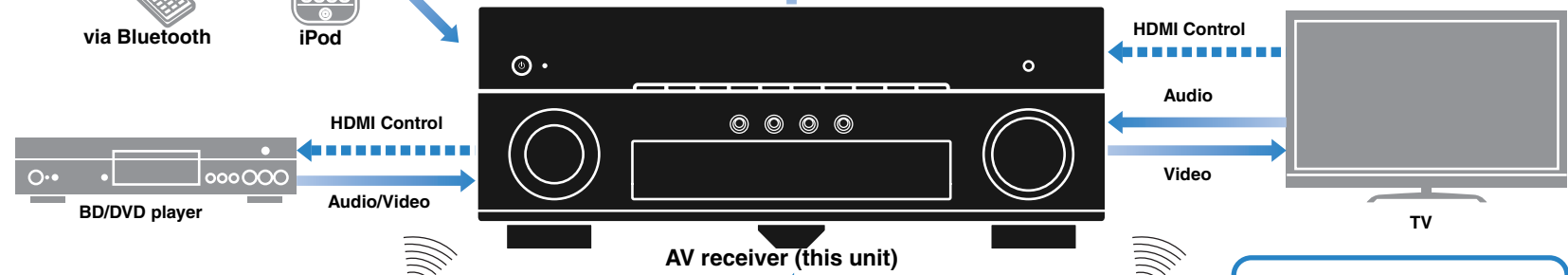

Operating external devices with the supplied remote control → p.104  
 Remote control of this unit

Selecting the input source and favorite settings at once (SCENE) → p.43

Operating the TV, AV receiver and BD/DVD player in combination (HDMI Control) → p.121  
 TV remote control

## Full of useful functions!

### ● Connecting various devices (p.26)

A number of HDMI jacks and various input/output jacks on this unit allow you to connect video devices such as BD/DVD players, audio devices such as CD players, game consoles and camcorders, and so on.

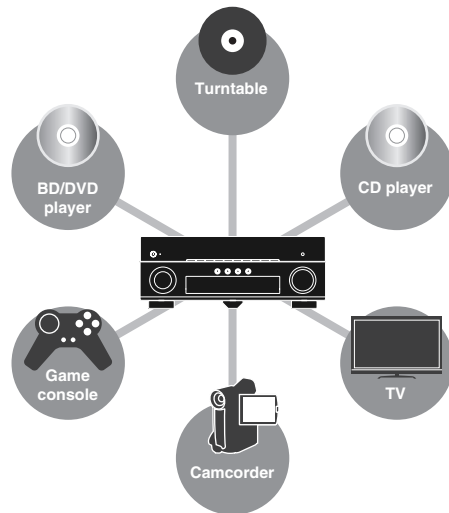

### ● Playing back TV audio in surround sound with a single HDMI cable connection (Audio Return Channel: ARC) (p.21)

When using a TV that supports ARC, you only need a single HDMI cable to connect the TV and this unit to output video to the TV, input audio from the TV, and transmit HDMI Control signals.

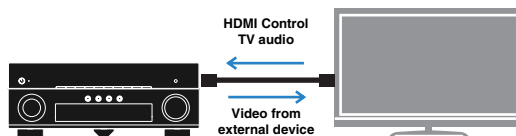

### ● Creating stereoscopic sound fields (p.47)

Connection of presence speakers enables to create a natural stereoscopic sound field in your room (CINEMA DSP 3D). Even when no presence speakers are connected, this unit automatically creates Virtual Presence Speaker (VPS) to produce 3D surround sound.

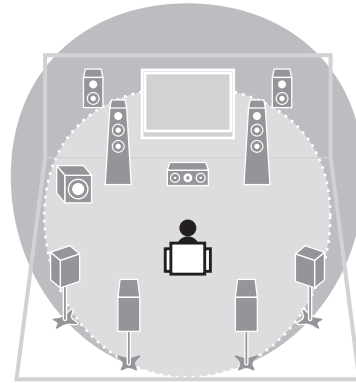

### ● Listening to FM/AM radio (p.49)

This unit is equipped with the built-in FM/AM tuner. You can register favorite radio stations as presets.

### ● Enjoying pure high fidelity sound (p.48)

When the Pure Direct mode is enabled, this unit plays back the selected source with the least circuitry. It allows you to enjoy Hi-Fi sound quality.

### ● Easy operation with a TV screen

You can navigate the various contents (iPod, USB, network, etc.), view the information, or configure the settings using the on-screen menu.

## At time like this

### The combination of video/audio input jacks prepared on this unit does not match an external device...

Use "Audio In" in the "Input" menu to change the combination of video/audio input jacks so that it match the output jack of your external device (p.27).

### Video and audio are not synchronized...

Use "Lipsync" in the "Setup" menu to adjust the delay between video and audio output (p.92).

### I want to hear audio from the TV speakers...

Use "Audio Output" in the "Setup" menu to select whether to output audio signals through this unit and the TV (p.95).

### I want to this unit to be turned off automatically when not in use...

Use "Auto Power Down" in the "Setup" menu to set the amount of time for auto-standby (p.97).

### I want to change the on-screen menu language...

Use "Language" in the "Setup" menu to select a language from English, Japanese, French, German, Spanish and Russian (p.99).

### I want to update the firmware...

Use "UPDATE" in the "ADVANCED SETUP" menu to update the firmware of this unit (p.103). If this unit is connected to the Internet, the corresponding message will be displayed on the TV when a newer firmware is available (p.108).

### There are many other settings to customize this unit.

#### For details, see the following pages.

- Input settings (p.78)
- Scene settings (p.81)
- Sound program and surround decoder settings (p.84)
- Various function settings (p.87)
- Information view (audio signal, video signal, etc.) (p.100)
- System settings (p.101)

# Part names and functions

## Front panel

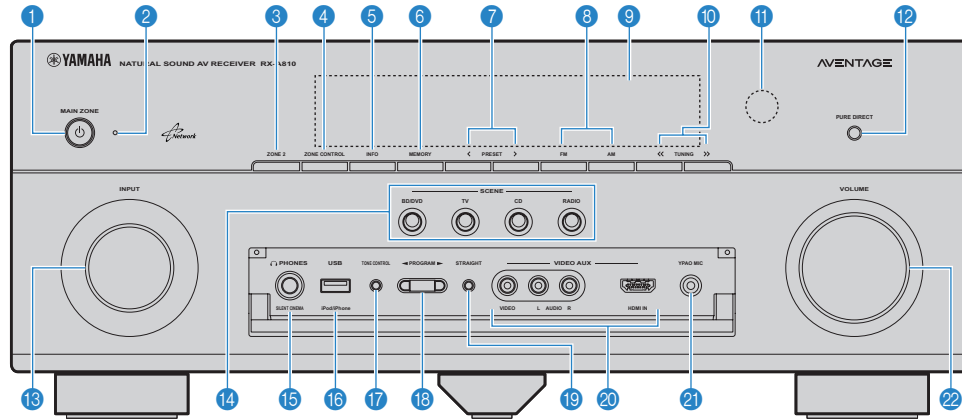

### Opening the front panel door

- To use controls or jacks behind the front panel door, gently press the bottom of the door to open it. Keep the door closed when not using controls or jacks behind the front panel door.

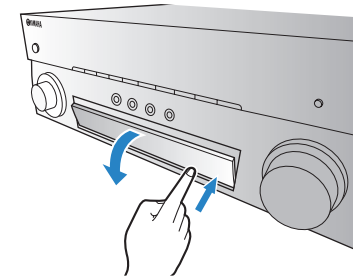

#### 1 MAIN ZONE

Turns on/off (standby) this unit.

#### 2 Standby indicator

Lights up when this unit is in standby mode under any of the following conditions.

- HDMI Control is enabled (p.121)
- The standby through function is enabled (p.95)
- The network standby function is enabled (p.96)
- The iPod is being charged (p.79)
- An iPod wireless system is connected (p.53)

#### 3 ZONE2

Enables/disables the audio output to Zone2 (p.69).

#### 4 ZONE CONTROL

Switches the zones (main or Zone2) to operate with the front panel controllers (p.69).

#### 5 INFO

Selects the information displayed on the front display (p.74).

#### 6 MEMORY

Registers FM/AM radio stations as preset stations (p.50).  
Registers USB/network contents as shortcuts (p.71).

#### 7 PRESET

Selects a preset FM/AM radio station (p.50).  
Selects a USB/network content from shortcuts (p.71).

#### 8 FM/AM

Switches between FM and AM (p.49).

#### 9 Front display

Displays information (p.9).

#### 10 TUNING

Selects the radio frequency (p.49).

#### 11 Remote control sensor

Receives remote control signals (p.5).

#### 12 PURE DIRECT

Enables/disables Pure Direct (p.48).

#### 13 INPUT

Selects an input source.

#### 14 SCENE

Selects the registered input source and sound program, and HDMI output at once. Additionally, you can turn on this unit when it is in standby mode (p.43).

#### 15 PHONES jack

For connecting headphones.

#### 16 USB jack

For connecting a USB storage device (p.59) or an iPod via USB (p.52).

#### 17 TONE CONTROL

Adjusts the high-frequency range and low-frequency range of sounds output from speakers and headphones (p.76).

#### 18 PROGRAM

Selects a sound program or a surround decoder (p.44).

#### 19 STRAIGHT

Enables/disables the straight decode mode (p.47).

#### 20 VIDEO AUX jacks

For connecting camcorders, game consoles, etc (p.29).

#### 21 YPAO MIC jack

For connecting the supplied YPAO microphone (p.35).

#### 22 VOLUME

Adjusts the volume.



## Front display (indicators)

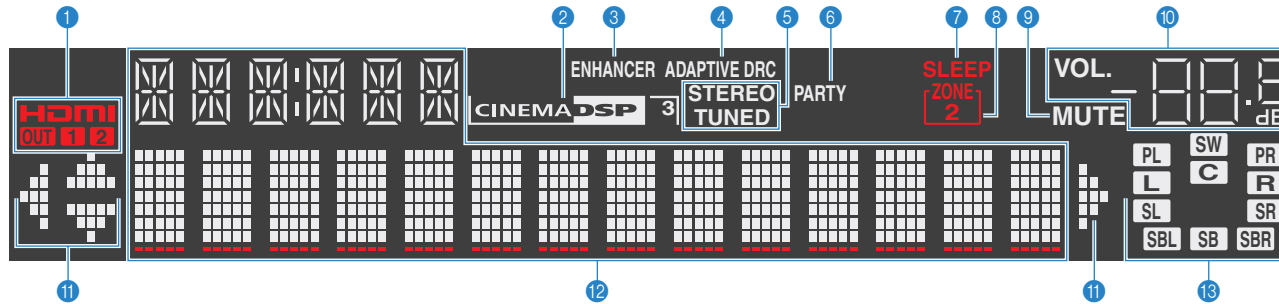

### 1 HDMI

Lights up when HDMI signals are being input or output.

#### OUT1/OUT2

Indicate the HDMI OUT jacks currently outputting an HDMI signal.

### 2 CINEMA DSP

Lights up when CINEMA DSP (p.45) is working.

#### CINEMA DSP 3D

Lights up when CINEMA DSP 3D (p.47) is working.

### 3 ENHANCER

Lights up when Compressed Music Enhancer (p.48) is working.

### 4 ADAPTIVE DRC

Lights up when Adaptive DRC (p.76) is working.

### 5 STEREO

Lights up when this unit is receiving a stereo FM radio signal.

#### TUNED

Lights up when this unit is receiving an FM/AM radio station signal.

### 6 PARTY

Lights up when this unit is in the party mode.

### 7 SLEEP

Lights up when the sleep timer is on.

### 8 ZONE 2

Lights up when the audio output to Zone2 is enabled.

### 9 MUTE

Flashes when audio is muted.

### 10 Volume indicator

Indicates the current volume.

### 11 Cursor indicators

Indicate the remote control cursor keys currently operational.

### 12 Information display

Displays the current status (input name, sound mode name, etc). You can switch the information by pressing INFO (p.74).

### 13 Speaker indicators

Indicate speaker terminals from which signals are output.

**L** Front speaker (L)

**R** Front speaker (R)

**C** Center speaker

**SL** Surround speaker (L)

**SR** Surround speaker (R)

**SBL** Surround back speaker (L)

**SBR** Surround back speaker (R)

**SB** Surround back speaker

**PL** Presence speaker (L)

**PR** Presence speaker (R)

**SW** Subwoofer

# Rear panel

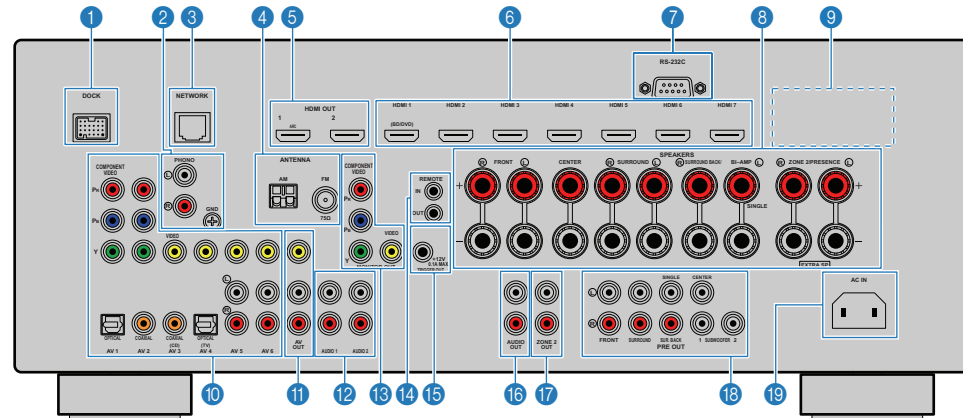

## 1 DOCK jack

For connecting an optional Yamaha products such as iPod dock (p.53), iPod wireless system (p.53), and Bluetooth receiver (p.57).

## 2 PHONO jacks

For connecting a turntable (p.28).

## 3 NETWORK jack

For connecting to the network (p.30).

## 4 ANTENNA jacks

For connecting FM and AM antennas (p.29).

## 5 HDMI OUT 1~2 jacks

For connecting HDMI-compatible TVs to output video/audio signals (p.21). When using ARC, TV audio signal is input through the HDMI OUT 1 jack.

## 6 HDMI1~7 jacks

For connecting HDMI-compatible playback devices to input video/audio signals (p.26).

## 7 RS-232C terminal

This is a control expansion terminal for custom installation. Consult your dealer for details.

## 8 SPEAKERS terminals

For connecting speakers (p.17).

## 9 VOLTAGE SELECTOR

(General model only)  
Select the switch position according to your local voltage (p.33).

## 10 AV1~6 jacks

For connecting video/audio playback devices to input video/audio signals (p.26).

## 11 AV OUT jacks

For outputting video/audio to a recording device (VCR, etc.) when an analog input (V-AUX, AV3~6 or AUDIO1~2) is selected (p.31).

## 12 AUDIO1~2 jacks

For connecting audio playback devices to input audio signals (p.28).

## 13 MONITOR OUT jacks

### COMPONENT VIDEO jack:

For connecting a TV compatible with component video to output video signals (p.25).

### VIDEO jack:

For connecting a TV compatible with composite video to output video signals (p.25).

## 14 REMOTE IN/OUT jacks

For connecting a Yamaha product compatible with SCENE link playback (p.32), or connecting an infrared signal receiver/emitter to operate devices including this unit from another room (p.68).

## 15 TRIGGER OUT jack

For connecting a device that supports the trigger function (p.32).

## 16 AUDIO OUT jacks

For outputting audio to a recording device (tape deck, etc.) when an analog input (V-AUX, AV5~6 or AUDIO1~2) is selected (p.31).

## 17 ZONE2 OUT jacks

For connecting external amplifier used in Zone2 to output audio (p.68).

## 18 PRE OUT jacks

For connecting a subwoofer with built-in amplifier or an external power amplifier (p.31).

## 19 AC IN

For connecting the supplied power cable (p.33).

# Remote control

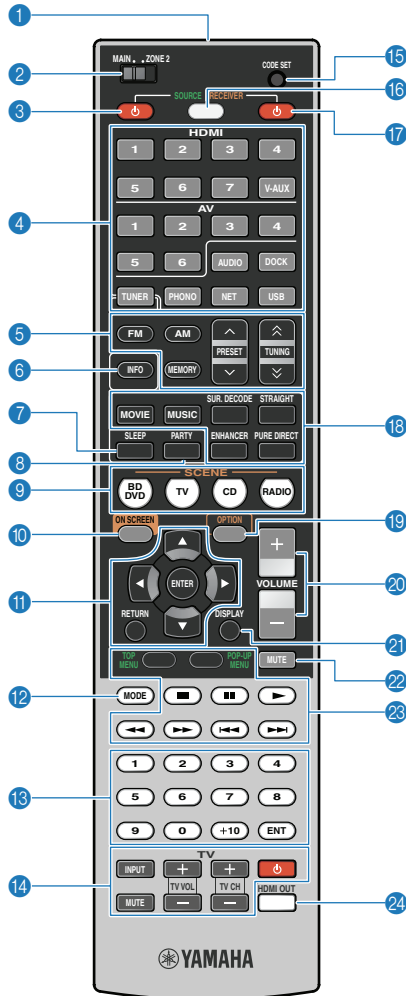

## 1 Remote control signal transmitter

Transmits infrared signals.

## 2 MAIN/ZONE2

Switches the zones (main or Zone2) to operate with the remote control (p.69).

## 3 SOURCE

Turns on/off an external device.

## 4 Input selection keys

Select an input source to play back.

- HDMI1~7** HDMI1~7 jacks
- V-AUX** VIDEO AUX jacks (on the front panel)
- AV1~6** AV1~6 jacks
- AUDIO** AUDIO1~2 jacks (press repeatedly to switch between "AUDIO1" and "AUDIO2")
- DOCK** DOCK jack
- TUNER** FM/AM radio
- PHONO** PHONO jacks
- NET** NETWORK jack (press repeatedly to select a desired network source)
- USB** USB jack (on the front panel)

## 5 Radio keys

Operate the FM/AM radio when "TUNER" is selected as the input source.

- FM** Switches to FM radio.
- AM** Switches to AM radio.
- MEMORY** Registers FM/AM radio stations as presets.
- PRESET** Selects a preset station.
- TUNING** Selects the radio frequency.

## 6 INFO

Selects the information displayed on the front display (p.74).

## 7 SLEEP

Switches this unit to standby mode automatically after a specified period of time has elapsed (sleep timer). Press repeatedly to set the time (120 min, 90 min, 60 min, 30 min, off).

## 8 PARTY

Turns on/off the party mode (p.70).

## 9 SCENE

Selects the assigned input source and sound program, and HDMI output at once. Additionally, you can turn on this unit when it is in standby mode (p.43).

## 10 ON SCREEN

Displays the on-screen menu on the TV.

## 11 Menu operation keys

- Cursor keys** Select a menu or a parameter.
- ENTER** Confirms a selected item.
- RETURN** Returns to the previous screen.

## 12 MODE

Switches between "Stereo" and "Mono" for FM radio reception. Switches the iPod operation modes (p.55).

## 13 Numeric keys

Enter numerical values such as radio frequencies.

## 14 TV operation keys

Operate TV input, TV volume, etc (p.104).

## 15 CODE SET

Registers remote control codes of external devices on the remote control (p.104).

## 16 SOURCE/RECEIVER

Switches the devices (this unit or external device) to operate with the remote control (p.105). You can operate this unit when this key lights up in orange, and an external device when this key lights up in green.

## 17 RECEIVER

Turns on/off (standby) this unit.

## 18 Sound mode keys

Select a sound mode (p.44).

## 19 OPTION

Displays the option menu (p.75).

## 20 VOLUME

Adjusts the volume.

## 21 DISPLAY

Display the status information on the TV (p.74).

## 22 MUTE

Mutes the audio output.

## 23 External device operation keys

Operate playback and menu display etc. for external devices (p.105).

## 24 HDMI OUT

Selects HDMI OUT jacks to be used for video/audio output (p.42).



- To operate external devices with the remote control, register a remote control code for each device in advance (p.104).

# SETUP

## General setup procedure

- 1 Placing speakers (p.13)** Select the speaker layout depending on the number of speakers and place the speakers in your room.
- 2 Connecting speakers (p.17)** Connect the speakers to this unit.
- 3 Connecting a TV (p.21)** Connect a TV to this unit.
- 4 Connecting playback devices (p.26)** Connect video devices (BD/DVD players, etc.) and audio devices (CD players, etc.) to this unit.
- 5 Connecting the FM/AM antennas (p.29)** Connect the supplied FM/AM antennas to this unit.
- 6 Connecting to the network (p.30)** Connect this unit to the network.
- 7 Connecting other devices (p.31)** Connect external devices such as an external power amplifier and recording devices.
- 8 Connecting the power cable (p.33)** After all the connections are complete, plug in the power cable.
- 9 Selecting an on-screen menu language (p.34)** Select a desired on-screen menu language (default: English).
- 10 Optimizing the speaker settings automatically (YPAO) (p.35)** Optimize the speaker settings such as volume balance and acoustic parameters to suit your room (YPAO).

Now all the preparations are complete. Enjoy playing movies, music, radio, etc. with this unit!

# 1 Placing speakers

Select the speaker layout depending on the number of speakers and place the speakers and subwoofer (with built-in amplifier) in your room. This section describes the representative speaker layout examples.

**Caution**

- This unit is configured for 8-ohm speakers at the factory. When connecting 6-ohm speakers, set the speaker impedance of this unit to "6 Ω MIN". In this case, you can also use 4-ohm speakers as the front speakers. For details, see "Setting the speaker impedance" (p.16).

Speaker type	Abbr.	Function	Speaker system (the number of channels)								
			7.1+2	7.1	7.1	6.1	5.1	4.1	3.1	2.1	
Front (L)	<b>FL</b>	Produce front right/left channel sounds (stereo sounds).	●	●	●	●	●	●	●	●	●
Front (R)	<b>FR</b>		●	●	●	●	●	●	●	●	●
Center	<b>C</b>	Produces center channel sounds (dialogs, vocals, etc).	●	●	●	●	●			●	
Surround (L)	<b>SL</b>	Produce surround right/left channel sounds. Surround speakers also produce surround back channel sounds when no surround back speakers are connected.	●	●	●	●	●	●			
Surround (R)	<b>SR</b>		●	●	●	●	●	●			
Surround back (L)	<b>SBL</b>	Produce surround back right/left channel sounds.	●	●							
Surround back (R)	<b>SBR</b>		●	●							
Surround back	<b>SB</b>	Produces mixed-down surround back right/left channel sounds.				●					
Presence (L)	<b>PL</b>	Produce CINEMA DSP effect sounds. In combination with CINEMA DSP 3D (p.47), the presence speakers create a natural stereoscopic sound field in your room.	●		●						
Presence (R)	<b>PR</b>		●		●						
Subwoofer	<b>SW</b>	Produces LFE (low-frequency effect) channel sounds and reinforces bass parts of other channels. This channel is counted as "0.1". You can connect 2 subwoofers (with built-in amplifier) to this unit.	●	●	●	●	●	●	●	●	●



- For information on the ideal speaker layout, see "Ideal speaker layout" (p.116).
- If you have 7 speakers, use two of them as surround back speakers or presence speakers. To reinforce the rear right/left sounds, use them as surround back speakers. To create a natural stereoscopic sound field, use them as presence speakers.
- 2 subwoofers connected to this unit output same sounds.

## 7.1+2 channel system

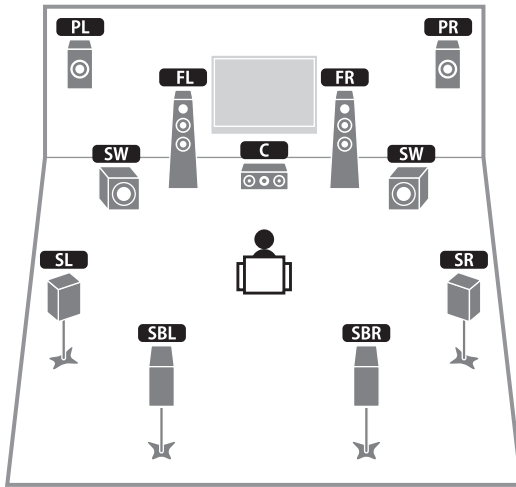

- The surround back speakers and presence speakers do not produce sounds simultaneously. This unit automatically switches the speakers to be used depending on a selected CINEMA DSP (p.45).

## 7.1 channel system (using surround back speakers)

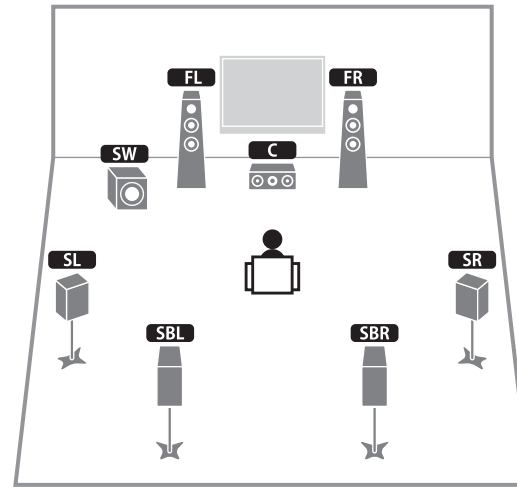

## 7.1 channel system (using presence speakers)

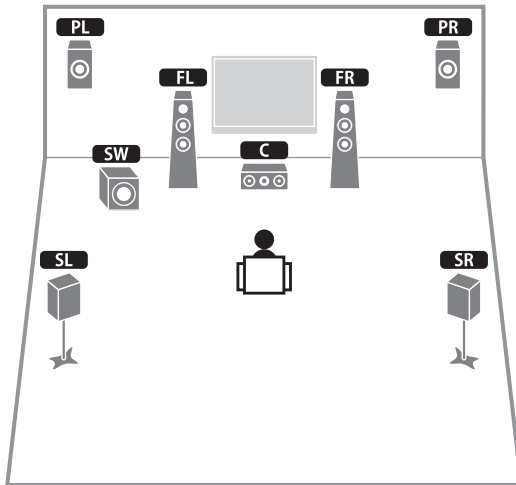

## 6.1 channel system

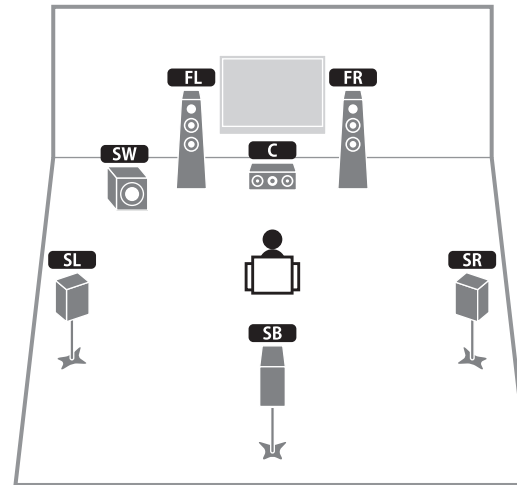

### 5.1 channel system

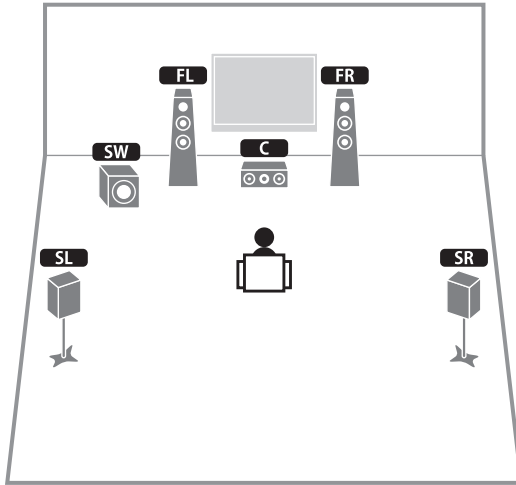

### 4.1 channel system

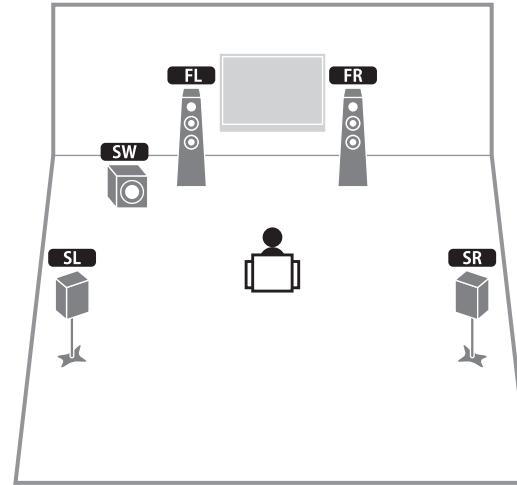

### 3.1 channel system

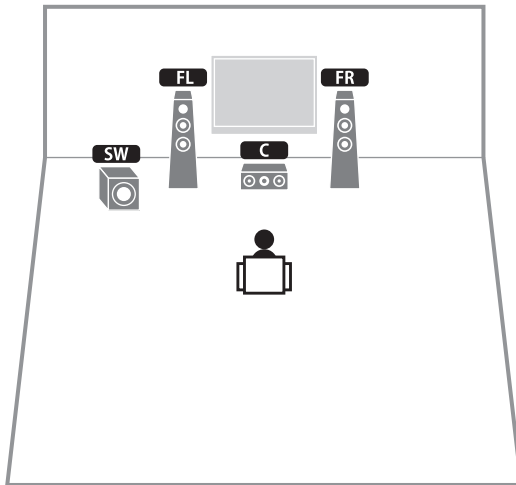

### 2.1 channel system

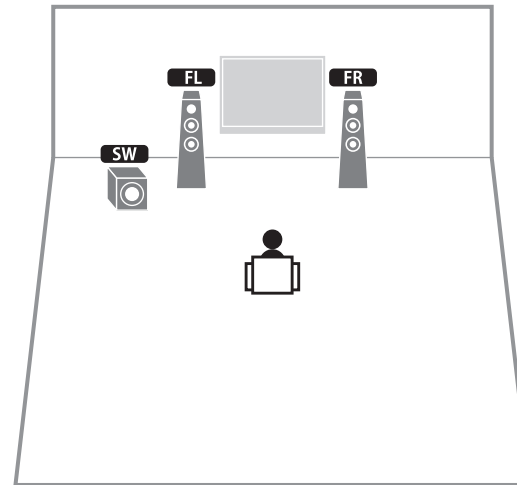

## ■ Setting the speaker impedance

This unit is configured for 8-ohm speakers at the factory. When connecting 6-ohm speakers, set the speaker impedance to "6 Ω MIN". In this case, you can also use 4-ohm speakers as the front speakers.

- 1 Before connecting speakers, connect the supplied power cable to this unit and then to an AC wall outlet.
- 2 While holding down STRAIGHT on the front panel, press MAIN ZONE ⏻.

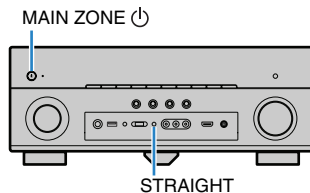

- 3 Check that "SP IMP." is displayed on the front display.



- 4 Press STRAIGHT to select "6 Ω MIN".
- 5 Press MAIN ZONE ⏻ to set this unit to standby mode and remove the power cable from the AC wall outlet.

Now you are ready to connect the speakers.



## 2 Connecting speakers

Connect the speakers placed in your room to the unit. Here are connections of 7.1+2, 7.1 and 6.1 channel system as examples. If you select another system, connect speakers while referring to the connection of 6.1 channel system.

### Caution

- Remove the power cable of this unit from an AC wall outlet and turn off the subwoofer before connecting the speakers.
- Be careful that the core of the speaker cable does not touch anything or come into contact with the metal areas of this unit. This may damage this unit or the speakers. If the speaker cables short circuit, "CHECK SP WIRES" will appear on the front display when this unit is turned on.

### Cables necessary for connection (commercially available)

Speaker cables (x the number of speakers)



Audio pin cable (2 for connecting 2 subwoofers)



### 7.1+2 channel system

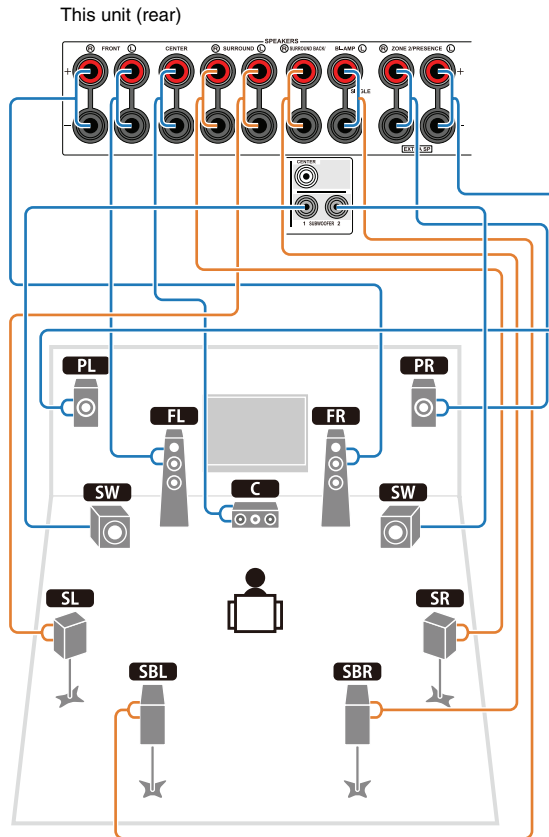

### 7.1 channel system (using surround back speakers)

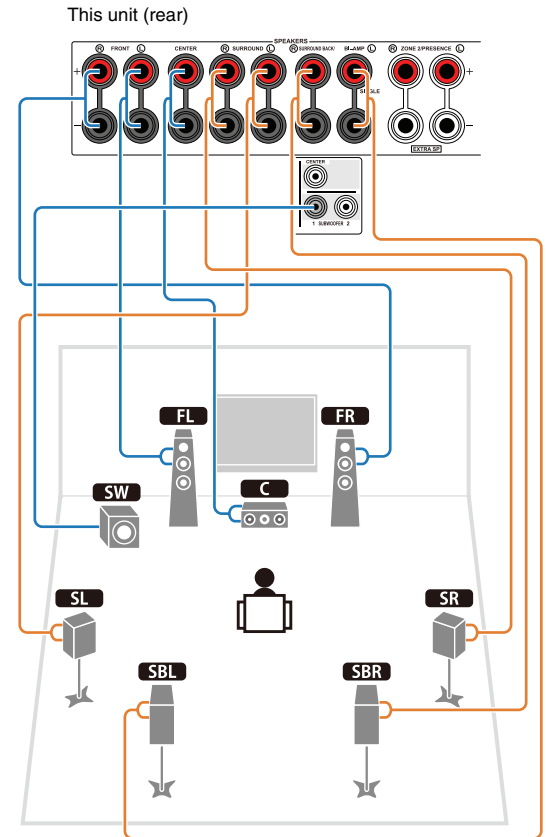

## 7.1 channel system (using presence speakers)

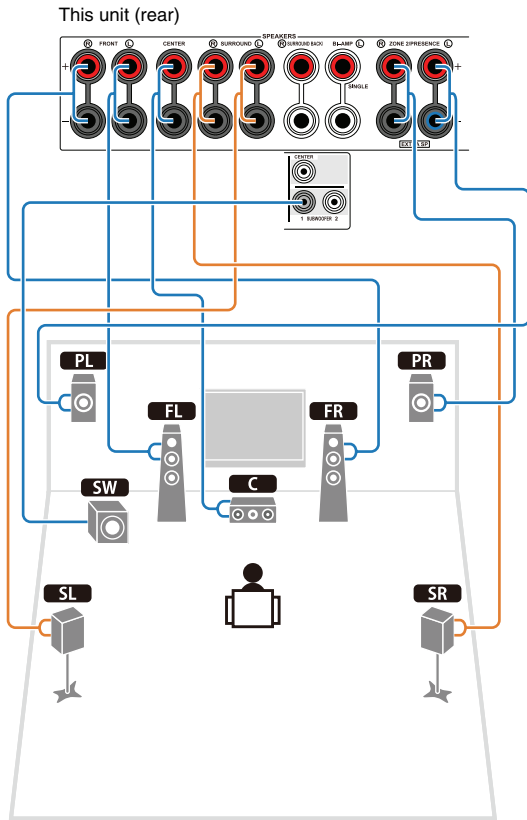

## 6.1 channel system

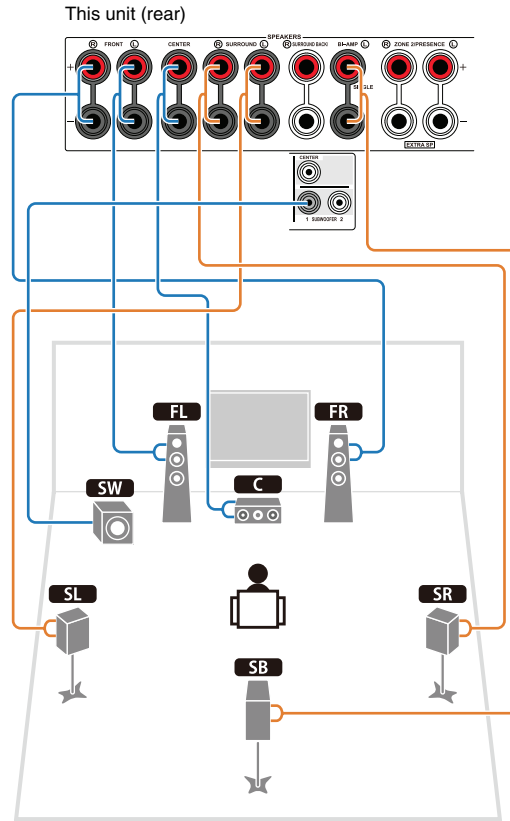

When using only one surround back speaker, connect it to the SINGLE jack (L side).

## ■ Connecting speaker cables

Speaker cables have two wires. One is for connecting the negative (-) terminal of the unit and the speaker, and the other is for the positive (+) terminal. If the wires are colored to prevent confusion, connect the black wire to the negative and the other wire to the positive.

- ① Remove approximately 10 mm of insulation from the ends of the speaker cable, and twist the bare wires of the cable together firmly.
- ② Loosen the speaker terminal.
- ③ Insert the bare wires of the cable into the gap on the side (upper right or bottom left) of the terminal.
- ④ Tighten the terminal.

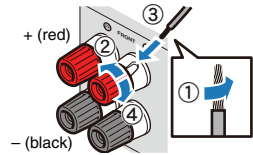

### Using a banana plug

(China, Australia and General models only)

- ① Tighten the speaker terminal.
- ② Insert a banana plug into the end of the terminal.

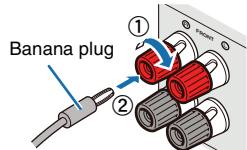

## ■ Connecting the subwoofer

Use an audio pin cable to connect the subwoofer.

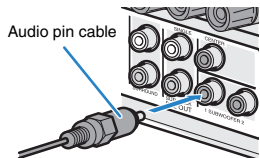

## Connecting front speakers that support bi-amp connections

When using front speakers that support bi-amp connections, connect them to the FRONT jacks and SURROUND BACK/BI-AMP jacks.

To enable the bi-amp function, set "Power Amp Assign" (p.89) in the "Setup" menu to "5ch BI-AMP" after connecting the power cable to an AC wall outlet.

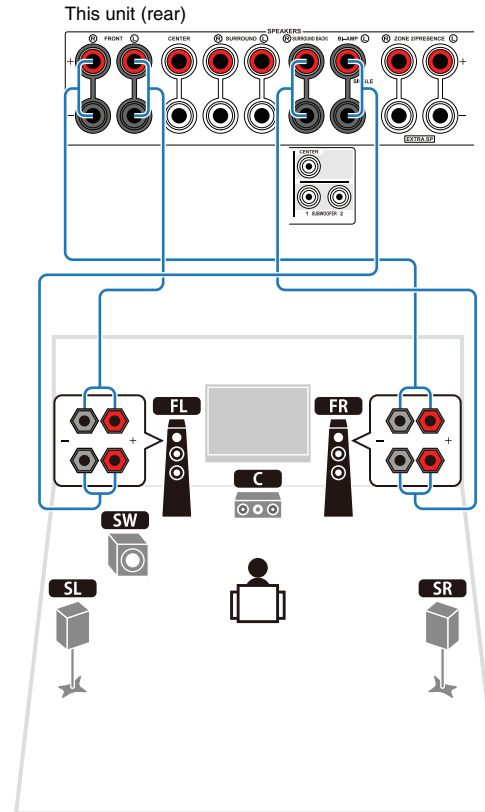

### Caution

- Before making bi-amp connections, remove any brackets or cables that connect a woofer with a tweeter. Refer to the instruction manual of the speakers for details. When not making bi-amp connections, make sure that the brackets or cables are connected before connecting the speaker cables.
- When using bi-amp connections, surround back speakers cannot be used.

# Input/output jacks and cables

## Video/audio jacks

### HDMI jacks

Transmit digital video and digital sound through a single jack. Use an HDMI cable.

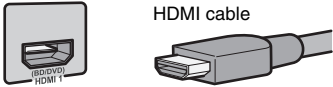

- Use a 19-pin HDMI cable with the HDMI logo. We recommend using a cable less than 5.0 m long to prevent signal quality degradation.
- To connect a device that has a DVI jack, an HDMI/DVI-D cable is required.



- The HDMI jacks of this unit support the HDMI Control, Audio Return Channel (ARC), and 3D video transmission (through output) features.

## Video jacks

### COMPONENT VIDEO jacks

Transmit video signals separated into three components: luminance (Y), chrominance blue (PB), and chrominance red (PR). Use a component video cable with three plugs.

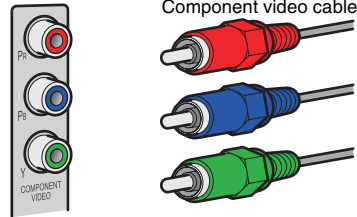

### VIDEO jacks

Transmit analog video signals. Use a video pin cable.

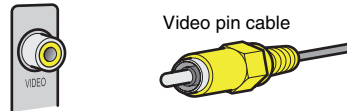

## Audio jacks

### OPTICAL jacks

Transmit digital audio signals. Use a digital optical cable. Remove the tip protector (if available) before using the cable.



### COAXIAL jacks

Transmit digital audio signals. Use a digital coaxial cable.



### AUDIO jacks

Transmit analog stereo audio signals. Use a stereo pin cable.

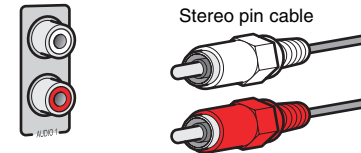

### 3 Connecting a TV

Connect a TV to this unit so that videos input to this unit can be output to the TV. You can also enjoy playback of TV audio on this unit. The connection method varies depending on functions and video input jacks available on your TV. Refer to the instruction manual of the TV and choose a connection method.

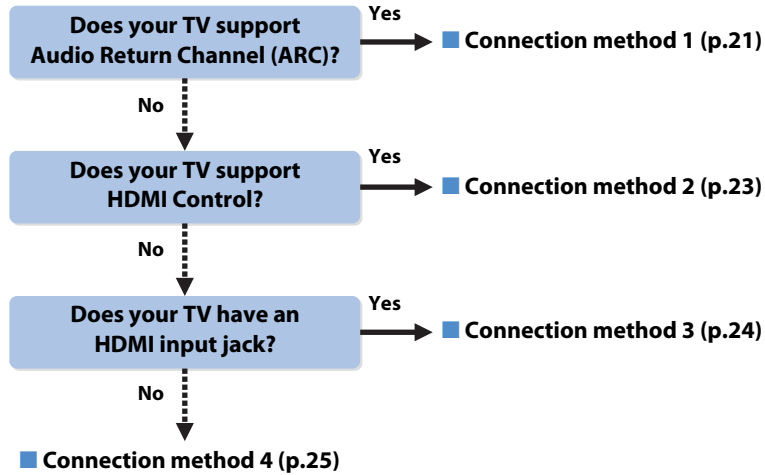

#### About HDMI Control

HDMI Control allows you to operate external devices via HDMI. If you connect a TV that supports HDMI Control to this unit with an HDMI cable, you can control this unit (power, volume, etc.) in conjunction with TV remote control operations. You can also control playback devices (HDMI Control-compatible BD/DVD player, etc.) connected to this unit with an HDMI cable. For details, see "HDMI Control" (p.121).

#### About Audio Return Channel (ARC)

ARC allows audio signals to travel both ways under HDMI Control. So if you connect a TV that supports HDMI Control and ARC to this unit with a single HDMI cable, you can output video/audio to the TV or input TV audio to this unit.

#### ■ Connection method 1 (HDMI Control/ARC-compatible TV)

Connect the TV to this unit with an HDMI cable.



- The following explanation is based on the assumption that you have not changed the "HDMI" parameters (p.94) in the "Setup" menu.
- HDMI Control is available only on the HDMI OUT 1 jack.

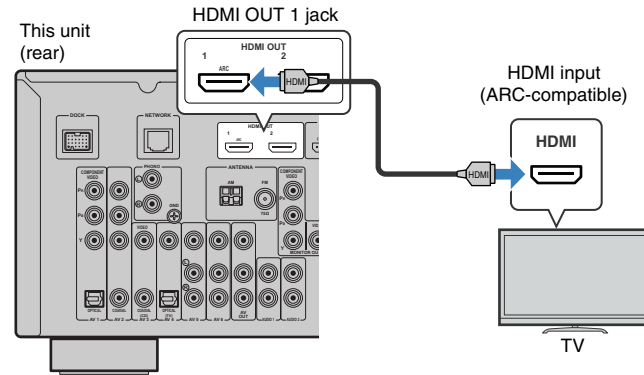

- If you make an HDMI connection between your TV and this unit, any videos input to this unit can be output to the TV no matter how you connect video devices to this unit. For details, see "Video signal flow" (p.120).
- You can connect another TV or a projector by using the HDMI OUT 2 jack (p.25).

## Necessary settings

To use HDMI Control and ARC, you need to configure the following settings.  
For details on settings and operations of your TV, refer to the instruction manual of the TV.

### 1 After connecting external devices (TV, playback devices, etc.) and power cable of this unit, turn on this unit, TV and playback devices.

### 2 Configure the settings of this unit.

- ① Check that ARC is enabled on the TV.
- ② Switch the TV input to display the video from this unit.
- ③ Press ON SCREEN.

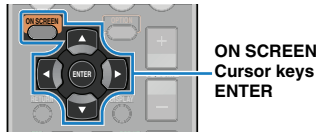

- ④ Use the cursor keys to select "Setup" and press ENTER.

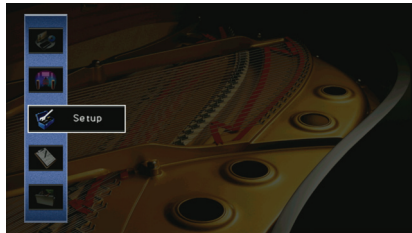

- ⑤ Use the cursor keys (</>) to select "HDMI".



- ⑥ Use the cursor keys (Δ/▽) to select "HDMI Control" and press ENTER.
- ⑦ Use the cursor keys to select "On".
- ⑧ Press ON SCREEN.

### 3 Configure the settings for HDMI Control.

- ① Enable HDMI Control on the TV and playback devices (HDMI Control-compatible BD/DVD player, etc).
- ② Turn off the main power of the TV and then turn off this unit and playback devices.
- ③ Turn on the main power of the TV and then turn on this unit and playback devices.
- ④ Switch the TV input to display the video from this unit.
- ⑤ Check the followings.

**On this unit:** The input to which the playback device is connected is selected. If not, select the input source manually.

**On the TV:** The video from the playback device is displayed.

- ⑥ Check that this unit is properly synchronized with the TV by turning off the TV or adjusting the TV volume with the TV remote control.

Now the necessary settings are complete.

If you select a TV program with the TV remote control, the input source of this unit will be automatically switched to "AV4" and the TV audio will be played back on this unit.

If TV audio cannot be heard, check that "ARC" (p.94) in the "Setup" menu is set to "On".



- If HDMI Control does not work properly, try turning off and on (or unplugging and re-plugging) the devices. It may solve the problem.
- If any audio interruption happens while using ARC, set "ARC" (p.94) in the "Setup" menu to "Off" and use a digital optical cable to input TV audio to this unit (p.23).



- "AV4" is set as TV audio input at the factory. If you have connected any external device to the AV4 jacks, use "TV Audio Input" (p.94) in the "Setup" menu to change the TV audio input assignment. To use the SCENE function (p.43), you also need to change the input assignment for SCENE(TV).

## ■ Connection method 2 (HDMI Control-compatible TV)

Connect the TV to this unit with an HDMI cable and a digital optical cable.



- The following explanation is based on the assumption that you have not changed the "HDMI" parameters (p.94) in the "Setup" menu.
- HDMI Control is available only on the HDMI OUT 1 jack.

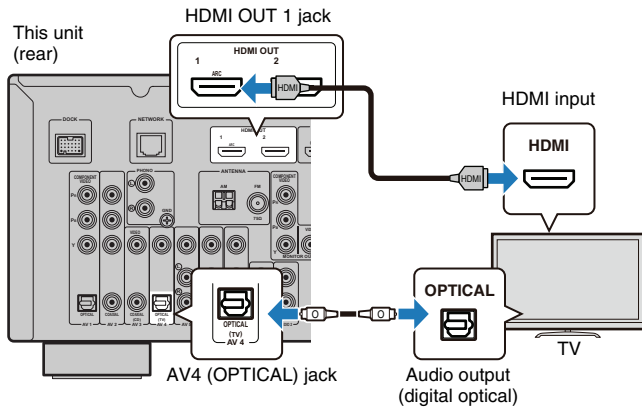

- If you make an HDMI connection between your TV and this unit, any videos input to this unit can be output to the TV no matter how you connect video devices to this unit. For details, see "Video signal flow" (p.120).
- You can connect another TV or a projector by using the HDMI OUT 2 jack (p.25).

## Necessary settings

To use HDMI Control, you need to configure the following settings.

For details on settings and operations of your TV, refer to the instruction manual of the TV.

### 1 After connecting external devices (TV, playback devices, etc.) and power cable of this unit, turn on this unit, TV and playback devices.

### 2 Configure the settings of this unit.

① Switch the TV input to display the video from this unit.

② Press ON SCREEN.

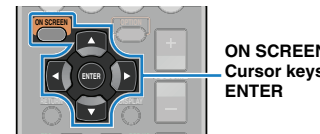

③ Use the cursor keys to select "Setup" and press ENTER.

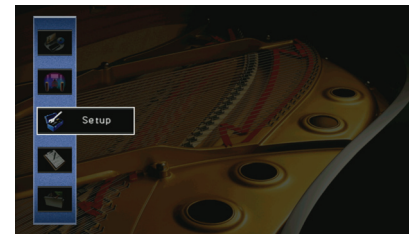

④ Use the cursor keys (</>) to select "HDMI".



⑤ Use the cursor keys (△/▽) to select "HDMI Control" and press ENTER.

⑥ Use the cursor keys to select "On".

⑦ Press ON SCREEN.

### 3 Configure the settings for HDMI Control.

- ① Enable HDMI Control on the TV and playback devices (HDMI Control-compatible BD/DVD player, etc).
- ② Turn off the main power of the TV and then turn off this unit and playback devices.
- ③ Turn on the main power of the TV and then turn on this unit and playback devices.
- ④ Switch the TV input to display the video from this unit.
- ⑤ Check the followings.

**On this unit:** The input to which the playback device is connected is selected. If not, select the input source manually.

**On the TV:** The video from the playback device is displayed.

- ⑥ Check that this unit is properly synchronized with the TV by turning off the TV or adjusting the TV volume with the TV remote control.

Now the necessary settings are complete.

If you select a TV program with the TV remote control, the input source of this unit will be automatically switched to “AV4” and the TV audio will be played back on this unit.



- If HDMI Control does not work properly, try turning off and on (or unplugging and re-plugging) the devices. It may solve the problem.



- “AV4” is set as TV audio input at the factory. If you have connected any external device to the AV4 jacks or if you want to use another input jack (other than OPTICAL) for connecting the TV, use “TV Audio Input” (p.94) in the “Setup” menu to change the TV audio input assignment. To use the SCENE function (p.43), you also need to change the input assignment for SCENE(TV).

### ■ Connection method 3 (TV with HDMI input jacks)

Connect the TV to this unit with an HDMI cable and a digital optical cable.

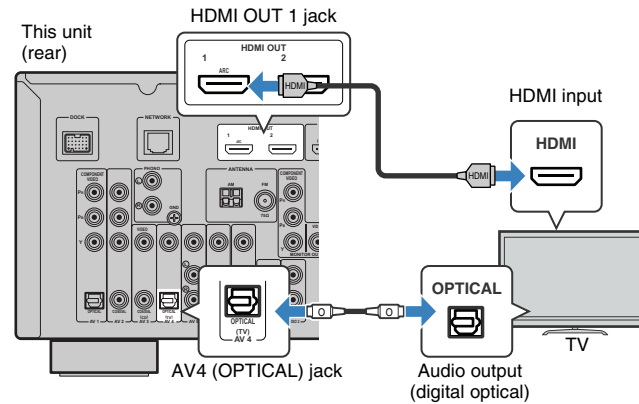

If switch the input source of this unit to “AV4” by pressing AV4 or SCENE(TV), the TV audio will be played back on this unit.



- If you make an HDMI connection between your TV and this unit, any videos input to this unit can be output to the TV no matter how you connect video devices to this unit. For details, see “Video signal flow” (p.120).
- You can connect another TV or a projector by using the HDMI OUT 2 jack (p.25).
- If you have connected any external device to the AV4 jacks or if you want to use another input jack (other than OPTICAL) for connecting the TV, connect the TV to one of the AV1~6 and AUDIO1~2 jacks. To use the SCENE function (p.43), you also need to change the input assignment for SCENE(TV).



### ■ Connection method 4 (TV without HDMI input jacks)

Depending on the video input jacks available on your TV, choose one of the following connections.

If you select "AV4" as the input source by pressing AV4 or SCENE(TV), the TV audio will be played back on this unit.



- If you connect your TV to this unit with a cable other than HDMI, videos input to this unit via HDMI cannot be output to the TV. Also, analog videos that can be output to the TV differ according to the "Analog to Analog Conversion" setting. For details, see "Video signal flow" (p.120).



- If you have connected any external device to the AV4 jacks or if you want to use another input jack (other than OPTICAL) for connecting the TV, connect the TV to one of the AV1~6 and AUDIO1~2 jacks. To use the SCENE function (p.43), you also need to change the input assignment for SCENE(TV).

### COMPONENT VIDEO connection (with a component video cable)

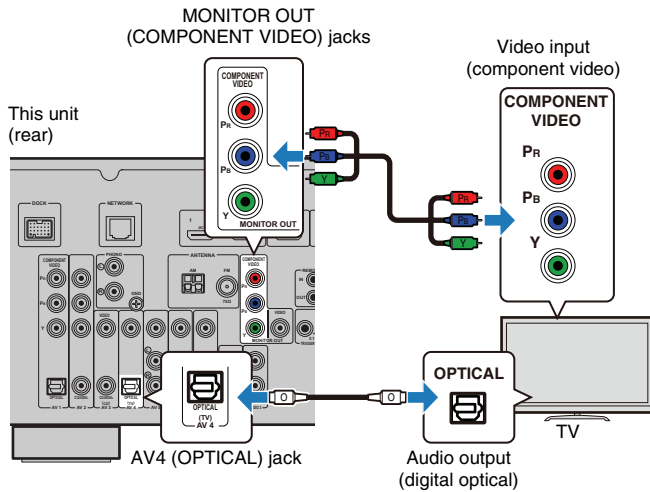

### VIDEO (composite video) connection (with a video pin cable)

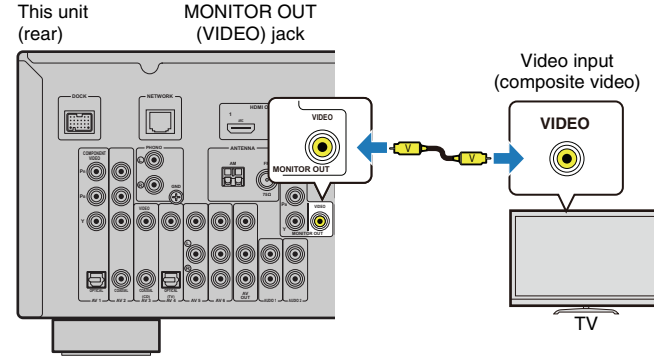

### ■ Connecting another TV or a projector

This unit has 2 HDMI output jacks. If you connect another TV or a projector to this unit with an HDMI cable, you can switch the TVs (or projector) to be used for watching videos with the remote control (p.42).

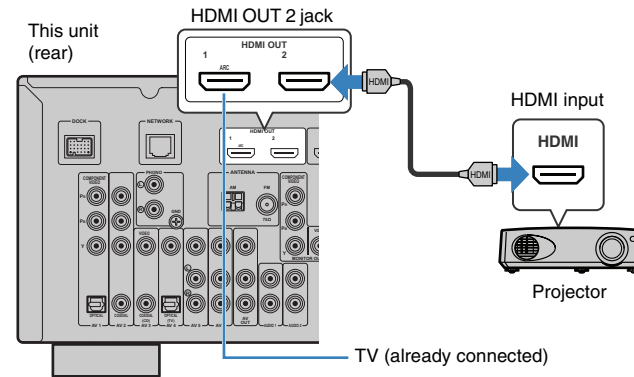

- HDMI Control is not available on the HDMI OUT 2 jack.

## 4 Connecting playback devices

This unit is equipped with a variety of input jacks including HDMI input jacks to allow you to connect different types of playback devices. For information on how to connect an iPod, a Bluetooth component or a USB storage device, see the following pages.

- Connecting an iPod (p.52)
- Connecting a Bluetooth receiver (p.57)
- Connecting a USB storage device (p.59)

### Connecting video devices (BD/DVD players, etc.)

Connect video devices such as BD/DVD players, set-top boxes (STBs) and game consoles to this unit. Depending on the video/audio output jacks available on your video device, choose one of the following connections. We recommend using an HDMI connection if the video device has an HDMI output jack.



- Videos input to this unit via HDMI cannot be output to a TV connected to this unit with a cable other than HDMI.



- If the combination of video/audio input jacks prepared on this unit does not match your video device, change its combination according to the output jacks of your device (p.27).

### HDMI connection

Connect a video device to this unit with an HDMI cable.

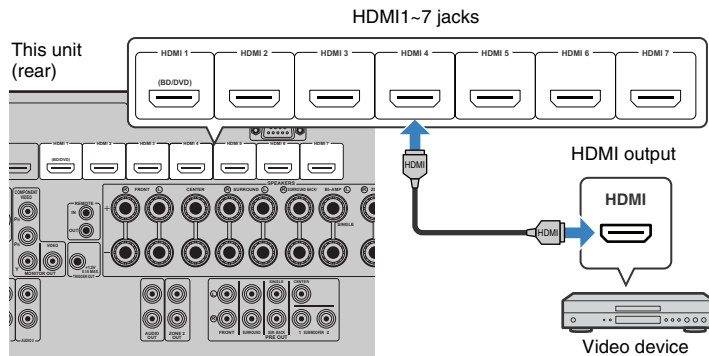

If you select the input source by pressing HDMI1~7, the video/audio played back on the video device will be output from this unit.

### Component video connection

Connect a video device to this unit with a component video cable and an audio cable (digital optical or digital coaxial). Choose a set of input jacks (on this unit) depending on the audio output jacks available on your video device.

Output jacks on video device		Input jacks on this unit
Video	Audio	
Component video	Digital optical	AV1 (COMPONENT VIDEO + OPTICAL)
	Digital coaxial	AV2 (COMPONENT VIDEO + COAXIAL)

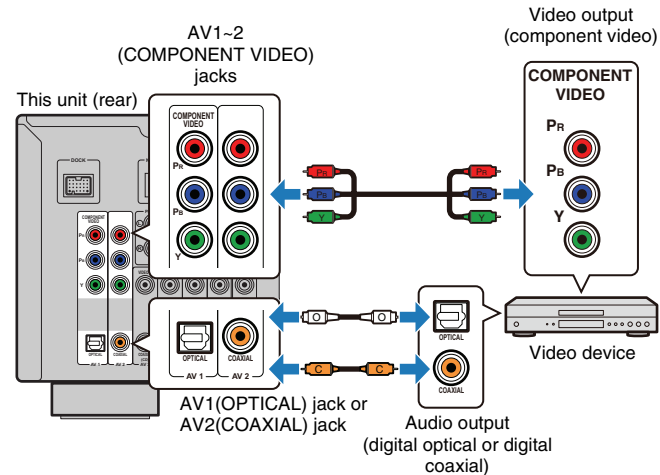

If you select the input source by pressing AV1~2, the video/audio played back on the video device will be output from this unit.

## ■ Composite video connection

Connect a video device to this unit with a video pin cable and an audio cable (digital coaxial, digital optical or stereo pin cable). Choose a set of input jacks (on this unit) depending on the audio output jacks available on your video device.

Output jacks on video device		Input jacks on this unit
Video	Audio	
Composite video	Digital coaxial	AV3 (VIDEO + COAXIAL)
	Digital optical	AV4 (VIDEO + OPTICAL)
	Analog stereo	AV5 (VIDEO + AUDIO)
		AV6 (VIDEO + AUDIO)

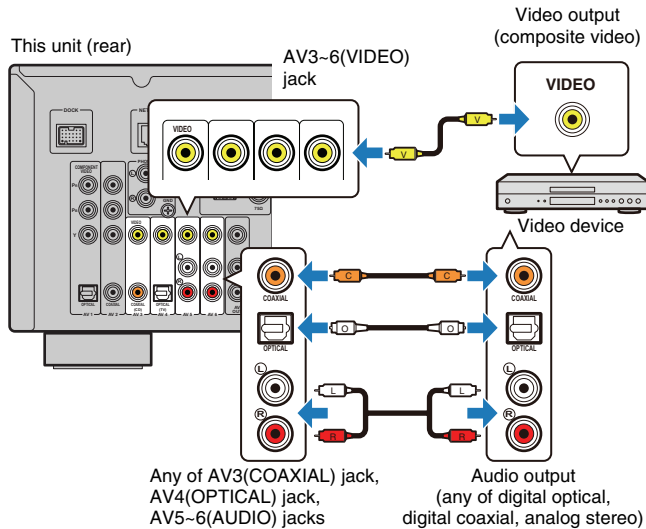

If you select the input source by pressing AV3~6, the video/audio played back on the video device will be output from this unit.

## ■ Changing the combination of video/audio input jacks

If the combination of video/audio input jacks prepared on this unit does not match your video device, change its combination according to the output jacks of your device. It enables you to connect a video device that has the following video/audio output jacks.

Output jacks on video device		Input jacks on this unit	
Video	Audio	Video	Audio
HDMI	Digital optical	HDMI1~7	AV1 (OPTICAL) AV4 (OPTICAL)
	Digital coaxial	HDMI1~7	AV2~3 (COAXIAL)
	Analog stereo	HDMI1~7	AV5~6 (AUDIO) AUDIO 1~2
Component video	Analog stereo	AV1~2 (COMPONENT VIDEO)	AV5~6 (AUDIO) AUDIO1~2

### Necessary setting

For example, if you have connected a video device to AV2 (COMPONENT VIDEO) and AV5 (AUDIO) jacks of this unit, change the combination setting as follows.

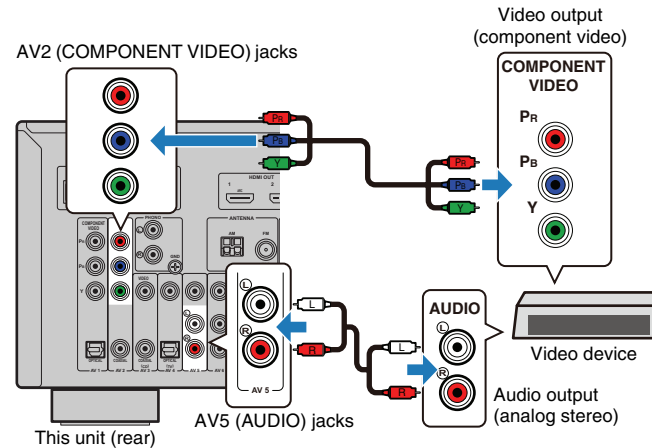

- 1 After connecting external devices (TV, playback devices, etc.) and power cable of this unit, turn on this unit and TV.
- 2 Switch the TV input to display the video from this unit.
- 3 Press ON SCREEN.
- 4 Use the cursor keys to select “Input” and press ENTER.
- 5 Use the cursor keys (◀/▶) to select “AV2” (video input jack to be used) and press the cursor key (△).

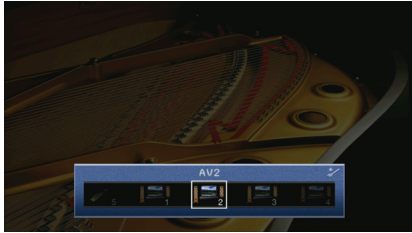

- 6 Use the cursor keys to select “Audio In” and press ENTER.
- 7 Use the cursor keys to select “AV5” (audio input jack to be used).

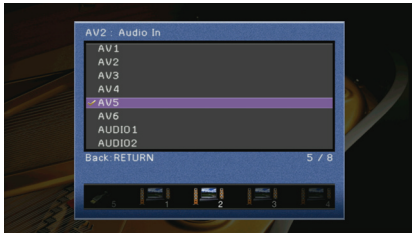

- 8 Press ON SCREEN.

Now the necessary setting is complete.

If you select “AV2” as the input source by pressing AV2, the video/audio played back on the video device will be output from this unit.

## Connecting audio devices (CD players, etc.)

Connect audio devices such as CD players, MD players and a turntable to this unit. Depending on the audio output jacks available on your audio device, choose one of the following connections.

Audio output jacks on audio device	Audio input jacks on this unit
Digital optical	AV1 (OPTICAL) AV4 (OPTICAL)
Digital coaxial	AV2~3 (COAXIAL)
Analog stereo	AV5~6 (AUDIO) AUDIO1~2
Turntable (PHONO)	PHONO

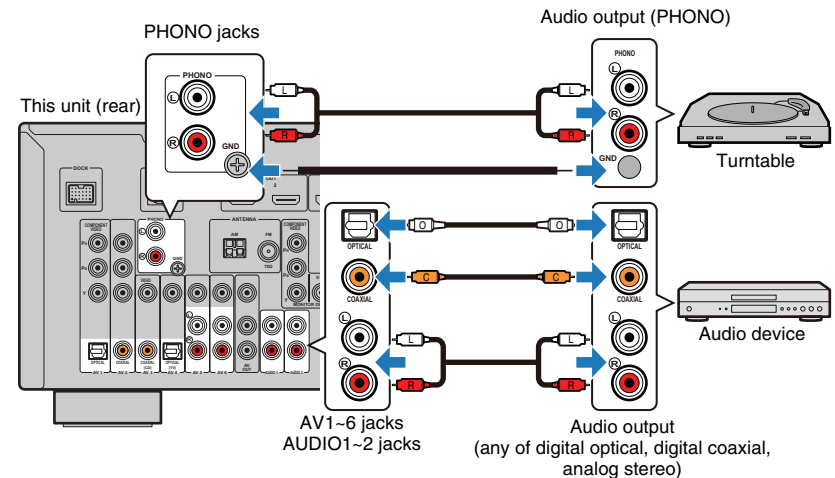

If you select the input source by pressing AV1~6, AUDIO1~2 or PHONO, the audio played back on the audio device will be output from this unit.

## Connecting to the jacks on the front panel

Use the VIDEO AUX jacks on the front panel to temporarily connect devices such as a game console and a camcorder to this unit. Before making a connection, stop playback on the device and turn down the volume of this unit.

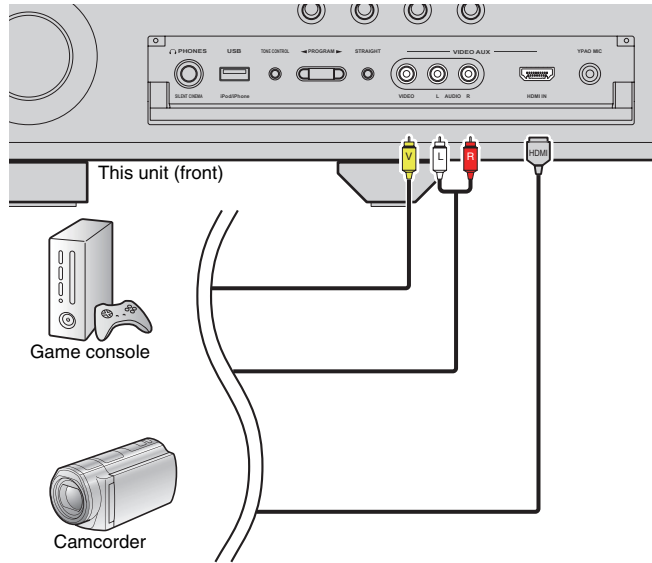

If you select “V-AUX” as the input source by pressing V-AUX, the video/audio played back on the device will be output from this unit.



- If you connect video devices to both the HDMI IN jack and VIDEO/AUDIO jacks, this unit outputs video/audio input through the HDMI IN jack.

## 5 Connecting the FM/AM antennas

Connect the supplied FM/AM antennas to this unit.

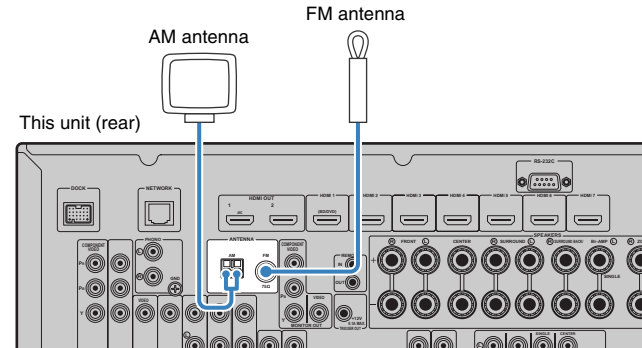

### Assembling and connecting the AM antenna

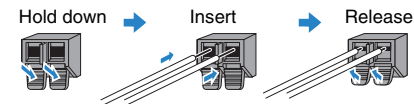
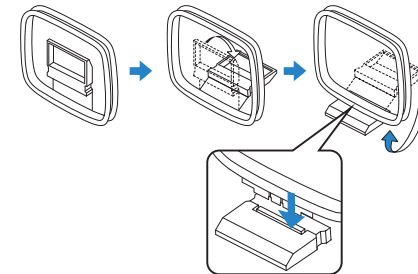

- Unwind the antenna cable from the AM antenna unit only the length needed.
- The wires of the AM antenna have no polarity.

## 6 Connecting to the network

Connect this unit to your router with a commercially-available STP network cable (CAT-5 or higher straight cable).

You can enjoy Internet radio or music files stored on PCs and DLNA servers such as Network Attached Storage (NAS) on this unit.

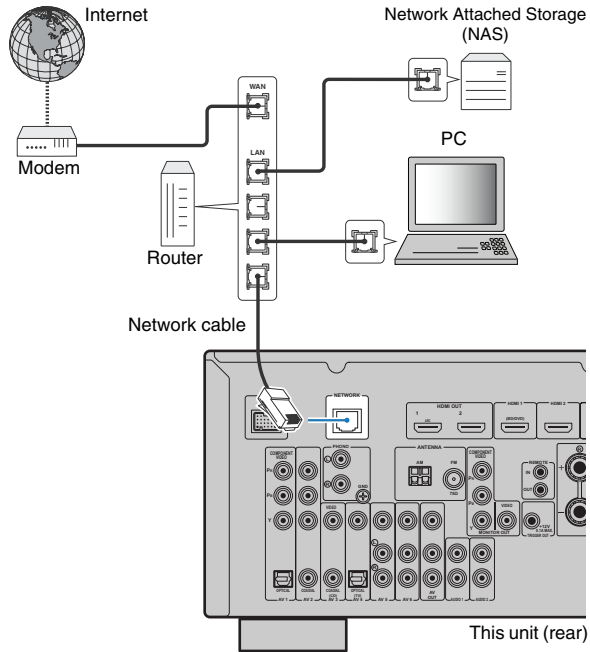

- Some security software installed on your PC or the firewall settings of your network devices (such as a router) may block the access of this unit to the network devices or the Internet. In such cases, configure the security software or firewall settings appropriately.
- You can connect this unit to up to 16 music servers (PC, etc.), and each server must be connected to the same subnet as this unit.
- To use the service via the Internet, broadband connection is strongly recommended.



- When using a router that supports the DHCP function, the network parameters (IP address, etc.) will be automatically assigned to this unit without configuring the network settings of this unit. If your router does not support the DHCP function or you want to configure the network parameters manually, configure the network settings (p.95).
- You can check whether the network parameters (IP address, etc.) are properly assigned to this unit in "Network" (p.100) in the "Information".

## 7 Connecting other devices

### Connecting an external power amplifier

When connecting an external power amplifier (pre-main amplifier) to enhance speaker output, connect the input jacks of the power amplifier to the PRE OUT jacks of this unit. The same channel signals are output from the PRE OUT jacks as from their corresponding SPEAKERS terminals.

This unit (rear)

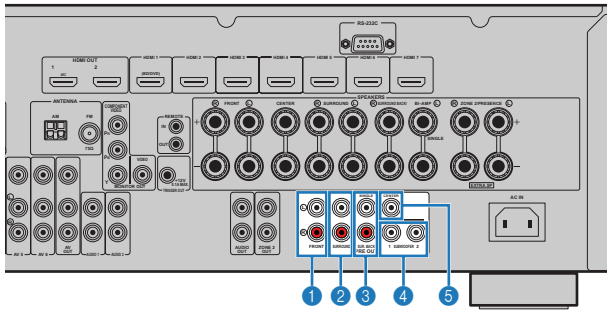

- 1 FRONT jacks**  
Output front channel sounds.
- 2 SURROUND jacks**  
Output surround channel sounds.
- 3 SUR. BACK jacks**  
Output surround back channel sounds. When using only one external amplifier for the surround back channel, connect it to the SINGLE jack (L side).
- 4 SUBWOOFER1~2 jacks**  
For connecting a subwoofer with built-in amplifier. When 2 subwoofers are connected, the same sound is output from them.
- 5 CENTER jack**  
Outputs center channel sounds.

### Connecting video/audio recording devices

You can connect video/audio recording devices to the AV OUT and AUDIO OUT jacks. These jacks output analog video/audio signals selected as the input.



- To copy video/audio from a video device, connect the video device to the AV5-6 jacks or V-AUX (VIDEO/AUDIO) jacks of this unit.
- To copy audio from an audio device, connect the audio device to the AV5-6 jacks, AUDIO1-2 jacks or V-AUX (AUDIO) jacks of this unit.

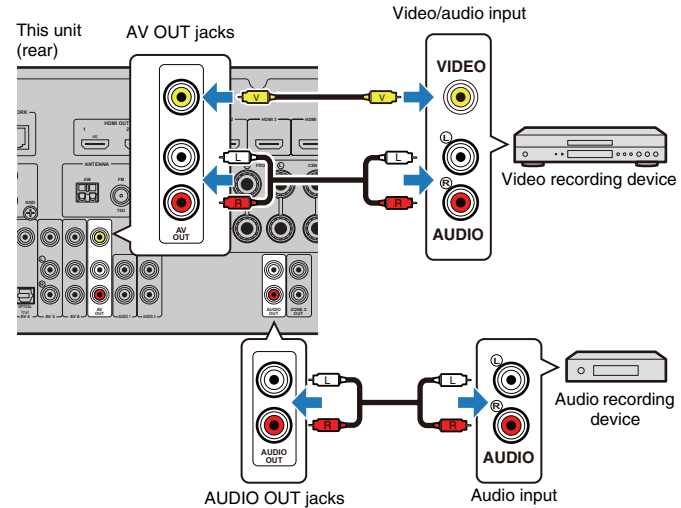

## Connecting a device compatible with SCENE link playback (remote connection)

If you have a Yamaha product that has the capability of the SCENE control signal transmission, you can control the Yamaha product in conjunction with a scene selection (p.43) by connecting it to the REMOTE OUT jack with a monaural mini-jack cable.

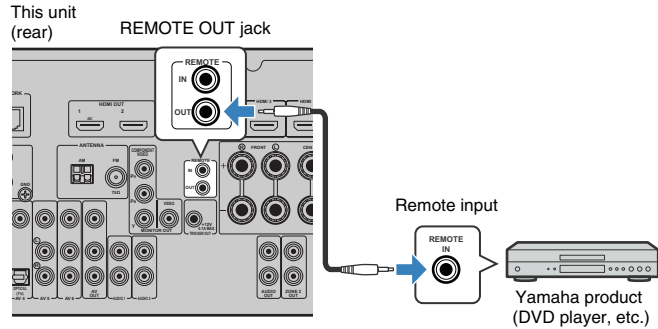

- If you connect a Yamaha product compatible with SCENE link playback to the REMOTE OUT jack, you can start playback on the Yamaha product in conjunction with a scene selection (p.43). To enable the SCENE link playback, specify the device type in "Device Control" (p.82) in the "Scene" menu.
- You also connect an infrared signal receiver/emitter to operate devices in the main zone from Zone2 (p.68).

## Connecting a device compatible with the trigger function

The trigger function can control an external device in conjunction with operations (power-on/off, input selection, etc.) on this unit. If you have a Yamaha subwoofer that supports a system connection or a device with a trigger input jack, you can use the trigger function by connecting the external device to the TRIGGER OUT jack.

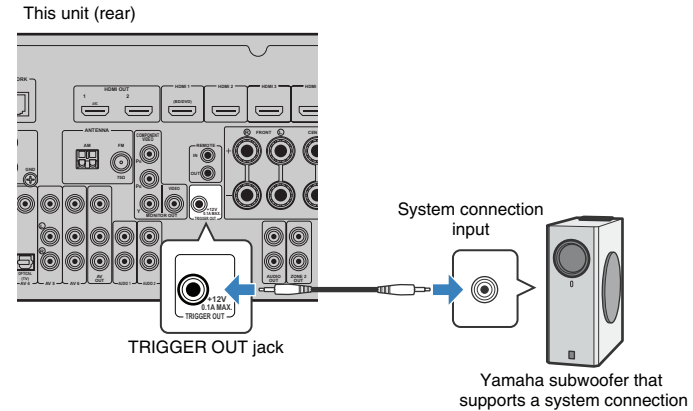

- You can configure the trigger function settings in "Trigger Output" (p.98) in the "Setup" menu.



## 8 Connecting the power cable

### Before connecting the power cable (General model only)

Set the switch position of VOLTAGE SELECTOR according to your local voltage. Voltages are AC 110-120/220-240 V, 50/60 Hz.



- Make sure you set VOLTAGE SELECTOR of the unit BEFORE plugging the power cable into an AC wall outlet. Improper setting of VOLTAGE SELECTOR may cause damage to this unit and create a potential fire hazard.

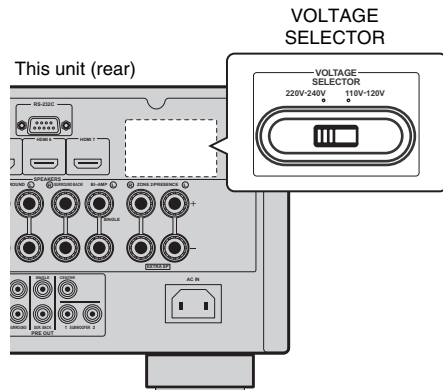

After all the connections are complete, connect the supplied power cable to this unit and then to an AC wall outlet.

This unit (rear)

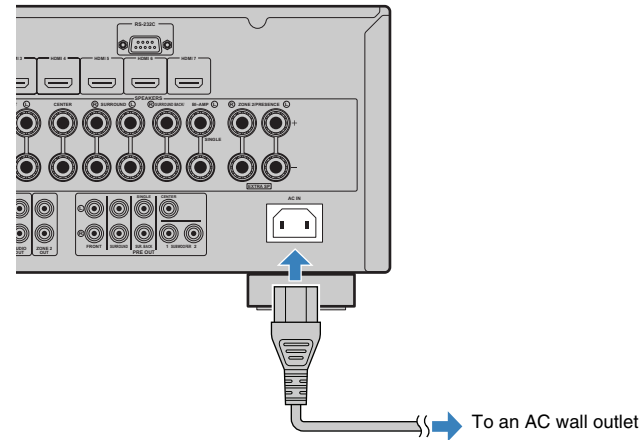

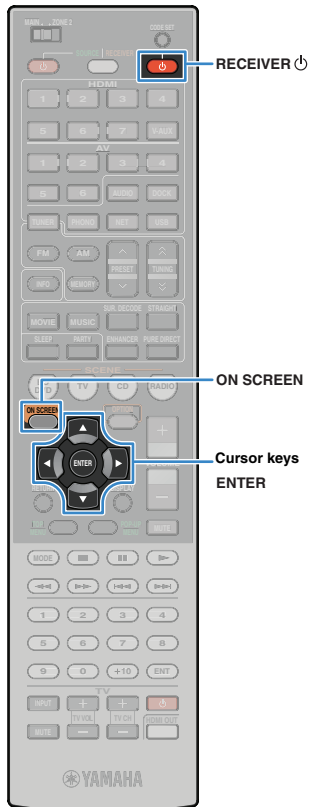

## 9 Selecting an on-screen menu language

Select a desired on-screen menu language from English (default), Japanese, French, German, Spanish and Russian.

- 1 Press RECEIVER to turn on this unit.
- 2 Turn on the TV and switch the TV input to display the video from this unit.
- 3 Press ON SCREEN.
- 4 Use the cursor keys to select “Setup” and press ENTER.

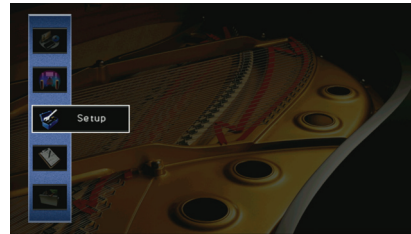

- 5 Use the cursor keys (>) to select “Language” and the cursor keys (>) to select a desired language.



- 6 To exit from the menu, press ON SCREEN.



- The information on the front display is provided in English only.



## 10 Optimizing the speaker settings automatically (YPAO)

By using the Yamaha Parametric room Acoustic Optimizer (YPAO) function, this unit automatically detects speaker connections and distances from the listening position, and optimizes the speaker settings such as volume balance and acoustic parameters to suit your room.



Please note the following when using YPAO.

- Use YPAO after connecting a TV and speakers to this unit.
- During the measuring process, the test tones are output at high volume. Take care that the test tone does not frighten small children. Also, refrain from using this function at night when it may be a nuisance to others.
- During the measuring process, you cannot adjust the volume.
- During the measuring process, keep the room as quiet as possible.
- Do not connect headphones.
- If your subwoofer supports the auto-standby function, disable it.

- 1 Press RECEIVER  to turn on this unit.**
- 2 Turn on the TV and switch the TV input to display the video from this unit.**
- 3 Turned on the subwoofer and set the volume to half. If the cross-over frequency is adjustable, set it to maximum.**

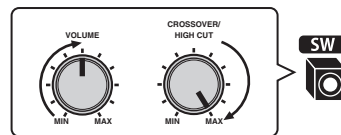

- 4 Place the YPAO microphone at ear height in your listening position and connect it to the YPAO MIC jack on the front panel.**

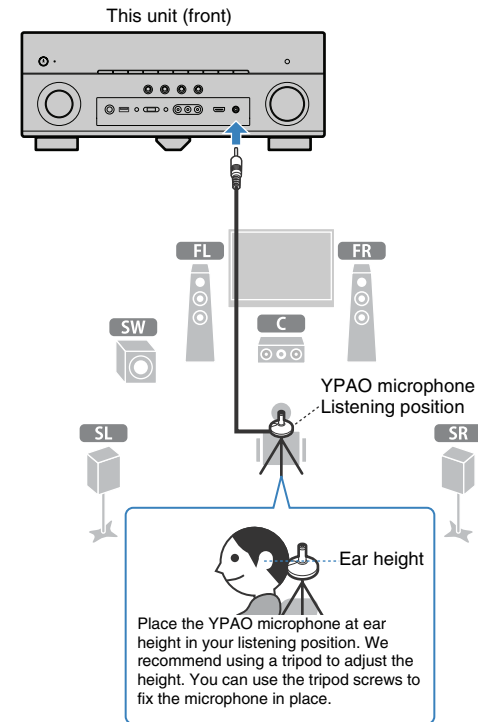



Cursor keys  
ENTER

The following screen appears on the TV.

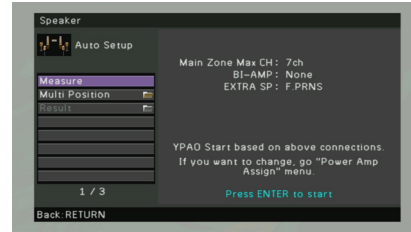

- To cancel the operation, disconnect the YPAO microphone before starting the measurement.

### 5 If desired, change the measuring method (multi/single).

- Use the cursor keys to select "Multi Position" and press ENTER.
- Use the cursor keys to select a setting and then press ENTER.

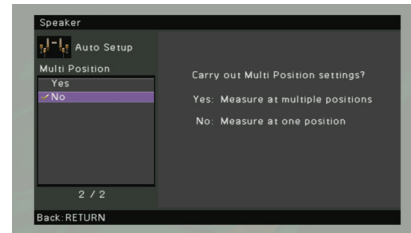

#### Settings

Yes	Select this if your listening position is variable or you will enjoy surround sound with your company. You can perform the measurement at up to 8 positions to optimize the speaker settings to suit all of those positions (multi measure).
No (default)	Select this if your listening position is fixed in one position. You will perform the measurement only once to optimize the speaker settings suit to the position (single measure).



- If you perform the single measure, you will be able to enjoy surround sound at that position with optimized speaker settings. If you perform the multi measure, the speaker settings will be optimized for you to enjoy surround sound in a wider space.

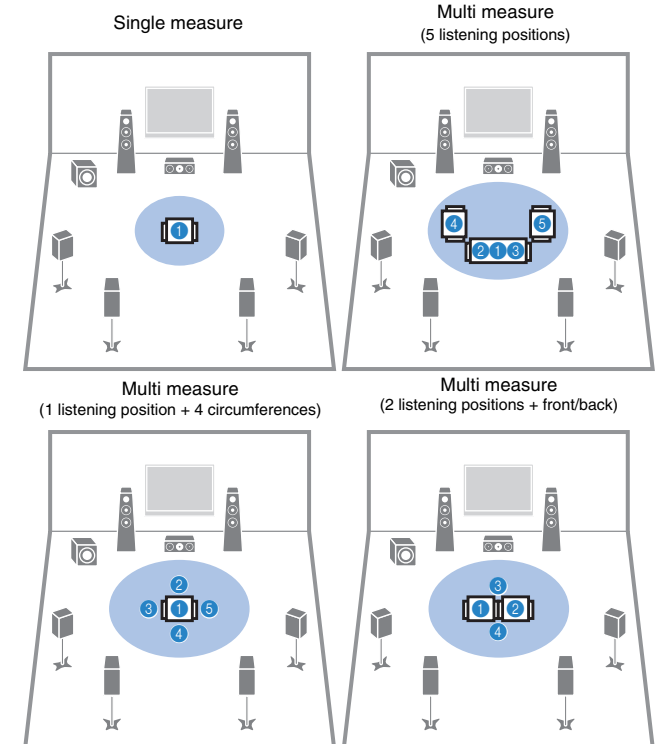

Now all preparations are complete. See the following page to start the measurement.

#### When "Multi Position" is set to "Yes":

"Measuring at multiple listening positions (multi measure)" (p.38)

#### When "Multi Position" is set to "No":

"Measuring at one listening position (single measure)" (p.37)



Cursor keys  
ENTER  
RETURN

## Measuring at one listening position (single measure)

When “Multi Position” is set to “No”, follow the procedure below to make the measurement.



- YPAO measurement is not performed correctly when any obstacles are in the room.
- During the measuring process (about 3 minutes), keep stuff in the corners or remove it from the room.

### 1 To start the measurement, use the cursor keys to select “Measure” and press ENTER.

The measurement will start in 10 seconds. Press ENTER again to start the measurement immediately.



- To cancel the measurement, press RETURN.

The following screen appears on the TV when the measurement finishes.

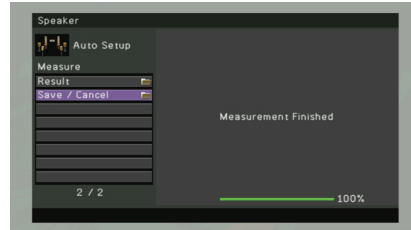

- If any error message (such as E-1) or warning message (such as W-1) appears, see “Error messages” (p.40) or “Warning messages” (p.41).



- To check the measurement results, select “Result”. For details, see “Checking the measurement results” (p.39).

### 2 Use the cursor keys to select “Save/Cancel” and press ENTER.

### 3 To save the measurement results, use the cursor keys to select “SAVE” and press ENTER.



The corrected speaker settings are applied.



- To finish the measurement without saving the result, select “CANCEL”.

### 4 Disconnect the YPAO microphone from this unit.

Now optimization of the speaker settings is complete.

#### Caution

- Since the YPAO microphone is sensitive to heat, do not place the microphone in any place where it will be subjected to direct sunlight or high temperatures (top of an AV equipment, etc).



Cursor keys  
ENTER  
RETURN

## Measuring at multiple listening positions (multi measure)

When "Multi Position" is set to "Yes", follow the procedure below to make the measurement.



- YPAO measurement is not performed correctly when any obstacles are in the room.
- During the measuring process, keep stuff in the corners or remove it from the room. It takes about 10 minutes to make the measurement at 8 listening positions.
- If any error message (such as E-1) or warning message (such as W-1) appears, see "Error messages" (p.40) or "Warning messages" (p.41).

### 1 To start the measurement, use the cursor keys to select "Measure" and press ENTER.

The measurement will start in 10 seconds. Press ENTER again to start the measurement immediately.



- To cancel the measurement, press RETURN.

The following screen appears on the TV when the measurement at the first position finishes.



### 2 Move the YPAO microphone to the next listening position and press ENTER.

Repeat step 2 until the measurement at all listening positions (up to 8) are made.

### 3 If the measurement at all listening position are made, use the cursor keys to select "CANCEL" and press ENTER.

If you have made the measurement at 8 listening positions, the following screen appears automatically.



- To check the measurement results, select "Result". For details, see "Checking the measurement results" (p.39).

### 4 Use the cursor keys to select "Save/Cancel" and press ENTER.

### 5 To save the measurement result, use the cursor keys to select "SAVE" and press ENTER.

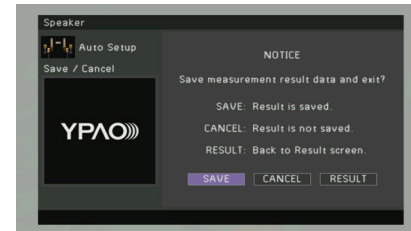

The corrected speaker settings are applied.



- To finish the measurement without saving the result, select "CANCEL".

### 6 Disconnect the YPAO microphone from this unit.

Now optimization of the speaker settings is complete.

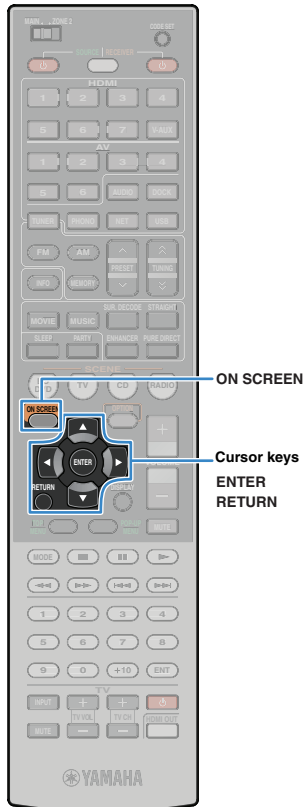

**Caution**

- Since the YPAO microphone is sensitive to heat, do not place the microphone in any place where it will be subjected to direct sunlight or high temperatures (top of an AV equipment, etc).

## Checking the measurement results

You can check the YPAO measurement results.

- After the measurement, use the cursor keys to select “Result” and press ENTER.



- You can also select “Result” from “Auto Setup” (p.87) in the “Setup” menu. In this case, the previous measurement results are displayed.

The following screen appears.

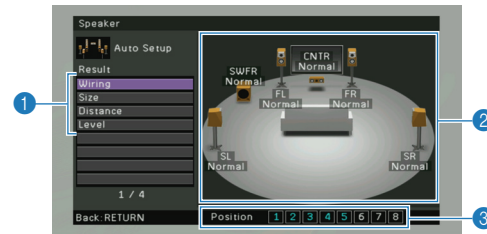

- Measurement result items
- Measurement result details
- The number of measured positions (when multi measure is performed)

- Use the cursor keys to select an item

<b>Wiring</b>	<p>Polarity of each speaker</p> <p><b>Normal:</b> The speaker cable is connected with the correct polarity (+/-).</p> <p><b>Reverse:</b> The speaker cable may be connected with the reversed polarity (+/-).</p>
---------------	---

<b>Size</b>	<p>Size of each speaker (cross-over frequency of the subwoofer)</p> <p><b>Large:</b> The speaker can reproduce low-frequency signals effectively.</p> <p><b>Small:</b> The speaker cannot reproduce low-frequency signals effectively.</p>
<b>Distance</b>	Distance from the listening position to each speaker
<b>Level</b>	Output level adjustment for each speaker



- A speaker with any problem is indicated with a red-boxed message.

- To finish checking the results and return to the previous screen, press RETURN.

## Reloading the previous YPAO adjustments

When the speaker settings you have configured manually are not suitable, follow the procedure below to discard the manual settings and reload the previous YPAO adjustments.

- In the “Setup” menu, select “Speaker”, “Auto Setup” and then “Result” (p.86).
- Use the cursor keys to select “Setup Reload” and press ENTER.

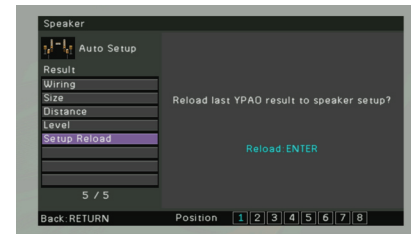

- To exit from the menu, press ON SCREEN.

## Error messages

If any error message is displayed during the measurement, resolve the problem and perform YPAO again.

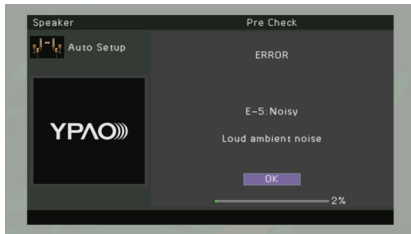

Error message	Cause	Remedy
<b>E-1: No Front SP</b>	Front speakers are not detected.	
<b>E-2: No Sur. SP</b>	Either of surround speakers is not detected.	Follow the on-screen instructions to exit YPAO, turn off this unit, and then check the speaker connections.
<b>E-3: No F.PRNS SP</b>	Either of presence speakers is not detected.	
<b>E-4: SBR→SBL</b>	A surround back speaker is connected to the R side only.	When using only one surround back speaker, you need to connect it to the SINGLE jack (L side). Follow the on-screen instructions to exit YPAO, turn off this unit, and then reconnect the speaker.
<b>E-5: Noisy</b>	The noise is too loud.	Keep the room quiet and follow the on-screen instructions to start the measurement again. If you select "PROCEED", the measurement starts again on the condition this unit ignores the noisy error even if noises are detected.
<b>E-6: Check Sur.</b>	Any surround back speaker is connected while no surround speakers are connected.	Surround speakers should be connected when using surround back speakers. Follow the on-screen instructions to exit YPAO, turn off this unit, and then reconnect the speakers.
<b>E-7: No MIC</b>	The YPAO microphone has been removed.	Connect the YPAO microphone to the YPAO MIC jack firmly and follow the on-screen instructions to start the measurement again.
<b>E-8: No Signal</b>	The YPAO microphone cannot detect test tones.	Connect the YPAO microphone to the YPAO MIC jack firmly and follow the on-screen instructions to start the measurement again. If this error occurs repeatedly, contact the nearest authorized Yamaha dealer or service center.
<b>E-9: User Cancel</b>	The measurement has been canceled.	Follow the on-screen instructions to start the measurement again. To cancel the measurement, select "EXIT".
<b>E-10: Internal Error</b>	An internal error has occurred.	Follow the on-screen instructions to exit YPAO, turn off and on this unit. If this error occurs repeatedly, contact the nearest authorized Yamaha dealer or service center.



## Warning messages

Even if any warning message is displayed after the measurement, you can save the measurement results by following on-screen instructions. However, we recommend you perform YPAO again to use this unit with the optimal speaker settings.



Warning message	Cause	Remedy
<b>W-1: Out of Phase</b>	Any of the speaker cables may be connected with the reversed polarity (+/-).	Select "Wiring" in "Result" (p.39) and check the cable connections (+/-) of the speaker indicated with "Reverse". If the speaker is connected incorrectly, turn off this unit and then reconnect the speaker cable. Depending on the type of speakers or room environment, this message may appear even if the speakers are connected correctly.
<b>W-2: Over Distance</b>	Any of the speakers is placed more than 24 m from the listening position.	Select "Distance" in "Result" (p.39) and move the speaker indicated with ">24.0m (>80.0ft)" within 24 m of the listening position.
<b>W-3: Level Error</b>	There are a significant volume differences between the speakers.	Check the use environment and cable connections (+/-) of each speaker, and the volume of the subwoofer. We recommend using the same speakers or speakers with as similar specifications as possible.

# PLAYBACK

## Basic playback procedure

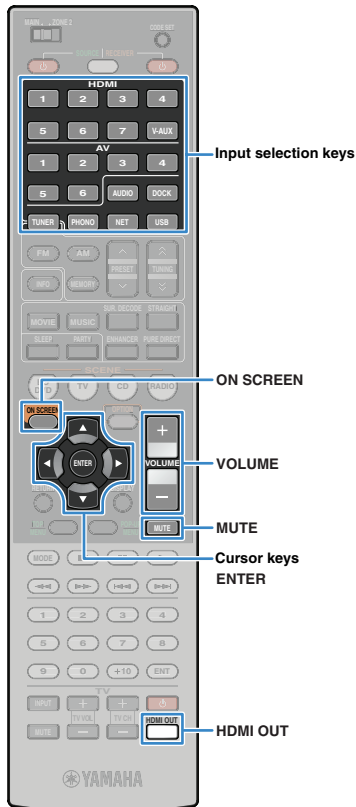

- 1 Turn on external devices (TV, BD/DVD player, etc.) connected to this unit.
- 2 Use the input selection keys to select an input source.
- 3 Start playback on the external device, or select a radio station.  
Refer to the instruction manual of the external device. For details on the following operations, see the corresponding pages.
  - Listening to FM/AM radio (p.49)
  - Playing back iPod music/videos (p.52)
  - Playing back music via Bluetooth (p.57)
  - Playing back music stored on a USB storage device (p.59)
  - Playing back music stored on PCs (p.62)
  - Listening to Internet radio (p.65)

- 4 Press VOLUME to adjust the volume.



- To mute the audio output, press MUTE. Press MUTE again to unmute.
- To adjust treble/bass parts of sound, use the "Option" menu or TONE CONTROL on the front panel (p.76).

## On-screen input selection

- ① Press ON SCREEN.
- ② Use the cursor keys to select "Input" and press ENTER.
- ③ Use the cursor keys to select a desired input source and press ENTER.

## Selecting an HDMI output jack

- 1 Press HDMI OUT to select an HDMI OUT jack.

Each time you press the key, the HDMI OUT jack to be used for signal output switches.



<b>HDMI OUT 1+2</b>	Outputs the same signal at both the HDMI OUT 1 and HDMI OUT 2 jacks.
<b>HDMI OUT 1</b>	Outputs the signals at the selected HDMI OUT jack.
<b>HDMI OUT 2</b>	
<b>HDMI OUT Off</b>	Does not output the signals at the HDMI OUT jacks.



- You can also select an HDMI output jack by selecting a scene (p.43).
- When "HDMI OUT 1+2" is selected, this unit outputs video signals at the highest resolution that both TVs connected to this unit support. (For example, if you have connected a 1080p TV to the HDMI OUT 1 jack, and a 720p TV to the HDMI OUT 2 jack, this unit outputs 720p video signals.)

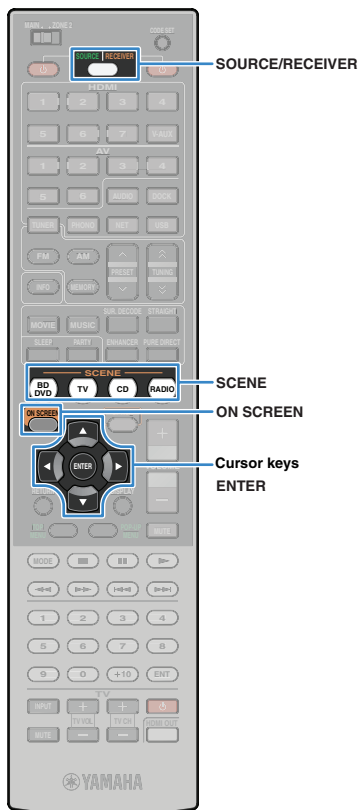

## Selecting the input source and favorite settings at once (SCENE)

The SCENE function allows you to select the assigned input source, sound program, Compressed Music Enhancer on/off, and HDMI output jack at once.

### 1 Press SCENE.

The input source and settings registered to the corresponding scene are selected. This unit turns on automatically when it is in standby mode.

By default, the following settings are registered for each scene.

SCENE	Input	Sound program	Compressed Music Enhancer	HDMI output jack
<b>BD/DVD</b>	HDMI1	MOVIE (Drama)	Off	HDMI OUT 1+2
<b>TV</b>	AV4	STRAIGHT	On	HDMI OUT 1+2
<b>CD</b>	AV3	STRAIGHT	Off	HDMI OUT 1+2
<b>RADIO</b>	TUNER	MUSIC (7ch Stereo)	On	HDMI OUT 1+2



On-screen scene selection

- ① Press ON SCREEN.
- ② Use the cursor keys to select "Scene" and press ENTER.
- ③ Use the cursor keys to select a desired scene and press ENTER.

## Configuring scene assignments

### 1 Perform the following operations to prepare the settings you want to assign to a scene.

- Select an input source (p.42)
- Select a sound program (p.44)
- Enable/disable Compressed Music Enhancer (p.48)
- Select an HDMI output jack (p.42)

### 2 Hold down the desired SCENE key until "SET Complete" appears on the front display.



### 3 If you want to control the corresponding playback device after selecting the scene, hold down the corresponding SCENE key and input selection key together for more than 3 seconds.

Once the setting is completed successfully, SOURCE/RECEIVER blinks twice.



- If you have not registered the remote control code of the playback device yet, see "Setting the remote control codes for playback devices" (p.105) to register it.
- You can also configure scene assignments in the "Scene" menu (p.81).
- You can start playback of external devices connected to this unit via HDMI or a Yamaha product connected to the REMOTE OUT jack, in conjunction with a scene selection (SCENE link playback). To enable the SCENE link playback, specify the device type in "Device Control" (p.82) in the "Scene" menu.

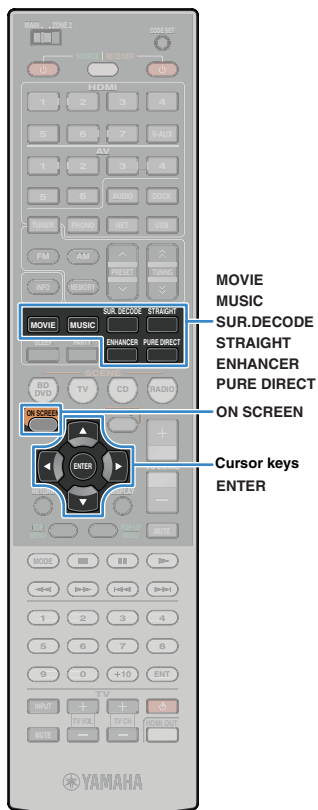

## Selecting the sound mode

This unit is equipped with a variety of sound programs and surround decoders that allow you to enjoy playback sources with a favorite sound mode (sound field effect, stereo playback, etc).

### Selecting a sound program suitable for movies (p.45)

Press MOVIE repeatedly.

### Selecting a sound program suitable for music or stereo playback (p.46)

Press MUSIC repeatedly.

### Selecting a surround decoder (p.47)

Press SUR.DECODE repeatedly.

### Switching to the straight decode mode (p.47)

Press STRAIGHT.

### Switching to the Pure Direct mode (p.48)

Press PURE DIRECT.

### Enable Compressed Music Enhancer (p.48)

Press ENHANCER.



### On-screen sound program/surround decoder selection

- ① Press ON SCREEN.
- ② Use the cursor keys to select "Sound Program" and press ENTER.
- ③ Use the cursor keys to select a sound program/surround decoder and press ENTER.



- You can change the settings of the surround programs and surround decoders in the "Sound Program" menu (p.83).
- The sound mode can be applied separately to each input source.
- When you play back audio signals with sampling frequency of higher than 96 kHz or DTS Express sources, the straight decode mode (p.47) is automatically selected.
- You can check which speakers are currently outputting sound with the speaker indicators on the front panel (p.9) or the "Audio Signal" screen in the "Information" menu (p.99).

## Enjoying sound field effects (CINEMA DSP)

### CINEMA DSP

This unit is equipped with a variety of sound programs that utilize Yamaha's original DSP technology (CINEMA DSP). It allows you to easily create sound fields like actual movie theaters or concert halls in your room.

Sound program category

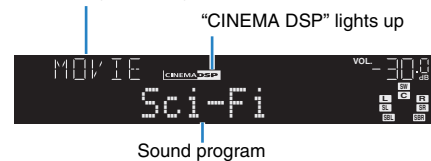

- When you play back DTS-HD sources, the DTS decoder is automatically selected.

### Sound programs suitable for movies (MOVIE)

The following sound programs are optimized for viewing video sources such as movies, TV programs and games.

#### MOVIE THEATER

<b>Standard</b>	This program creates a sound field emphasizing the surround feeling without disturbing the original acoustic positioning of multi-channel audio such as Dolby Digital and DTS. It has been designed with the concept of an ideal movie theater, in which the audience is surrounded by beautiful reverberations from the left, right and rear.
<b>Spectacle</b>	This program represents the spectacular feeling of large-scale movie productions. It reproduces a broad theater sound field that matches cinemascope and wider-screen movies with an excellent dynamic range providing everything from very small sound effects to large, impressive sounds.
<b>Sci-Fi</b>	This program clearly reproduces the finely elaborated sound design of the latest science fiction and special effects-featuring movies. You can enjoy a variety of cinematographically created virtual spaces reproduced with clear separation between dialog, sound effects and background music.
<b>Adventure</b>	This program is ideal for precisely reproducing the sound design of action and adventure movies. The sound field restrains reverberations but puts emphasis on reproducing a powerful space expanded widely to the left and right. The reproduced depth is also restrained relatively to ensure the separation between audio channels and the clarity of the sound.

<b>Drama</b>	This program features stable reverberations that match a wide range of movie genres from serious dramas to musicals and comedies. The reverberations are modest but offer an optimum 3D feeling, reproducing effects tones and background music softly but cubically around clear words and center positioning in a way that does not fatigue the listener even after long hours of viewing.
<b>Mono Movie</b>	This program is provided for reproducing monaural video sources such as a classic movie in an atmosphere of a good old movie theater. The program produces the optimum expansion and reverberation to the original audio to create a comfortable space with a certain sound depth.

#### ENTERTAINMENT

<b>Sports</b>	This program allows the listeners to enjoy stereo sport broadcasts and studio variety programs with enriched live feeling. In sports broadcasts, the voices of the commentator and sportscaster are positioned clearly at the center while the atmosphere of the stadium expands in an optimal space to offer the listeners a feeling of presence in the stadium.
<b>Action Game</b>	This program is suitable for action games such as car racing, fighting games and FPS games. The reality of, and emphasis on, various effects makes the player feel like they are right in the middle of the action, allowing for greater concentration. Use this program in combination with Compressed Music Enhancer for a more dynamic and strong sound field.
<b>Roleplaying Game</b>	This program is suitable for role-playing and adventure games. This program adds depth to the sound field for natural and realistic reproduction of background music, special effects and dialog from a wide variety of scenes. Use this program in combination with Compressed Music Enhancer for a more clear and spatial sound field.
<b>Music Video</b>	This program offers an image of a concert hall for live performance of pop, rock and jazz music. The listener can indulge oneself in a hot live space thanks to the presence sound field that emphasizes the vividness of vocals and solo play and the beat of rhythm instruments, and to the surround sound field that reproduces the space of a big live hall.

## ■ Sound programs suitable for music/stereo playback (MUSIC)

The following sound programs are optimized for listening to music sources such as music CDs.

You can also select stereo playback.

### □ CLASSICAL

<b>Hall in Munich</b>	This program simulates a concert hall with approximately 2500 seats in Munich, using stylish wood for the interior finishing as normal standards for European concert halls. Fine, beautiful reverberations spread richly, creating a calming atmosphere. The listener's virtual seat is at the center left of the arena.
<b>Hall in Vienna</b>	This program simulates an approximately 1700-seat, middle-sized concert hall with a shoebox shape that is traditional in Vienna. Pillars and ornate carvings create extremely complex reflections from all around the audience, producing a very full, rich sound.
<b>Chamber</b>	This program creates a relatively wide space with a high ceiling like an audience hall in a palace. It offers pleasant reverberations that are suitable for courtly music and chamber music.

### □ LIVE/CLUB

<b>Cellar Club</b>	This program simulates a live house with a low ceiling and homey atmosphere. A realistic, live sound field features powerful sound as if the listener is in a row in front of a small stage.
<b>The Roxy Theatre</b>	This program creates the sound field of a rock music live house in Los Angeles, with approximately 460 seats. The listener's virtual seat is at the center left of the hall.
<b>The Bottom Line</b>	This program creates the sound field at stage front in The Bottom Line, a famous New York jazz club once. The floor can seat 300 people to the left and right in a sound field offering real and vibrant sound.

### □ STEREO

<b>2ch Stereo</b>	Use this program to mix down multi-channel sources to 2 channels. When multi-channel signals are input, they are down mixed to 2 channels and output from the front speakers (this program does not utilize CINEMA DSP).
<b>7ch Stereo</b>	Use this program to output sound from all speakers. When you playback multi-channel sources, this unit down-mixes the source to 2 channels, and then outputs the sound from all speakers. This program creates a larger sound field and is ideal for background music at parties, etc.



SUR.DECODE STRAIGHT

## ■ Enjoying stereoscopic sound fields (CINEMA DSP 3D)



CINEMA DSP 3D enables to create a natural stereoscopic sound field in your room.

CINEMA DSP 3D functions when both of the following conditions are met.

- One of the sound programs (except 2ch Stereo and 7ch Stereo) is selected (p.45).
- "CINEMA DSP 3D Mode" (p.76) in the "Option" menu is set to "On" (default).

"CINEMA DSP 3D" lights up



- We recommend using presence speakers to have a full effect of the stereoscopic sound fields. However, this unit creates Virtual Presence Speaker (VPS) using the front, center and surround speakers to produce stereoscopic sound fields even when no presence speakers are connected.

## ■ Enjoying sound field effects without surround speakers (Virtual CINEMA DSP)

If you select one of the sound programs (except 2ch Stereo and 7ch Stereo) when no surround speakers are connected, this unit automatically creates the surround sound field using the front-side speakers.

## Enjoying unprocessed playback

You can play back input sources without any sound field effect processing.

### ■ Enjoying unprocessed sounds in original channels (straight decode)

When the straight decode mode is enabled, each speaker produces each channel audio signal directly (without sound field processing). When you play back 2-channel sources such as CD, stereo sound is heard from the front speakers. When you play back multi-channel sources, this unit produces unprocessed multi-channel sounds.

#### 1 Press STRAIGHT.

Each time you press the key, the straight decode mode is enabled or disabled.



### ■ Enjoying unprocessed multi-channel sounds (surround decoder)

The surround decoder enables unprocessed multi-channel playback from 2-channel sources. When a multi-channel source is input, it works the same way as the straight decode mode. For details on each decoder see "Glossary" (p.117).

#### 1 Press SUR.DECODE to select a surround decoder.

Each time you press the key, the surround decoder switches.



- |   |   |
|---|---|
| <input checked="" type="checkbox"/> Pro Logic   | Uses the Dolby Pro Logic decoder suitable for any sources.                                |
| <input checked="" type="checkbox"/> PLIIx Movie | Uses the Dolby Pro Logic IIx decoder (or Dolby Pro Logic II decoder) suitable for movies. |
| <input checked="" type="checkbox"/> PLII Movie  |   |

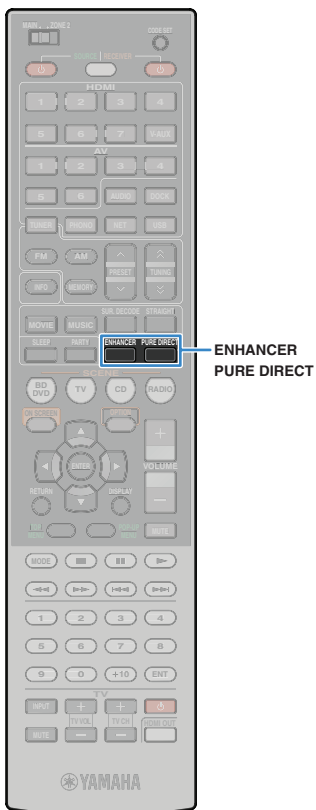

<b>PLIIx Music</b>	Uses the Dolby Pro Logic IIx decoder (or Dolby Pro Logic II decoder) suitable for music.
<b>PLII Music</b>	Uses the Dolby Pro Logic II decoder suitable for music.
<b>PLIIx Game</b>	Uses the Dolby Pro Logic IIx decoder (or Dolby Pro Logic II decoder) suitable for games.
<b>PLII Game</b>	Uses the Dolby Pro Logic II decoder suitable for games.
<b>Neo: 6 Cinema</b>	Uses the DTS Neo: 6 decoder suitable for movies.
<b>Neo: 6 Music</b>	Uses the DTS Neo: 6 decoder suitable for music.



- You cannot select the Dolby Pro Logic IIx decoders when headphones are connected or when "Surround Back" in the "Setup" menu is set to "None".

## Enjoying pure high fidelity sound (Pure Direct)

When the Pure Direct mode is enabled, this unit plays back the selected source with the least circuitry to reduce the electrical noise from other circuitry (front display, etc). It allows you to enjoy Hi-Fi sound quality.

### 1 Press PURE DIRECT.

Each time you press the key, the Pure Direct mode is enabled or disabled.



- When the Pure Direct mode is enabled, the following functions are not available.
  - Selecting sound programs
  - Adjusting the tone control
  - Operating the on-screen menu
  - Viewing information on the front display (when not operated)

## Enjoying compressed music with enhanced sound (Compressed Music Enhancer)

### compressed music ENHANCER

Compressed Music Enhancer improves the sound enhancer near to the original depth and width of compressed music sources. This function can be used along with any other sound modes.

### 1 Press ENHANCER.

Each time you press the key, Compressed Music Enhancer is enabled or disabled.

"ENHANCER" lights up



- Compressed Music Enhancer does not work on the following audio sources.
  - Signals of which sampling rate is over 48kHz
  - High-definition streaming audio



- You can also use "Enhancer" (p.77) in the "Option" menu to enable/disable Compressed Music Enhancer.

## Enjoying surround sound with headphones (SILENT CINEMA)



You can enjoy surround or sound field effects like a multi-channel speaker system with stereo headphones by connecting the headphones to the PHONES jack and selecting a sound program or a surround decoder.



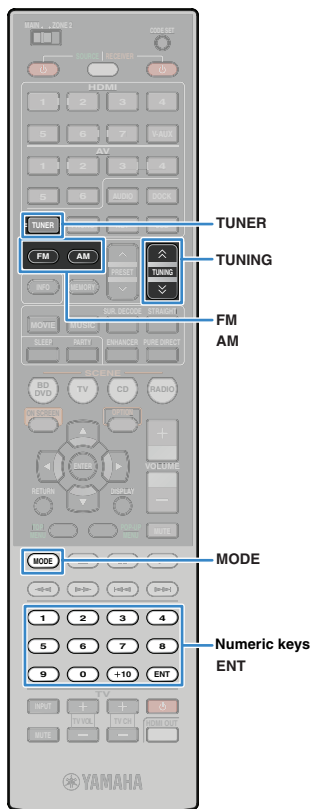

## Listening to FM/AM radio

You can tune into a radio station by specifying its frequency or selecting from registered radio stations.



- The radio frequencies differ depending on the country or region where the unit is being used. The explanation of this section uses a display with frequencies used in Australia model.
- If you cannot have a good reception on the radio, adjust the direction of the FM/AM antennas.

## Setting the frequency steps

(Asia and General models only)

At the factory, the frequency step setting is set to 50 kHz for FM and 9 kHz for AM. Depending on your listening environment, set the frequency steps to 100 kHz for FM and 10 kHz for AM.

- 1 Set this unit to standby mode.
- 2 When holding down STARIGHT on the front panel, press MAIN ZONE .

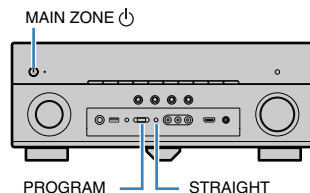

- 3 Press PROGRAM repeatedly to select "TU".



- 4 Press STRAIGHT to select "FM100/AM10".
- 5 Press MAIN ZONE  to set this unit to standby mode and turn it on again.

## Selecting a frequency for reception

- 1 Press TUNER to select "TUNER" as the input source.

- 2 Press FM or AM to select a band.



- 3 Use the following keys to set a frequency.

**TUNING:** Increase/decrease the frequency.

Hold down the key for about a second to search the station automatically.

**Numeric keys:** Enter a frequency directly. For example, to select 98.50 MHz, press "9", "8", "5" and "0" (or ENT).

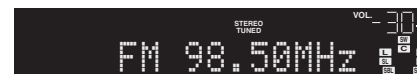

"TUNED" lights up when a signal is received from a radio station.

"STEREO" also lights up when a stereo signal is received.



- "Wrong Station!" appears when you enter a frequency that is out of receivable range



- You can switch between stereo and monaural for FM radio reception by pressing MODE. When signal reception for FM radio station is unstable, switching to monaural may improve it.

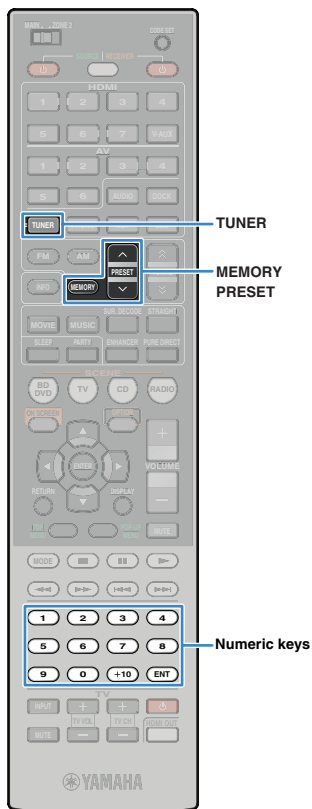

## Registering favorite radio stations (preset)

You can register up to 40 radio stations as presets. Once you registered stations, you can easily tune into those stations by selecting the preset number.



- You can automatically register FM radio stations with strong signals using "Auto Preset" (p.51).

### ■ Registering a radio station

Select a radio station manually and register it to a preset number.

**1** Follow "Selecting a frequency for reception" (p.49) to tune into a desired radio station.

**2** Hold down MEMORY for more than 2 seconds.

The radio station will be registered to the preset number "01" for the first time. After that, it will be registered to an empty preset number (next to the lastly-registered preset number).

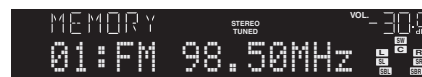

Preset number



- To select a preset number to which the station will be registered, press MEMORY once after tuning into a desired radio station, use PRESET or numeric keys to select a preset number, and then press MEMORY again.

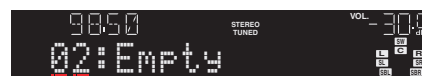

"Empty" (not in use) or frequency currently registered

### ■ Selecting a preset station

Tune into a registered radio station by selecting the preset number.

**1** Press TUNER to select "TUNER" as the input source.

**2** Press PRESET repeatedly to select a desired radio station.

You can also enter a preset number (01 to 40) directly by using the numeric keys after pressing PRESET once.



- "No Presets" appears when no radio stations are registered.
- "Wrong Num." appears when an invalid number is entered.
- "Empty" appears when a preset number not in use is entered.



- To clear preset stations, use "Clear Preset" or "Clear All Preset" (p.51).



TUNER

Menu operation keys  
Cursor keys  
ENTER  
RETURN

## Operating the radio on the TV

You can view the radio information or select a radio station on the TV.

- 1 Press **TUNER** to select “TUNER” as the input source.

The playback screen is displayed on the TV.

## Playback screen

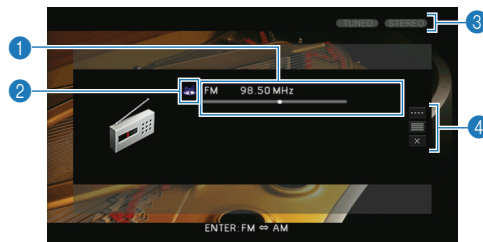

- 1 **Radio station information**  
Displays the information of the selected radio station such as the selected band (FM/AM) and frequency.
- 2 **Band icon**  
Select this icon and press ENTER to switch between FM and AM.
- 3 **TUNED/STEREO indicators**  
“TUNED” lights up when a signal is received from a radio station.  
“STEREO” lights up when a stereo signal is received.
- 4 **Operation menu**  
Use the cursor keys to select an item and press ENTER to confirm the selection.  
To close the submenu, press RETURN.

Menu	Submenu	Function
<b>Manual Tuning</b>	Tuning (+/-)	Selects a frequency.
	Auto (+/-)	Selects a radio station automatically.
	Memory	Registers the selected station as presets.
	Direct	Enters a frequency directly.
<b>Browse</b>		Moves to the browse screen (preset station list).
<b>Screen Off</b>		Closes the screen display and shows the background. Press one of the menu operation keys to redisplay it.

## Browse screen

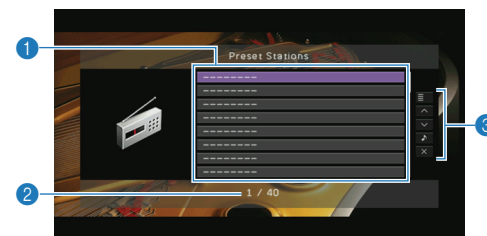

- 1 **Preset station list**  
Displays the list of preset stations. Use the cursor keys to select a preset station and press ENTER to tune into it.
- 2 **Preset number**
- 3 **Operation menu**  
Use the cursor keys to select an item and press ENTER to confirm the selection.  
To close the submenu, press RETURN.

Menu	Submenu	Function
<b>Utility</b>	Memory	Registers the current station to the preset number selected in the list.
	Auto Preset	Automatically registers FM radio stations with strong signals (up to 40 stations).
	Clear Preset	Clear the preset station selected in the list.
	Clear All Preset	Clear all the preset stations.
<b>1 Page Up</b>		Moves to the previous/next page of the list.
<b>1 Page Down</b>		Moves to the playback screen.
<b>Now Playing</b>		Moves to the playback screen.
<b>Screen Off</b>		Closes the screen display and shows the background. Press one of the menu operation keys to redisplay it.

## Playing back iPod music/videos

You can play back iPod music/videos on this unit using a USB cable supplied with iPod, an optional Yamaha iPod dock (such as YDS-12) or an optional Yamaha iPod wireless system (YID-W10).



- This manual describes both the “iPod” and “iPhone” as the “iPod”. “iPod” means both “iPod” and “iPhone” unless the explanation describes exceptions.
- Some features may not be compatible depending on the model or software version of an iPod, or the model of an iPod dock.

### Functional differences depending on the way of connection

	USB cable supplied with iPod	Yamaha iPod universal dock (such as YDS-12)	Yamaha iPod wireless system (YID-W10)
Audio output	✓	✓	✓
Video output	✓*	✓	—
Operation with remote control of the unit	✓	✓	—
Operation with iPod	✓	✓	✓
Operation on TV screen	✓	✓	—
Charging	✓	✓	✓
Charging during standby mode	—	✓	✓
<b>Supported iPod</b>	iPod touch iPod nano (2 gen. to 6 gen.) iPod classic iPhone 4 iPhone 3GS iPhone 3G iPhone	iPod touch iPod nano iPod classic iPod with video iPod with color display iPod with click wheel iPod mini iPhone 4 iPhone 3GS iPhone 3G iPhone	iPod touch iPod nano iPod classic iPod with video iPhone 4 iPhone 3GS iPhone 3G iPhone

\* Requires an Apple Composite AV Cable (not supplied). Connect the USB and composite video plugs of the Apple Composite AV cable to the USB jack and VIDEO AUX (VIDEO) jack of this unit and set “Video Out (USB)” (p.80) in the “Input” menu to “V-AUX”.

## Connecting an iPod

### Using a USB cable

Connect your iPod to this unit with the USB cable supplied with the iPod.

#### 1 Connect the USB cable to the iPod.

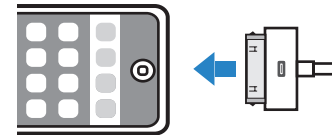

#### 2 Connect the USB cable to the USB jack.

This unit (front)

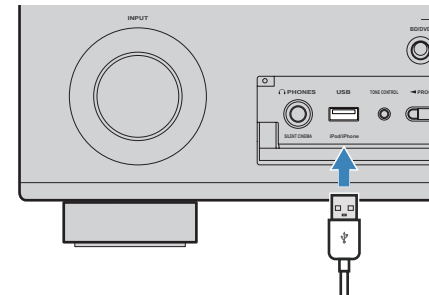

## ■ Using an iPod dock

Refer to the instruction manual of the iPod dock in addition.

- 1 When this unit is in standby mode, connect the iPod dock to the DOCK jack.**

Locate the iPod dock at the distance as far as from this unit.

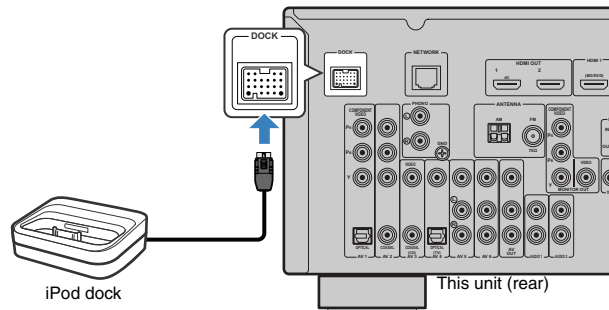

- 2 Connect your iPod to the iPod dock and turn on this unit.**



- While an iPod is connected to the iPod dock, the iPod is charged. You can select whether to charge the iPod when this unit is in standby mode using "Standby Charge" (p.79) in the "Input" menu.

## ■ Using an iPod wireless system

When using an iPod wireless system, operate your iPod itself to start playback after making a connection. Refer to the instruction manual of the iPod wireless system in addition.

- 1 When the power cable is removed from an AC wall outlet, connect the iPod wireless system (receiver) to the DOCK jack.**

Locate the iPod wireless system (receiver) at the distance as far as from this unit.

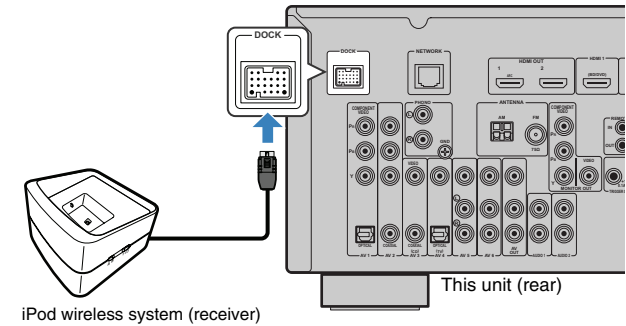

- 2 Connect the power cable to an AC wall outlet.**
- 3 Connect your iPod to the iPod wireless system (transmitter).**
- 4 On your iPod, select the content and start playback.**

This unit automatically turns on and selects "DOCK" as the input source.



- You can select whether to control this unit (power on/off, input selection and volume adjustment) in conjunction with iPod operations using "iPod Interlock" (p.80) in the "Input" menu. When the iPod interlock function is disabled, turn on this unit and select the input source manually.
- While the iPod wireless system (transmitter) is placed on the iPod wireless system (receiver), the iPod is charged. You can select whether to charge the iPod when this unit is in standby mode using "Standby Charge" (p.79) in the "Input" menu.

### Caution

- When you use iPod controls to adjust volume, the volume may be unexpectedly loud. This could result in damage to this unit or speakers. If the volume suddenly increases during playback, remove the iPod from the iPod wireless system (transmitter) immediately. To prevent this problem, we recommend using "Max Volume" (p.92) in the "Setup" menu to set the maximum volume level for this unit.



DOCK  
USB

Menu operation keys  
Cursor keys  
ENTER  
RETURN

## Playback of iPod contents

When using a USB cable or an iPod dock, you can control the iPod with the menu displayed on the TV.



- When using an iPod wireless system, you cannot control the iPod from the TV screen. Operate your iPod itself to select the content and start playback.

- When using a USB cable: press USB to select “USB” as the input source.  
When using an iPod dock: press DOCK to select “DOCK” as the input source.

The browse screen is displayed on the TV.



\* Display example (when using an iPod dock)

- Use the cursor keys to select an item and press ENTER.

If a song is selected, playback starts and the playback screen is displayed.

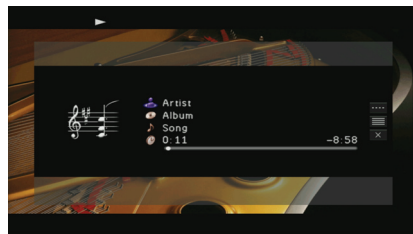

- To return to the previous screen, press RETURN.
- To operate the iPod itself to select a content or control playback, switch to the simple play mode (p.55).

## Browse screen



- Status indicators**  
Display the current shuffle/repeat settings (p.56) and playback status (play/pause, etc).
- List name**
- Contents list**  
Displays the list of iPod contents. Use the cursor keys to select an item and press ENTER to confirm the selection.
- Item number/total**
- Operation menu**  
Use the cursor keys to select an item and press ENTER to confirm the selection.

Menu	Function
<b>1 Page Up</b>	Moves to the previous/next page of the list.
<b>1 Page Down</b>	
<b>10 Pages Up</b>	Moves to 10 pages forward/backward.
<b>10 Pages Down</b>	
<b>Return</b>	Returns to the higher-level list.
<b>Now Playing</b>	Moves to the playback screen.
<b>Screen Off</b>	Closes the screen display and shows the background. Press one of the menu operation keys to redisplay it.



## ■ Playback screen

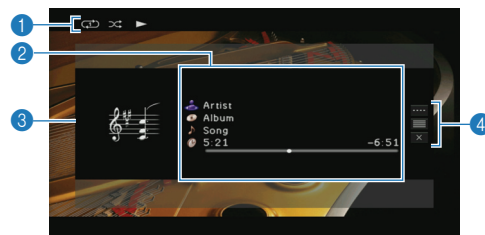

### 1 Status indicators

Display the current shuffle/repeat settings (p.56) and playback status (play/pause, etc).

### 2 Playback information

Displays the artist name, album name, song title and elapsed/remaining time.  
Use the cursor keys to select information to be scrolled.

### 3 Album image

### 4 Operation menu

Use the cursor keys to select an item and press ENTER to confirm the selection.  
To close the submenu, press RETURN.

Menu	Submenu	Function
		Resumes playback from pause.
		Stops playback.
		Stops playback temporarily.
Play Control		Skips forward/backward.
		Searches forward/backward (by holding down).
Browse		Moves to the browse screen.
Screen Off		Closes the screen display and shows the background. Press one of the menu operation keys to redisplay it.



- You can also use the external device operation keys on the remote control to control playback.

## ■ Operating the iPod itself or remote control (simple play)

### 1 Press MODE to switch to the simple play mode.

The TV menu screen turns off and iPod operations are enabled.

To display the TV menu screen, press MODE again.

### 2 Operate your iPod itself or the remote control to start playback.

Operational remote control keys	Function	
Cursor keys	Select an item.	
ENTER	Confirms the selection.	
RETURN	Returns to the previous screen.	
	Starts playback or stops playback temporarily.	
	Stops playback.	
External device operation keys		Skips forward/backward.
		Searches forward/backward (while holding down).

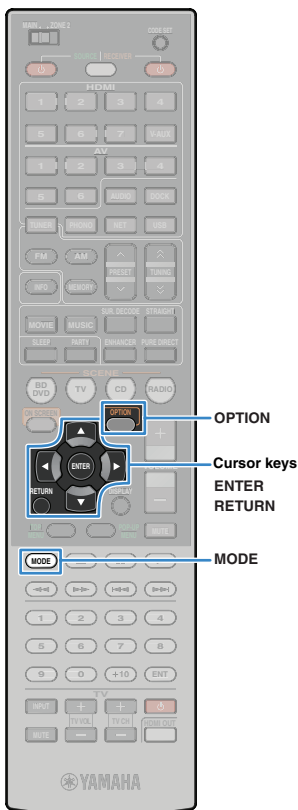

## ■ Shuffle/repeat settings

You can configure the shuffle/repeat settings of your iPod.



- When using an iPod wireless system, configure the shuffle/repeat settings directly on your iPod.
- During simple play, configure the shuffle/repeat settings directly on your iPod, or press MODE to display the TV menu screen and then follow the procedure below.
- Texts in parentheses denote indications on the front display.





**1** When “USB” or “DOCK” is selected as the input source, press **OPTION**.

**2** Use the cursor keys to select “Shuffle” (Shuffle) or “Repeat” (Repeat) and press **ENTER**.



- To return to the previous screen during menu operations, press RETURN.
- Texts in parentheses denote indications on the front display.

**3** Use the cursor keys (</>) to select a setting and press **ENTER**.

Item	Setting	Function
<b>Shuffle (Shuffle)</b>	Off (Off)	Turns off the shuffle function.
	Songs (Songs)	Plays back songs in random order. “  ” appears in the TV screen.
	Albums (Albums)	Plays back albums in random order. “  ” appears in the TV screen.
<b>Repeat (Repeat)</b>	Off (Off)	Turns off the repeat function.
	One (One)	Plays back the current song repeatedly. “  ” appears in the TV screen.
	All (All)	Plays back all songs repeatedly. “  ” appears in the TV screen.

**4** To exit from the menu, press **OPTION**.



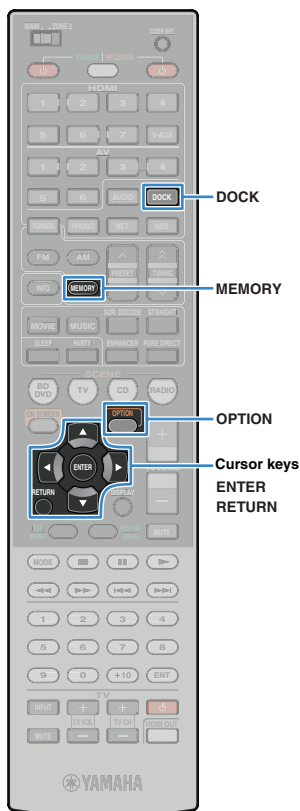

## Playing back music via Bluetooth

You can play back music stored on a Bluetooth component on this unit using a Yamaha Bluetooth wireless audio receiver (such as YBA-10, optional). Refer to the instruction manuals of the Bluetooth receiver and your Bluetooth component in addition. This unit supports A2DP (Advanced Audio Distribution Profile) of the Bluetooth profile.



- When connecting your Bluetooth component to the Bluetooth receiver for the first time, you need to perform “pairing” (mutual recognition for 2 Bluetooth components). After that, you only need to establish a wireless connection between those components to play back music via Bluetooth. “Pairing” must be performed between each combination. So if you have several Bluetooth components, you need to pair each of your Bluetooth components with the Bluetooth receiver.

## Connecting a Bluetooth receiver

- 1 When this unit is in standby mode, connect the Bluetooth receiver to the DOCK jack.

Locate the Bluetooth receiver at the distance as far as from this unit.

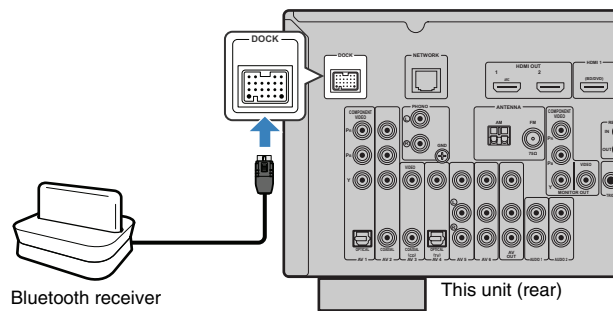

- 2 Turn on this unit.

## Pairing Bluetooth components

Be sure to perform pairing when connecting a Bluetooth component to the Bluetooth receiver for the first time, or when the pairing setting has been deleted.



- The Yamaha Bluetooth receiver (YBA-10) can be paired with up to eight Bluetooth components. When the ninth component is paired, the pairing setting for the component which has not been used for the longest period of time will be deleted.
- Texts in parentheses denote indications on the front display.

- 1 Press DOCK to select “DOCK” as the input source.
- 2 Turn on your Bluetooth component and set it to the pairing mode.
- 3 Press OPTION, use the cursor keys to select “Pairing” (Pairing), and then press ENTER.

Searching starts. If your Bluetooth component recognizes the Bluetooth receiver, the model name (such as “YBA-10 YAMAHA”) will be displayed in the device list of your component.



- To cancel the search, press RETURN.
- You can also start the search by holding down MEMORY instead of step 3. (To cancel the search, press MEMORY again.)

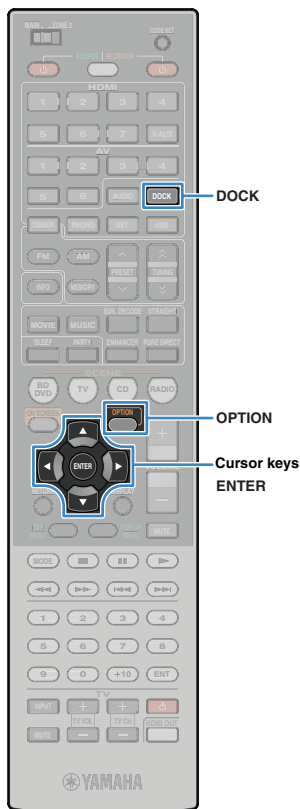

#### 4 Select the Bluetooth receiver from the device list and enter the pass key “0000”.

“Completed” appears when the pairing is complete.



- Depending on Bluetooth components, “BT connected” appears when the pairing is complete. In this case, the wireless connection has been already established. You just need to start playback on your Bluetooth component to enjoy it on this unit.

#### 5 To exit from the menu, press OPTION.

## Establishing a wireless connection and playing back

When the pairing is complete, follow the procedure below to establish a wireless connection between your Bluetooth component and the Bluetooth receiver. When the connection is established, this unit outputs sounds played back on the Bluetooth component.



- Depending on Bluetooth components, a wireless connection is established automatically or by operating the Bluetooth component. In this case, you can skip steps 2 and 3 below.
- Texts in parentheses denote indications on the front display.

- 1 Press **DOCK** to select “DOCK” as the input source.
- 2 Press **OPTION**.
- 3 Use the cursor keys to select “Connect” (Connect) and then press **ENTER**.

“BT connected” appears when the wireless connection is established.



- If the Bluetooth receiver is paired with more than one Bluetooth component, the lastly-connected component is automatically chosen. When you cannot establish a connection with an intended component, perform pairing again or perform the connection operation from the intended component.
- “Not found” appears if a connection cannot be established. Check the followings and try again.
  - The Bluetooth component and Bluetooth receiver are paired.
  - The Bluetooth component is turned on and the Bluetooth mode is enabled.
  - The Bluetooth component is within 10 m of the Bluetooth receiver.

#### 4 Start playback on your Bluetooth component.



- To terminate the wireless connection, select “Disconnect” (Disconnect) in step 3.

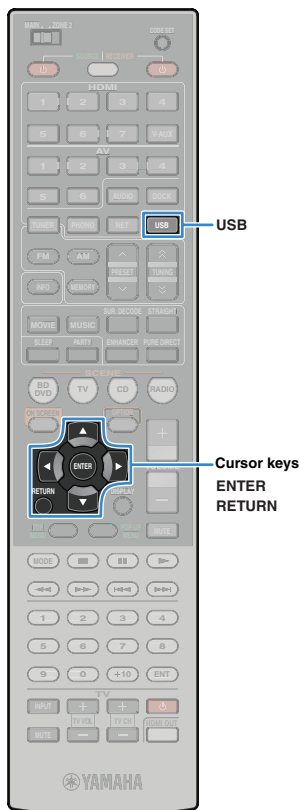

## Playing back music stored on a USB storage device

You can play back music files stored on a USB storage device on this unit. Refer to the instruction manuals of the USB storage device in addition.

This unit supports USB mass storage class devices (FAT 16 or FAT 32 format, except USB HDDs).



- This unit supports playback of WAV (PCM format only), MP3, WMA, MPEG-4 AAC and FLAC files.
- This unit is compatible with sampling frequency of up to 96 kHz for WAV and FLAC files, and 48 kHz for other files.

## Connecting a USB storage device

### 1 Connect the USB storage device to the USB jack.

This unit (front)

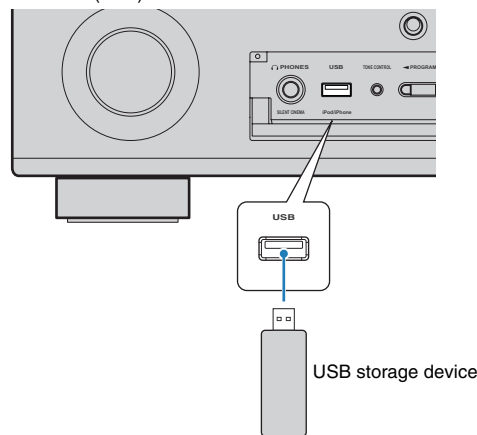

- If the USB storage device contains many files, it may take time to load the files. In this case, "Loading" appears in the front display.

## Playback of USB storage device contents

Follow the procedure below to operate the USB storage device contents and start playback.

### 1 Press USB to select "USB" as the input source.

The browse screen is displayed on the TV.



- If playback is ongoing on your USB storage device, the playback screen is displayed.

### 2 Use the cursor keys to select an item and press ENTER.

If a song is selected, playback starts and the playback screen is displayed.

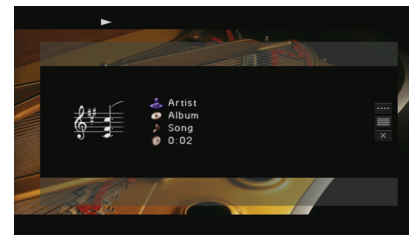

- To return to the previous screen, press RETURN.
- Files not supported by this unit are not listed.
- You can register your favorite items as shortcuts (p.71) and access them directly by selecting the shortcut numbers.



Menu operation keys  
 Cursor keys  
 ENTER  
 RETURN

External device  
 operation keys

## ■ Browse screen

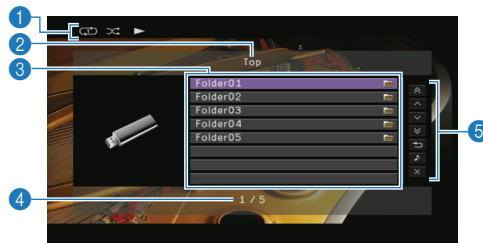

- 1 **Status indicators**  
 Display the current shuffle/repeat settings (p.61) and playback status.
- 2 **List name**
- 3 **Contents list**  
 Displays the list of USB storage device contents. Use the cursor keys to select an item and press ENTER to confirm the selection.
- 4 **Item number/total**
- 5 **Operation menu**  
 Use the cursor keys to select an item and press ENTER to confirm the selection.

Menu	Function
<b>1 Page Up</b>	Moves to the previous/next page of the list.
<b>1 Page Down</b>	
<b>10 Pages Up</b>	Moves to 10 pages forward/backward.
<b>10 Pages Down</b>	
<b>Return</b>	Returns to the higher-level list.
<b>Now Playing</b>	Moves to the playback screen.
<b>Screen Off</b>	Closes the screen display and shows the background. Press one of the menu operation keys to redisplay it.

## ■ Playback screen

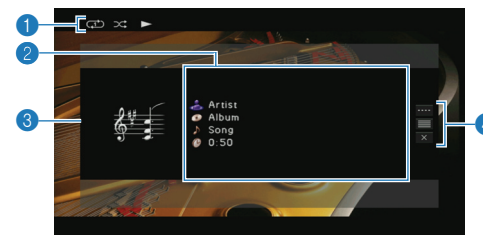

- 1 **Status indicators**  
 Display the current shuffle/repeat settings (p.61) and playback status.
- 2 **Playback information**  
 Displays the artist name, album name, song title and elapsed time. Use the cursor keys to select information to be scrolled.
- 3 **Album image**
- 4 **Operation menu**  
 Use the cursor keys to select an item and press ENTER to confirm the selection. To close the submenu, press RETURN.

Menu	Submenu	Function
<b>Play Control</b>	■	Stops playback.
	⏮	Skips forward/backward.
	⏭	
<b>Browse</b>		Moves to the browse screen.
<b>Screen Off</b>		Closes the screen display and shows the background. Press one of the menu operation keys to redisplay it.



- You can also use the external device operation keys (▶, ■, ⏮, ⏭) on the remote control to control playback.

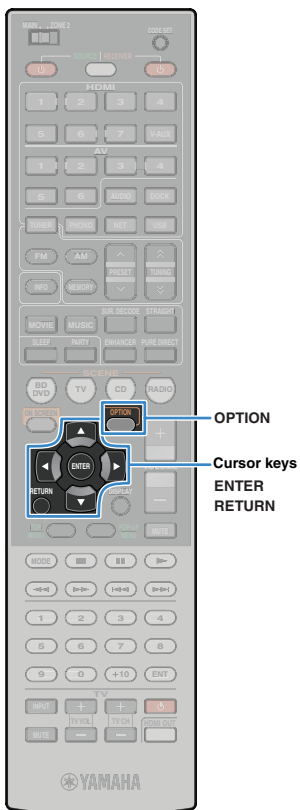

## ■ Shuffle/repeat settings

You can configure the shuffle/repeat settings for playback of USB storage device contents.



- The shuffle/repeat settings are shared by USB and network sources.

**1** When “USB” is selected as the input source, press **OPTION**.

**2** Use the cursor keys to select “Shuffle” (Shuffle) or “Repeat” (Repeat) and press **ENTER**.



- To return to the previous screen during menu operations, press RETURN.
- Texts in parentheses denote indications on the front display.

**3** Use the cursor keys (</>) to select a setting and press **ENTER**.

Item	Setting	Function
<b>Shuffle (Shuffle)</b>	Off (Off)	Turns off the shuffle function.
	On (On)	Plays back songs in the current album (folder) in random order. “⌘” appears in the TV screen.
<b>Repeat (Repeat)</b>	Off (Off)	Turns off the repeat function.
	Single (Single)	Plays back the current song repeatedly. “↺” appears in the TV screen.
	All (All)	Plays back all songs in the current album (folder) repeatedly. “↻” appears in the TV screen.

**4** To exit from the menu, press **OPTION**.

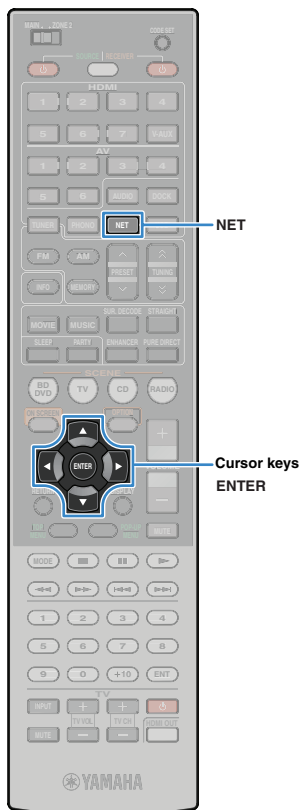

## Playing back music stored on PCs

You can play back music files stored on your PC or DLNA-compatible NAS on this unit.



- To use this function, this unit and your PC must be connected to the network properly (p.30). You can check whether the network parameters (IP address, etc.) are properly assigned to this unit in “Network” (p.100) in the “Information”.
- This unit supports playback of WAV (PCM format only), MP3, WMA, MPEG-4 AAC and FLAC files.
- This unit is compatible with sampling frequency of up to 96 kHz for WAV and FLAC files, and 48 kHz for other files.
- To play back FLAC files, you need to install server software that supports sharing of FLAC files via DLNA on your PC or use a NAS that supports FLAC files.

### Requirements

This unit can play back music files stored on the following music servers.

- PC with Windows Media Player 11 or later installed
- PC with DLNA/UPnP certificate server software installed
- NAS with DLNA/UPnP certification

## Media sharing setup

To play back music files stored on your PC or DLNA-compatible NAS, first you need to configure the media sharing setting on each music server.

### ■ For a PC with Windows Media Player installed

- 1 Check that Windows Media Player 11 or later is installed on your PC.
- 2 In the media sharing settings, enable the media sharing and select this unit as a device to which the media is shared.

### ■ For a NAS or a PC with other DLNA sever software installed

Refer to the instruction manual of the device or software and configure the media sharing setting.

## Playback of PC music contents

Follow the procedure below to operate the PC music contents and start playback.

- 1 Press NET repeatedly to select “PC” as the input source.

The browse screen is displayed on the TV.

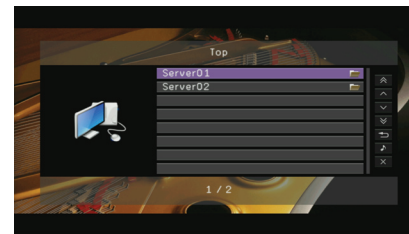

- If playback of a music file selected from this unit is ongoing on your PC, the playback screen is displayed.

- 2 Use the cursor keys to select a music server and press ENTER.

- 3 Use the cursor keys to select an item and press ENTER.

If a song is selected, playback starts and the playback screen is displayed.

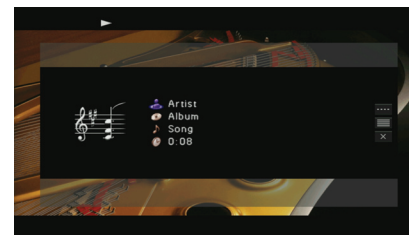



Menu operation keys  
Cursor keys  
ENTER  
RETURN

External device  
operation keys



- To return to the previous screen, press RETURN.
- Files not supported by this unit are not listed (or cannot be selected even if listed).
- You can register your favorite items as shortcuts (p.71) and access them directly by selecting the shortcut numbers.

## Browse screen

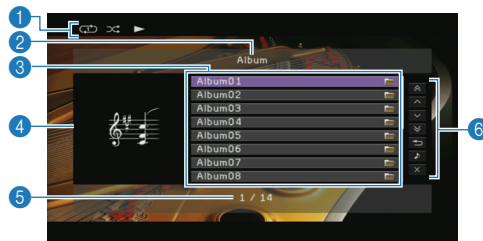

- Status indicators**  
Display the current shuffle/repeat settings (p.64) and playback status (play/pause).
- List name**
- Contents list**  
Displays the list of PC contents. Use the cursor keys to select an item and press ENTER to confirm the selection.
- Album image**
- Item number/total**
- Operation menu**  
Use the cursor keys to select an item and press ENTER to confirm the selection.

Menu	Function
<b>1 Page Up</b>	Moves to the previous/next page of the list.
<b>1 Page Down</b>	
<b>10 Pages Up</b>	Moves to 10 pages forward/backward.
<b>10 Pages Down</b>	
<b>Return</b>	Returns to the higher-level list.
<b>Now Playing</b>	Moves to the playback screen.
<b>Screen Off</b>	Closes the screen display and shows the background. Press one of the menu operation keys to redisplay it.

## Playback screen

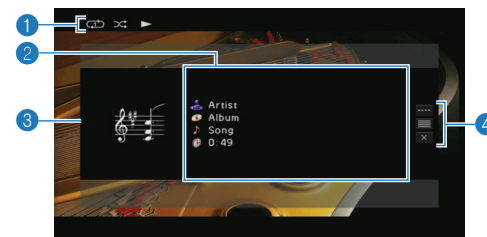

- Status indicators**  
Display the current shuffle/repeat settings (p.64) and playback status (play/pause).
- Playback information**  
Displays the artist name, album name, song title and elapsed time. Use the cursor keys to select information to be scrolled.
- Album image**
- Operation menu**  
Use the cursor keys to select an item and press ENTER to confirm the selection. To close the submenu, press RETURN.

Menu	Submenu	Function
	▶	Resumes playback from pause.
	■	Stops playback.
<b>Play Control</b>	■ ■	Stops playback temporarily.
	⏮	Skips forward/backward.
	⏭	
<b>Browse</b>		Moves to the browse screen.
<b>Screen Off</b>		Closes the screen display and shows the background. Press one of the menu operation keys to redisplay it.



- You can also use the external device operation keys (▶, ■, ■ ■, ⏮, ⏭) on the remote control to control playback.
- You can also use a DLNA-compatible Digital Media Controller (DMC) to control playback. For details, see "DMC Control" (p.80).

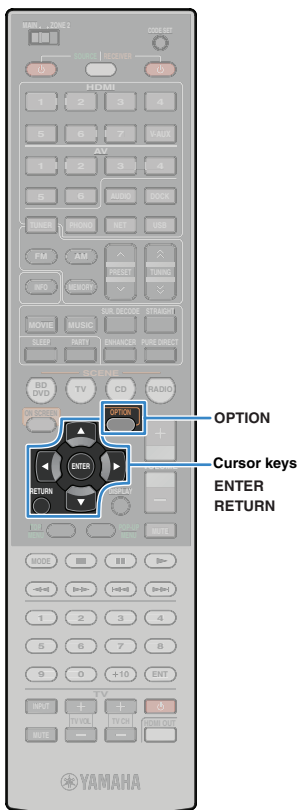

## ■ Shuffle/repeat settings

You can configure the shuffle/repeat settings for playback of PC music contents.



- The shuffle/repeat settings are shared by USB and network sources.



**1** When “PC” is selected as the input source, press **OPTION**.

**2** Use the cursor keys to select “Shuffle” (Shuffle) or “Repeat” (Repeat) and press **ENTER**.



- To return to the previous screen during menu operations, press RETURN.
- Texts in parentheses denote indications on the front display.

**3** Use the cursor keys (</>) to select a setting and press **ENTER**.

Item	Setting	Function
<b>Shuffle (Shuffle)</b>	Off (Off)	Turns off the shuffle function.
	On (On)	Plays back songs in the current album (folder) in random order. “  ” appears in the TV screen.
<b>Repeat (Repeat)</b>	Off (Off)	Turns off the repeat function.
	Single (Single)	Plays back the current song repeatedly. “  ” appears in the TV screen.
	All (All)	Plays back all songs in the current album (folder) repeatedly. “  ” appears in the TV screen.

**4** To exit from the menu, press **OPTION**.





NET

Menu operation keys  
Cursor keys  
ENTER  
RETURN

## Listening to Internet radio

You can listen to Internet radio stations using the vTuner Internet radio station database service particularly customized for this unit, providing a database of numerous radio stations in the world.



- To use this function, this unit must be connected to the Internet (p.30). You can check whether the network parameters (IP address, etc.) are properly assigned to this unit in "Network" (p.100) in the "Information".
- This service may be discontinued without notice.
- Some Internet radio stations may not be played.

### 1 Press NET repeatedly to select "NET RADIO" as the input source.

The browse screen is displayed on the TV.



### 2 Use the cursor keys to select an item and press ENTER.

If an Internet radio station is selected, playback starts and the playback screen is displayed.



- To return to the previous screen, press RETURN.
- You can register your favorite Internet radio stations as shortcuts (p.71) and access them directly by selecting the shortcut numbers.

## Browse screen

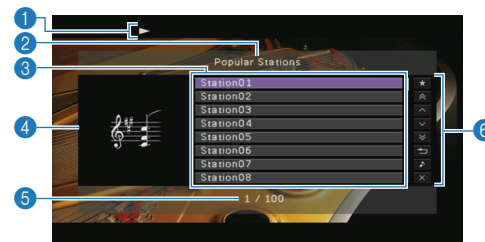

#### 1 Playback indicator

#### 2 List name

#### 3 Contents list

Displays the list of Internet radio contents. Use the cursor keys to select an item and press ENTER to confirm the selection.

#### 4 Station art

#### 5 Item number/total

#### 6 Operation menu

Use the cursor keys to select an item and press ENTER to confirm the selection.

Menu	Function
<b>Bookmark On</b>	Adds the station selected in the list to "Bookmarks".
<b>1 Page Up</b>	Moves to the previous/next page of the list.
<b>1 Page Down</b>	
<b>10 Pages Up</b>	Moves to 10 pages forward/backward.
<b>10 Pages Down</b>	
<b>Return</b>	Returns to the higher-level list.
<b>Now Playing</b>	Moves to the playback screen.
<b>Screen Off</b>	Closes the screen display and shows the background. Press one of the menu operation keys to redisplay it.

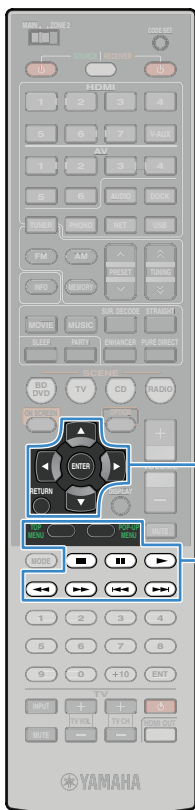

Menu operation keys  
Cursor keys  
ENTER  
RETURN

External device operation keys



- By adding your favorite Internet radio stations to “Bookmarks”, you can access to them quickly from “Bookmarks”. To remove stations from “Bookmarks”, select the station in “Bookmarks” and then “Bookmark Off”.
- You can also register your favorite Internet radio stations by accessing the following website with the web browser on your PC. To use this feature, you need the vTuner ID of this unit and your e-mail address to create your personal account. You can check the vTunerID (MAC address of this unit) in the “Network” screen (p.100) in the “Information” menu.  
<http://yradio.vtuner.com/>



- You can also use the external device operation keys (▶, ■) on the remote control to control playback.

## ■ Playback screen

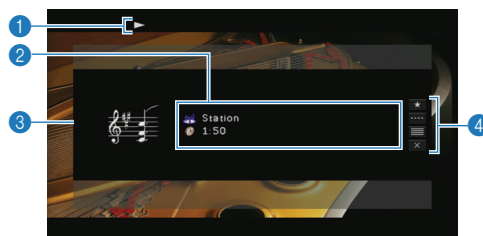

### 1 Playback indicators

### 2 Playback information

Displays the station name and elapsed time.

### 3 Station art

### 4 Operation menu

Use the cursor keys to select an item and press ENTER to confirm the selection.

To close the submenu, press RETURN.

Menu	Submenu	Function
<b>Bookmark On</b>		Adds the current station to “Bookmarks”.
<b>Play Control</b>	■	Stops playback.
<b>Browse</b>		Moves to the browse screen.
<b>Screen Off</b>		Closes the screen display and shows the background. Press one of the menu operation keys to redisplay it.

## Playing back music in multiple rooms (multi-zone)

The multi-zone function allows you to play back separate input sources in the room where this unit is installed (main zone) and another room (Zone2).

For example, while you are watching a TV in the living room (main zone), another person can listen to radio in the bedroom (Zone2).

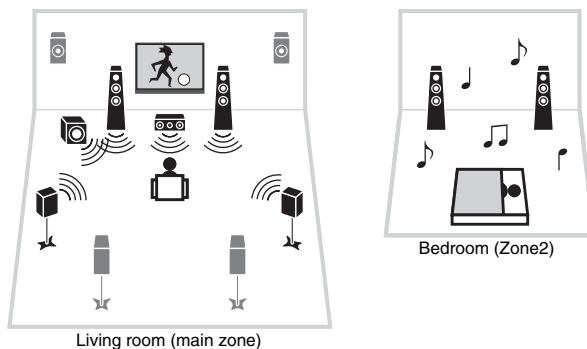

- Only analog audio signals (including radio, USB and network sources) can be output to Zone2. To listen to playback sounds of an external device in Zone2, you need to connect the device to the AUDIO jacks (AV5~6, AUDIO1~2 or VIDEO AUX jacks) of this unit. The party mode (p.70) allows you to enjoy main zone sources in Zone2 simultaneously regardless of input audio signal types.

### Preparing for Zone2

Connect devices to be set in Zone2 to this unit. The connection method varies depending on an amplifier to use (this unit or external amplifier).

#### Caution

- Remove the power cable of this unit from an AC wall outlet before connecting speakers or an external amplifier.
- Be careful that the core of the speaker cable does not touch anything or come into contact with the metal areas of this unit. This may damage this unit or the speakers. If the speaker cables short circuit, "CHECK SP WIRES" will appear on the front display when this unit is turned on.

### Using the internal amplifier of this unit

Connect the speakers placed in Zone2 to this unit with speaker cables.

To utilize the EXTRA SP terminals for Zone2 speakers, set "Power Amp Assign" (p.89) in the "Setup" menu to "7ch +1ZONE" after connecting the power cable to an AC wall outlet.

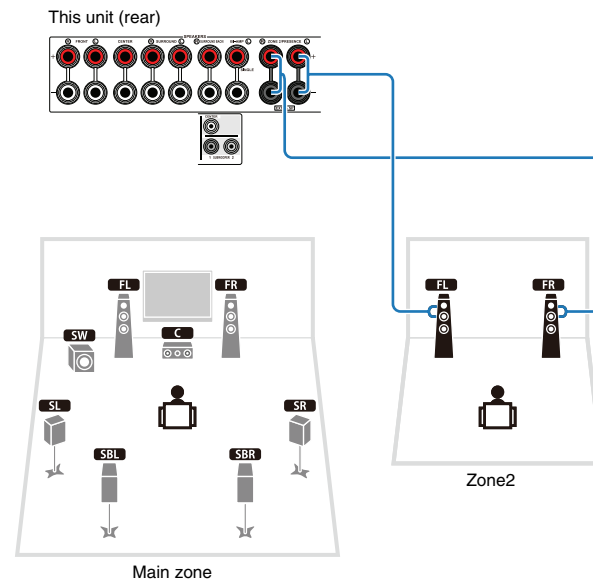

- When Zone2 output is enabled (p.69), the surround back speakers in the main zone do not output sound.

## ■ Using an external amplifier

Connect the external amplifier placed in Zone2 to this unit with a stereo pin cable.

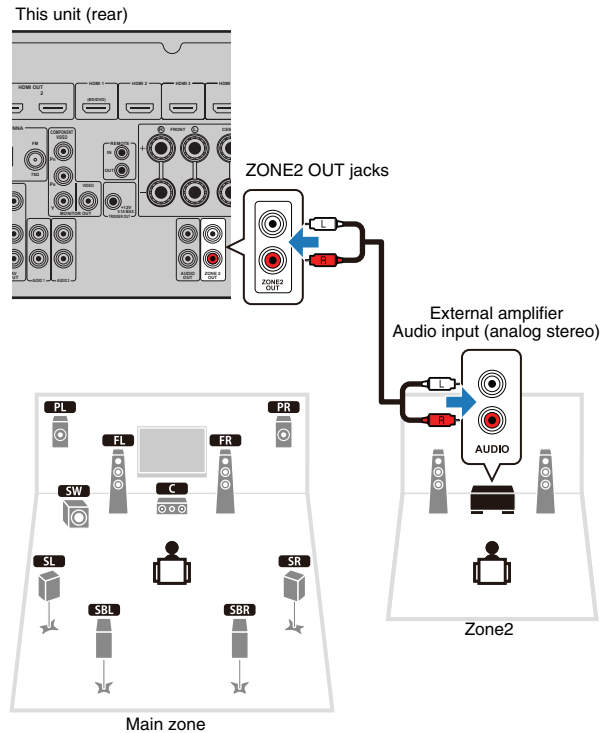

## ■ Operating this unit from Zone2 (remote connection)

By connecting an infrared signal receiver/emitter to the REMOTE IN/OUT jacks of this unit, you can operate this unit and external devices from Zone2 with the supplied remote control.



- To operate external devices with the supplied remote control, register a remote control code for each device in advance (p.104).

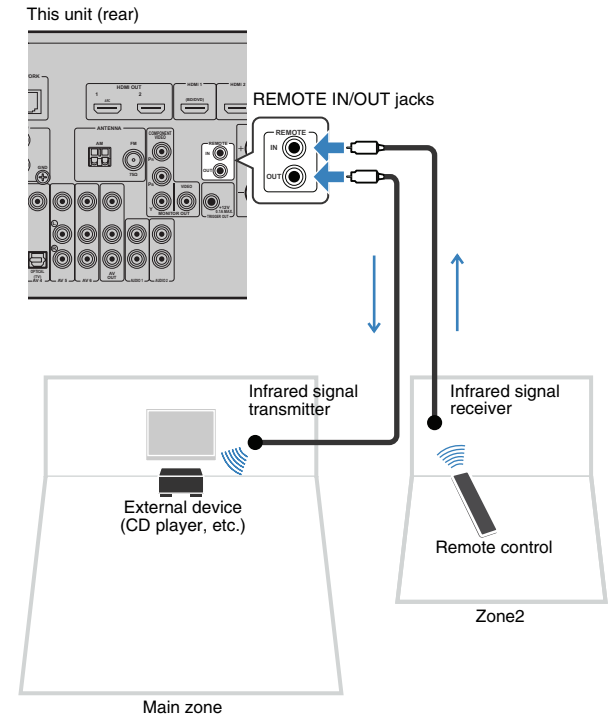



## Remote connections between Yamaha products

If you are using Yamaha products that support remote connections like this unit, an infrared signal transmitter is unnecessary. You can transmit remote control signals by connecting the REMOTE IN/OUT jacks with monaural mini-jack cables and an infrared signal receiver.

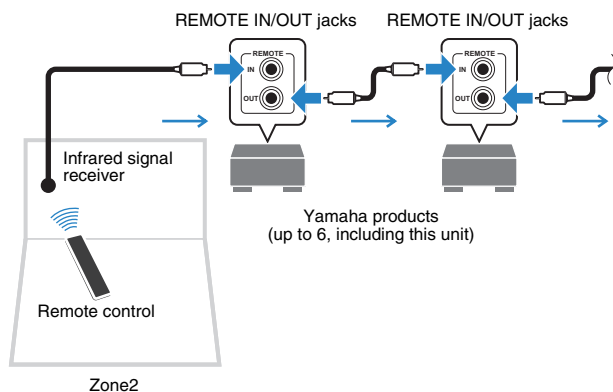

## Controlling Zone2

- 1** Set MAIN/ZONE2 to “ZONE2”.
- 2** Press RECEIVER 

Each time you press the key, Zone2 output is enabled or disabled.  
When Zone2 output is enabled, “ZONE2” lights up in the front display.
- 3** Use the following keys to select an input source.
  - V-AUX:** VIDEO AUX (AUDIO) jacks (on the front panel)
  - AV5-6:** AV5-6 (AUDIO) jacks
  - AUDIO:** AUDIO1-2 jacks (press repeatedly to switch between “AUDIO1” and “AUDIO2”)
  - DOCK:** DOCK jack
  - TUNER:** FM/AM radio
  - PHONO:** PHONO jacks
  - NET:** NETWORK jack (press repeatedly to select a desired network source)
  - USB:** USB jack (on the front panel)



- You cannot select USB and network sources exclusively for each zone. For example, if you select “PC” for Zone2 when “USB” is selected for the main zone, the input source for the main zone also switches to “PC”.

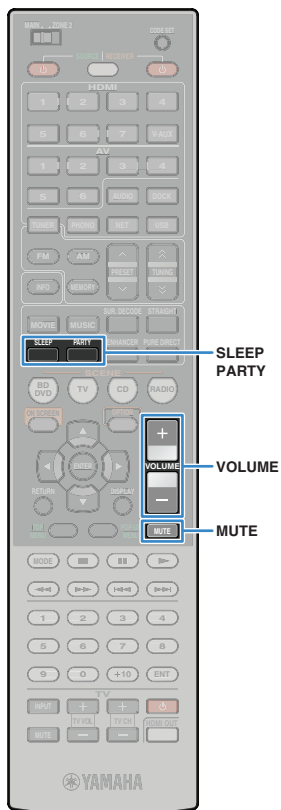

#### 4 Start playback on the external device, or select a radio station.

Refer to the instruction manual of the external device. For details on the following operations, see the corresponding pages.

- Listening to FM/AM radio (p.49)
- Playing back iPod music (p.52)
- Playing back music via Bluetooth (p.57)
- Playing back music stored on a USB storage device (p.59)
- Playing back music stored on PCs (p.62)
- Listening to Internet radio (p.65)



- The on-screen operations are not available for Zone2. Use the front display or web control (p.72) to control Zone2.



- To set the sleep timer (120 min, 90 min, 60 min, 30 min, off), press SLEEP repeatedly. The Zone2 output will be disabled after a specified period of time.
- To adjust the Zone2 volume, press VOLUME or MUTE (available only when using the internal amplifier of this unit).

#### Caution

- To avoid unexpected noise, never play back DTS-CDs in Zone2.

#### ■ Enjoying main zone sources in Zone2 (party mode)

The party mode allows you to enjoy main zone sources in Zone2 simultaneously. During the party mode, stereo playback is automatically selected for all zones. Utilize this function when you want to play back main sources as background music in a home party, etc.

#### 1 Press PARTY.

Each time you press the key, the party mode is turned on or off.

When the party mode is turned on, "PARTY" lights up in the front display.



- If the party mode does not work on Zone2, set "Party Mode Set" (p.97) in the "Setup" menu to "Enable" (default).

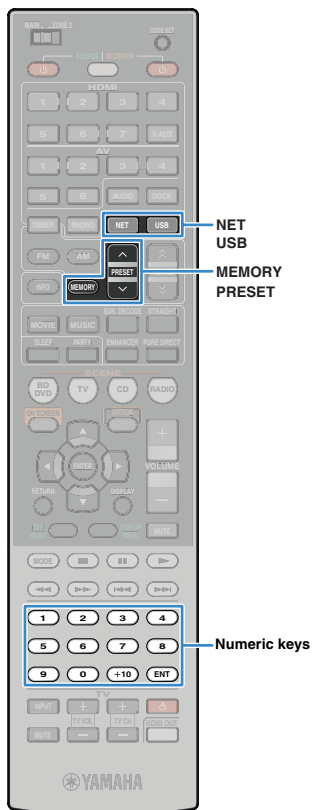

## Useful functions

### Registering favorite items (shortcut)

You can register up to 40 favorite USB and network contents as shortcuts and access them directly by selecting the shortcut numbers.



- You can also use the "Bookmarks" feature to register Internet radio stations (p.65).

### Registering an item

Select a desired item and register it to a shortcut number.

- 1 Play back a song or a radio station to be registered.
- 2 Press MEMORY.



Shortcut number (flashes)



- To change a shortcut number to which the item will be registered, use PRESET or numeric keys to select the shortcut number after step 2.



"Empty" (not in use) or item currently registered

- 3 To confirm the registration, press MEMORY.

### Recalling a registered item

Recall a registered item by selecting the shortcut number.

- 1 Press NET or USB.
- 2 Press PRESET repeatedly to select a desired item.

You can also enter a shortcut number (01 to 40) directly by using the numeric keys.



- "No Presets" appears when no items are registered.
- "Empty" appears when a preset number not in use is entered.
- The registered item cannot be recalled in the following cases.
  - A USB storage device which contains the registered item is not connected to this unit.
  - A PC which contains the registered item is turned off or not connected to the network.
  - The registered network content is temporarily unavailable or out of service.
  - The registered item (file) has been deleted or moved to another location.
- When you register music files stored on a USB storage device or a PC, this unit memorizes the relative position of the music files in the folder. If you have added or deleted any music files to or from the folder, this unit may not recall the music file correctly. In such cases, register the items again.

## Controlling this unit from the web browser (web control)

You can control this unit with the web control screen displayed in the web browser.

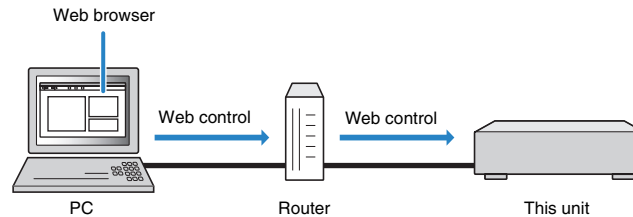

- To use this function, this unit and your PC must be connected to the network properly (p.30).
- Some security software installed on your PC may block the access of this unit to your PC. In such cases, configure the security software appropriately.
- We recommend using Internet Explorer 7.x or 8.x as a web browser.



- If you set "Network Standby" (p.73) to "On", you can display the web control screen even when this unit is in standby mode.
- You can limit access to this unit from the network devices (PCs, etc.) with the MAC address filter (p.73).

### 1 Start the web browser.

### 2 Enter the IP address of this unit in the address bar of the web browser.

You can check the IP address in "Network" (p.100) in the "Information" menu.



- By adding the IP address of this unit to the bookmark of the browser, you will be able to open it without entering the IP address from the next time. However, the IP address of this unit may change if you are using a DHCP server.

## Top menu screen



### 1 CONTROL

Moves to the control screen for the selected zone.

### 2 STATUS

Turns on/off the power for each zone, or displays the input source and volume set for each zone.

### 3 SETTINGS

Moves to the settings screen.

### 4 PARTY MODE

Turns on/off the party mode (p.70).

### 5 SYSTEM POWER

Turns on/off the power for all zones.

### 6 MAIN VOLUME

Adjusts the volume or mutes the audio output for the main zone. You can also switch the step for the volume adjustment.

### 7 RELOAD

Reloads the current status of this unit.



## ■ Control screen



- 1 **PLAY INFO**  
Selects an input source or controls playback for the selected zone.
- 2 **TOP MENU**  
Moves to the top menu screen.
- 3 **SCENE**  
Select a scene for the main zone.
- 4 **POWER**  
Turns on/off the power for the selected zone.
- 5 **VOLUME**  
Adjusts the volume or mutes the audio output for the selected zone. You can also switch the step for the volume adjustment. (These functions are available only when the internal amplifier of this unit is used.)
- 6 **RELOAD**  
Reloads the current status of this unit.

## ■ Settings screen

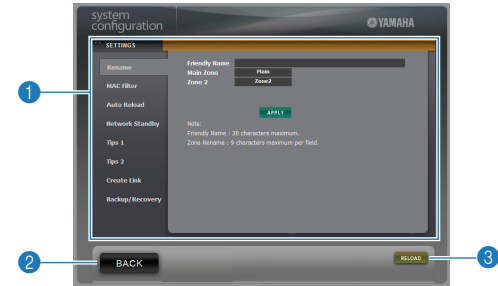

- 1 **Rename**  
Edits the friendly name (name for this unit in the network) or the name of each zone (p.97). Click "APPLY" to apply the changes to this unit.  
**MAC Filter**  
Sets the MAC address filter (p.96) to limit access to this unit from the network devices. Click "APPLY" to apply the changes to this unit.  
**Auto Reload**  
Enables/disables automatic reloading. When "Auto Reload" is "On" (enabled), the web control screen reloads the status of this unit every 5 seconds.  
**Network Standby**  
Enables/disables the network standby function (p.96).  
**Tips 1/2**  
Displays the tips for use of the web control.  
**Create Link**  
Creates a shortcut link to the desired control screen.  
**Backup/Recovery**  
Creates backup of the settings of this unit on the PC, or restores the settings from the backup.
- 2 **BACK**  
Moves to the top menu screen.
- 3 **RELOAD**  
Reloads the current status of this unit.

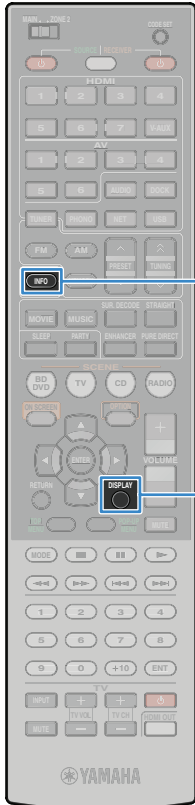

INFO

DISPLAY

**Note**

- Do not operate this unit during the recovery process (restoring the settings). Otherwise, the settings may not be restored correctly. When the recovery finishes, click "OK" to set this unit to standby mode.
- The backup does not contain user information (user account, password, etc.) or unit-specific information (MAC address, IP address, etc).

## Viewing the current status

### Switching information on the front display

#### 1 Press INFO.

Each time you press the key, the display item switches.



Item name

About 3 seconds later, the corresponding information appears.



Information



- Available items vary depending on the selected input source. Also, the display item can be applied separately to each input source group.

Input source group	Item
HDMI1~7 V-AUX AV1~6 AUDIO1~2 PHONO	Input (input source name), DSP Program (sound mode name), Audio Decoder (decoder name)
TUNER	Frequency (frequency), DSP Program (sound mode name), Audio Decoder (decoder name)

	Song (song title), Artist (artist name), Album (album name), DSP Program (sound mode name), Audio Decoder (decoder name)
<b>DOCK</b>	* When using iPod wireless system, Bluetooth receiver, or during simple play: Input (input source name), DSP Program (sound mode name), Audio Decoder (decoder name)
<b>PC USB</b>	Song (song title), Artist (artist name), Album (album name), DSP Program (sound mode name), Audio Decoder (decoder name)  * When iPod is connected via USB, the display item switches in the same manner as "DOCK".
<b>NET RADIO</b>	Station (station name), DSP Program (sound mode name), Audio Decoder (decoder name)

### Viewing the status information on the TV

#### 1 Press DISPLAY.

The following information is displayed on the TV.

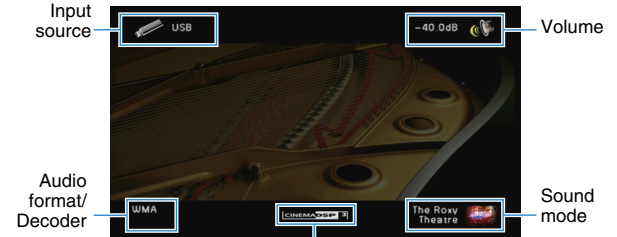

CINEMA DSP status

#### 2 To close the information display, press DISPLAY.

## Configuring settings in accordance with a playback source (Option menu)

You can configure the playback-related settings in accordance with a playback source. Since this menu is operational on the front panel (or on the TV screen), you can easily configure the settings during playback.

### 1 Press **OPTION**.



Front display



TV screen

### 2 Use the cursor keys to select an item and press **ENTER**.



- To return to the previous screen during menu operations, press **RETURN**.

### 3 Use the cursor keys (**◀/▶**) to select a setting and press **ENTER**.

### 4 To exit from the menu, press **OPTION**.

## Option menu items



- Available items vary depending on the selected input source.
- Texts in parentheses denote indications on the front display.

Item	Function	Page
<b>Tone Control (Tone Control)</b>	Adjusts the high-frequency range and low-frequency range of sounds.	76
<b>Adaptive DRC (Adaptive DRC)</b>	Sets whether dynamic range (from maximum to minimum) is adjusted automatically in conjunction with adjusting the volume level.	76
<b>CINEMA DSP 3D Mode (CINEMA DSP 3D)</b>	Enables/disables CINEMA DSP 3D.	76
<b>Dialogue Lift (Dialogue Lift)</b>	Adjusts the vertical position of center sound when presence speakers are used.	76
<b>Extended Surround (EXTD Surround)</b>	Selects the 5.1 to 7.1-channel signal playback method when surround back speakers are used.	77
<b>Volume Trim (Volume Trim)</b>	Corrects volume differences between input sources.	77
<b>Enhancer (Enhancer)</b>	Enables/disables Compressed Music Enhancer.	77
<b>Shuffle (Shuffle)</b>	Configures the shuffle setting for the iPod (p.56), USB storage device (p.61) or PC (p.64).	—
<b>Repeat (Repeat)</b>	Configures the repeat setting for the iPod (p.56), USB storage device (p.61) or PC (p.64).	—
<b>Connect/Disconnect (Connect/Disconnect)</b>	Establishes/terminates a wireless connection between your Bluetooth component and the Bluetooth receiver.	58
<b>Pairing (Pairing)</b>	Performs pairing of your Bluetooth component and the Bluetooth receiver.	57

## ■ Tone Control (Tone Control)

Adjusts the high-frequency range (Treble) and low-frequency range (Bass) of speaker sounds. When connecting headphones, you can adjust high-frequency range and low-frequency range of sounds output from headphones.

### Choices

Treble (Treble), Bass (Bass)

### Setting range

-6.0dB ~ Bypass (Bypass) ~ +6.0dB \*0.5dB steps

### Default

Bypass (Bypass)



- If you set the balance extremely off, sounds may not match those from other channels well.

### Adjusting with the front panel controls

- ① Press TONE CONTROL to select “Treble” or “Bass”.
- ② Press PROGRAM to make an adjustment.

## ■ Adaptive DRC (Adaptive DRC)

Sets whether dynamic range (from maximum to minimum) is adjusted automatically in conjunction with adjusting the volume level. When it is set to “On”, it is useful for listening to playback at low volume at night.

### Settings

On (On)	Adjusts the dynamic range automatically.
Off (Off) (default)	Does not adjust the dynamic range automatically.

If “On” is selected, the dynamic range becomes narrow at a low volume, and becomes wide at a high volume.

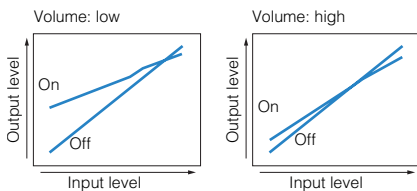

## ■ CINEMA DSP 3D Mode (CINEMA DSP 3D)

Enables/disables CINEMA DSP 3D. If this function is set to “On”, CINEMA DSP 3D functions according to the selected sound programs (except 2ch Stereo and 7ch Stereo).

### Settings

On (On) (default)	Enables CINEMA DSP 3D.
Off (Off)	Disables CINEMA DSP 3D.

## ■ Dialogue Lift (Dialog Lift)

Adjusts the vertical position of center sound such as dialogues when presence speakers are used. If dialogues are heard from a position lower than the TV screen, adjust this setting to raise the position.

### Setting range

0~5 (higher raises the position)

### Default

0

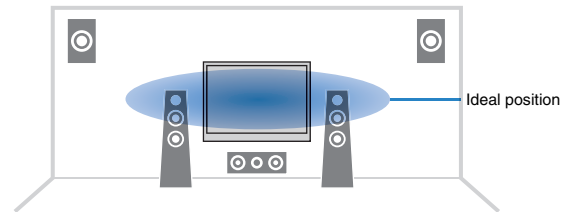

## Extended Surround (EXTD Surround)

Selects how to play back 5.1- to 7.1-channel sources when surround back speakers are used.

### Settings

Auto (Auto) (default)	Automatically selects the most suitable decoder if a flag for reproducing surround back channel is present, and reproduces the signals in 6.1- or 7.1-channel. When the DTS or DTS-HD signal is input, the unit reproduces the signal in 7.1-channel regardless of a flag for surround back channel.
<input checked="" type="checkbox"/> PLIIx Movie ( <input checked="" type="checkbox"/> PLIIxMo)	Always reproduces signals in 7.1-channel using the Dolby Pro Logic IIx Movie decoder. This setting is available only when two surround back speakers are connected.
<input checked="" type="checkbox"/> PLIIx Music ( <input checked="" type="checkbox"/> PLIIxMu)	Always reproduces signals in 6.1- or 7.1-channel using the Dolby Pro Logic IIx Music decoder. This setting is available only when one or two surround back speakers are connected.
EX/ES (EX/ES)	Automatically selects the most suitable decoder, and reproduces signals in 6.1-channel.
Off (Off)	Always reproduces signals in original channels.

## Volume Trim (Volume Trim)

Corrects volume differences between input sources. If you are bothered by volume differences when switching between input sources, use this function to correct it.



- This setting is applied separately to each input source.

### Setting range

-6.0dB ~ +6.0dB (0.5dB steps)

### Default

0.0dB

## Enhancer (Enhancer)

Enables/disables Compressed Music Enhancer (p.48).



- This setting is applied separately to each input source.

### Settings

Off (Off)	Disables Compressed Music Enhancer.
On (On)	Enables Compressed Music Enhancer.

### Default

TUNER, DOCK, (network sources), USB: On (On)

Others: Off (Off)

# CONFIGURATIONS

## Configuring input sources (Input menu)

You can change the input source settings using the TV screen.

- 1 Press ON SCREEN.
- 2 Use the cursor keys to select “Input” and press ENTER.

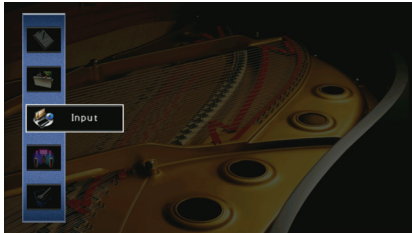

- 3 Use the cursor keys (◀/▶) to select an input source to be configured and press the cursor key (△).

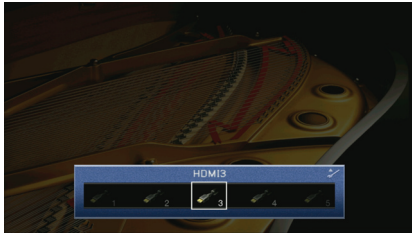

The input source of this unit also changes.



- You can still switch the input source by using cursor keys (◀/▶) after step 3.

- 4 Use the cursor keys (△/▽) to select an item and press ENTER.



- To return to the previous screen during menu operations, press RETURN.

- 5 Use the cursor keys to select a setting and press ENTER.
- 6 To exit from the menu, press ON SCREEN.

## Input menu items



- Available items vary depending on the selected input source.

Item	Function	Page
<b>Rename/Icon Select</b>	Changes the input source name and icon.	79
<b>Audio In</b>	Combines the video jack of the selected input source with an audio jack of others.	79
<b>Decoder Mode</b>	Sets the format of digital audio playback to DTS.	79
<b>Standby Charge</b>	Selects whether to charge the iPod when this unit is in standby mode.	79
<b>iPod Interlock</b>	Selects whether to control this unit in conjunction with iPod operations.	80
<b>Video Out</b>	Selects a video to be output with the audio input source.	80
<b>DMC Control</b>	Selects whether to allow a DLNA-compatible Digital Media Controller (DMC) to control playback.	80

## Rename/Icon Select

Changes the input source name and icon displayed on the front display or TV screen.

### Input sources

HDMI1~7, AV1~6, V-AUX, AUDIO1~2, PHONO, USB, DOCK

### Setup procedure

- 1 Use the cursor keys (</>) to select an icon and press the cursor key (▼).
- 2 Press ENTER, use the cursor keys to rename, and then press ENTER again.

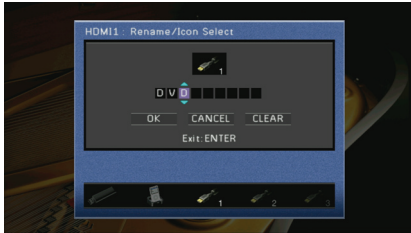

- 3 Use the cursor keys to select “OK” and press ENTER.



- To clear the entry, select “CLEAR”.

- 4 To exit from the menu, press ON SCREEN.

## Audio In

Combines the video jack of the selected input source with an audio jack of others. For example, use this function in the following cases.

- Connecting a playback device that supports HDMI video output but not HDMI audio output
- Connecting a playback device that has component video jacks and analog stereo jacks (game consoles, etc.)

### Input sources

HDMI1~7, AV1~2

### Setup procedure

#### (To input audio through a digital optical jack)

Select “AV1” or “AV4”, and connect the device to the corresponding audio jacks of this unit with a digital optical cable.

#### (To input audio through a digital coaxial jack)

Select “AV2” or “AV3”, and connect the device to the corresponding audio jacks of this unit with a digital coaxial cable.

#### (To input audio through analog audio jacks)

Select “AV5”, “AV6”, “AUDIO1” or “AUDIO2”, and connect the device to the corresponding audio jacks of this unit with a stereo pin cable.

## Decoder Mode

Sets the format of digital audio playback to DTS.

For example, if this unit does not detect DTS audio and outputs noise, set “Decoder Mode” to “DTS”.

### Input sources

HDMI1~7, AV1~4, V-AUX

### Settings

Auto (default)	Automatically selects an audio format to match the input audio signal.
DTS	Selects DTS only. (Other audio signals are not reproduced.)

## Standby Charge

Selects whether to charge the iPod connected to the iPod dock or iPod wireless system when this unit is in standby mode.

### Input sources

DOCK (iPod)

### Settings

On (default)	Charges the iPod even when this unit is in standby mode.
Off	Does not charge the iPod when this unit is in standby mode.

## ■ iPod Interlock

Selects whether to control this unit in conjunction with operations of the iPod connected to the iPod wireless system.

### Input sources

DOCK (iPod)



- This function is available only when an iPod wireless system is connected to this unit.

## □ Power & Input

Selects whether to control the power and input source selection of this unit in conjunction with iPod operations.

### Settings

On (default)	Enables power and input interlocking controls. When you start playback of the iPod, this unit turns on and "DOCK" is selected as the input source. When you stop playback, this unit enters standby mode after a short time.
Off	Disables power and input interlocking controls.



- When "Power & Input" is set to "On", the iPod connected to the iPod wireless system is charged regardless of the "Standby Charge" setting (p.79).

## □ Volume

Selects whether to control the volume of this unit in conjunction with iPod operations.

### Settings

On (default)	Enables volume interlocking controls. When you adjust the iPod volume, the volume of the unit is also adjusted.
Off	Disables volume interlocking control.

## ■ Video Out

Selects a video to be output with the audio input source.

### Input sources

TUNER, (network sources), USB

### Settings

Off (default)	Does not output videos.
HDMI1~7, AV1~6, V-AUX	Outputs videos input through the corresponding video input jacks.

## ■ DMC Control

Selects whether to allow DLNA-compatible Digital Media Controller (DMC) to control playback.

### Input source

PC

### Settings

Disable	Does not allow DMCs to control playback.
Enable (default)	Allows DMCs to control playback.



- A Digital Media Controller (DMC) is a device that can control other network devices through the network. When this function is enabled, you can control playback of this unit from DMCs (Windows Media Player 12, etc.) on the same network.



## Configuring the SCENE function (Scene menu)

You can change the settings of the SCENE function (p.43) using the TV screen.

- 1 Press ON SCREEN.
- 2 Use the cursor keys to select “Scene” and press ENTER.

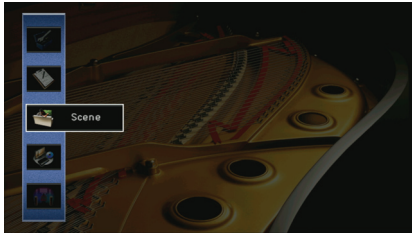

- 3 Use the cursor keys (</>) to select a scene to be configured and press the cursor key (△).

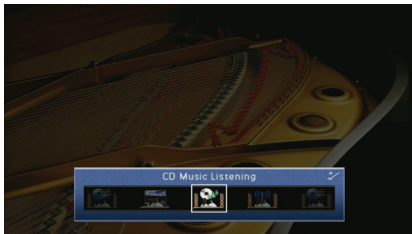

- You can still switch the scene by using cursor keys (</>) after step 3.

- 4 Use the cursor keys (△/▽) to select an item and press ENTER.



- 5 Use the cursor keys and ENTER to change the setting.
- 6 To exit from the menu, press ON SCREEN.

## Scene menu items

Item	Function	Page
Save	Registers the settings currently applied to this unit to the selected scene.	81
Load	Loads the settings registered to selected scene. You can also configure the SCENE link playback setting or view the scene assignments.	82
Rename/Icon Select	Changes the scene name and icon.	82
Reset	Restores the default settings for the selected scene.	82

### Save

Registers the settings currently applied to this unit (input source, sound program/ surround decoder and Compressed Music Enhancer on/off, and HDMI output jack) to the selected scene.



- If you have changed the input assignment for a scene, you also need to change the external device assigned to the corresponding SCENE key (p.43).

## ■ Load

Loads the settings registered to selected scene.

Select "DETAIL" to configure the SCENE link playback setting or view the scene assignments.

## □ Device Control

Enables to start playback of external devices connected to this unit via HDMI or a Yamaha product connected to the REMOTE OUT jack, in conjunction with a scene selection (SCENE link playback)

### Settings

Off	Disables the SCENE link playback function.
HDMI Control	Enables SCENE link playback using HDMI Control signals. Select this if HDMI Control-compatible device (BD/DVD players, etc.) is connected to this unit via HDMI. It also turns on the HDMI Control-compatible TV concurrently.
IR: Yamaha BD/DVD 1	Enables SCENE link playback using remote control signals. Select this if a Yamaha BD/DVD player is connected to the REMOTE OUT jack.
IR: Yamaha BD/DVD 2	Enables SCENE link playback using remote control signals. Select this if a Yamaha BD/DVD player is connected to the REMOTE OUT jack and "IR: Yamaha BD/DVD 1" does not work properly.
IR: Yamaha CD	Enables SCENE link playback using remote control signals. Select this if a Yamaha CD player is connected to the REMOTE OUT jack.

### Default

SCENE1 (BD/DVD), SCENE2 (TV): HDMI Control  
SCENE3 (CD): IR: Yamaha CD  
SCENE4 (RADIO): Off



- To control playback of an HDMI Control-compatible device by SCENE link playback, you need to set "HDMI Control" in the "Setup" menu to "On" and perform the HDMI Control link setup (p.121).

## □ Detail

Displays the assignments of the selected scene.

Input	Input source to be used
HDMI Output	HDMI OUT jack to be used
Mode	Sound program/surround decoder to be used
Enhancer	Compressed Music Enhancer on/off

## ■ Rename/Icon Select

Changes the scene name and icon displayed on the front display or TV screen.

### ■ Setup procedure

- 1 Use the cursor keys (</>) to select an icon and press the cursor key (▽).
- 2 Press ENTER, use the cursor keys to rename, and then press ENTER again.



- 3 Use the cursor keys to select "OK" and press ENTER.



- To clear the entry, select "CLEAR".
- 4 To exit from the menu, press ON SCREEN.

## ■ Reset

Restores the default settings (p.43) for the selected scene.

## Configuring sound programs/surround decoders (Sound Program menu)

You can change the settings of the sound programs and surround decoders using the TV screen.

- 1 Press **ON SCREEN**.
- 2 Use the cursor keys to select “Sound Program” and press **ENTER**.

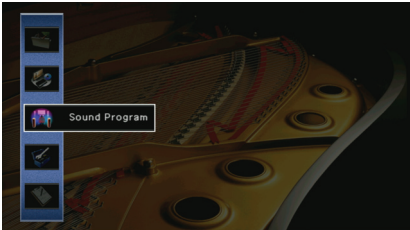

- 3 Use the cursor keys ( $\leftarrow/\rightarrow$ ) to select a sound program to be configured and press the cursor key ( $\triangle$ ).

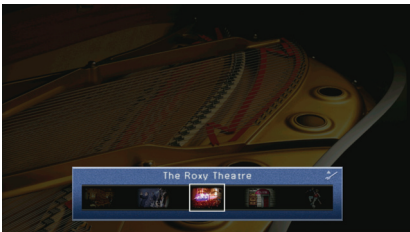

- You can still switch the sound program by using cursor keys ( $\leftarrow/\rightarrow$ ) after step 3.

- 4 Use the cursor keys ( $\triangle/\nabla$ ) to select an item and press **ENTER**.

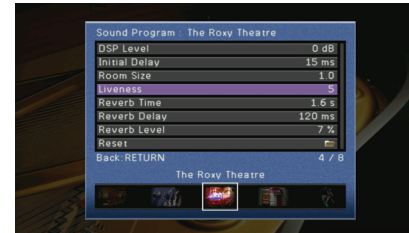

- To return to the previous screen during menu operations, press **RETURN**.
- To restore the default settings for the selected sound program, select “Reset”.

- 5 Use the cursor keys to select a setting and press **ENTER**.
- 6 To exit from the menu, press **ON SCREEN**.

## Sound Program menu items



- Available items vary depending on the selected sound program or surround decoder.

### Settings for sound programs

Item	Function	Settings
<b>Decode Type</b>	Selects a surround decoder to be used in combination with the selected sound program.	<input checked="" type="checkbox"/> PLIIx Movie ( <input checked="" type="checkbox"/> PLII Movie), Neo:6 Cinema
<b>DSP Level</b>	Adjusts the sound field effect level.	-6dB ~ +3dB (default: 0dB) Higher to enhance the sound field effect and lower to reduce.
<b>Initial Delay</b>	Adjusts the delay between the direct sound and presence sound field generation.	1ms ~ 99ms Higher to enhance the delay effect and lower to reduce.
<b>Surround Initial Delay</b>	Adjusts the delay between the direct sound and surround sound field generation.	1ms ~ 49ms Higher to enhance the delay effect and lower to reduce.
<b>Surround Back Initial Delay</b>	Adjusts the delay between the direct sound and surround back sound field generation.	
<b>Room Size</b>	Adjusts the broadening effect of the presence sound field.	0.1 ~ 2.0
<b>Surround Room Size</b>	Adjusts the broadening effect of the surround sound field.	Higher to enhance the broadening effect and lower to reduce.
<b>Surround Back Room Size</b>	Adjusts the broadening effect of the surround back sound field.	
<b>Liveness</b>	Adjusts the loss of the presence sound field.	0 ~ 10
<b>Surround Liveness</b>	Adjusts the loss of the surround sound field.	Higher to enhance the reflectivity and lower to reduce.
<b>Surround Back Liveness</b>	Adjusts the loss of the surround back sound field.	
<b>Reverb Time</b>	Adjust the decay time of the rear reverberant sound.	1.0s ~ 5.0s Higher to enrich the reverberant sound and lower to have clear sound.

Item	Function	Settings
<b>Reverb Delay</b>	Adjusts the delay between the direct sound and rear reverberant sound generation.	0 ms ~ 250ms Higher to enhance the delay effect and lower to reduce.
<b>Reverb Level</b>	Adjusts the volume of the reverberant sound.	0% ~ 100% Higher to strengthen the reverberant sound and lower to weaken.

The following items are available when you select “2ch Stereo” or “7ch Stereo”.

Sound program	Item	Function	Settings
<b>2ch Stereo</b>	<b>Direct</b>	Selects whether to automatically bypass the DSP and tone control circuits when an analog audio source is played back.	Auto (default), Off Select “Auto” to bypass the circuits (when both “Treble” and “Bass” are set to “Bypass”).
	<b>Center Level</b>	Adjusts the volume of the center channel.	
	<b>Surround L Level</b>	Adjusts the volume of the surround left channel.	0% ~ 100% (default: 100%)
	<b>Surround R Level</b>	Adjusts the volume of the surround right channel.	
<b>7ch Stereo</b>	<b>Surround Back Level</b>	Adjusts the volume of the surround back channel.	0% ~ 100% (default: 50%)
	<b>Surround Back L Level</b>	Adjusts the volume of the surround back left channel.	0% ~ 100% (default: 35%)
	<b>Surround Back R Level</b>	Adjusts the volume of the surround back right channel.	
	<b>Front Presence L Level</b>	Adjusts the volume of the front presence left channel.	0% ~ 100% (default: 33%)
	<b>Front Presence R Level</b>	Adjusts the volume of the front presence right channel.	



- Available items in “7ch Stereo” vary depending on the speaker system being used.

## ■ Settings for decoders

The following items are available when you set "Decode Type" of "Surround Decoder" to "PLIIx Music" or "Neo:6 Music".

Decode Type	Item	Function	Settings
	<b>Panorama</b>	Adjusts the broadening effect of the front sound field.	Off (default), On Select "On" to wrap front right/left channel sounds around the field and generate a spacious sound field in combination with the surround sound field.
☑ <b>PLIIx Music</b>	<b>Center Width</b>	Adjusts the broadening effect of the center sound field.	0 ~ 7 (default: 3) Higher to enhance the broadening effect and lower to reduce (closer to center).
	<b>Dimension</b>	Adjusts the difference in level between the front and surround sound fields.	-3 ~ +3 (default: 0) Higher to strengthen the front sound field and lower to strengthen the surround sound field.
<b>Neo:6 Music</b>	<b>Center Image</b>	Adjusts the center orientation level (broadening effect) of the front sound field.	0.0 ~ 1.0 (default: 0.3) Higher to strengthen the center orientation level (less broadening effect) and lower to weaken (more broadening effect).

## Configuring various functions (Setup menu)

You can configure the various functions of this unit using the TV screen.

- 1 Press ON SCREEN.
- 2 Use the cursor keys to select “Setup” and press ENTER.

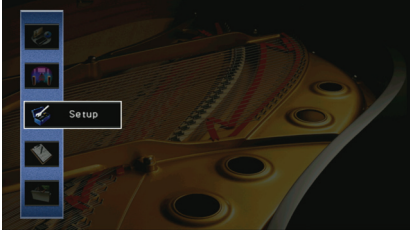

- 3 Use the cursor keys (◀/▶) to select a menu.



- 4 Use the cursor keys (△/▽) to select an item and press ENTER.



- To return to the previous screen during menu operations, press RETURN.

- 5 Use the cursor keys to select a setting and press ENTER.
- 6 To exit from the menu, press ON SCREEN.

## Setup menu items

Menu	Item	Function	Page		
Speaker	<b>Auto Setup</b>	Optimizes the speaker settings automatically (YPAO).	35		
	<b>Manual Setup</b>	<b>Power Amp Assign</b>	Selects a speaker system.	89	
		<b>Configuration</b>	<b>Front</b>	Selects the size of the front speakers.	89
			<b>Center</b>	Selects whether or not a center speaker is connected and its size.	89
			<b>Surround</b>	Selects whether or not surround speakers are connected and its size.	89
			<b>Surround Back</b>	Selects whether or not surround back speakers are connected and its size.	90
			<b>Front Presence</b>	Selects whether or not presence speakers are connected.	90
			<b>Subwoofer</b>	Selects whether or not a subwoofer is connected and its phase.	90
		<b>Extra Bass</b>	Sets the speakers to produce the front channel low-frequency components.	90	
		<b>Bass Cross Over</b>	Sets the lower limit of low-frequency component produced from speakers of which the size is set to "Small".	90	
		<b>Distance</b>	Sets the distance between each speaker and listening position.	90	
	<b>Level</b>	Adjusts the volume of each speaker.	91		
	<b>Parametric EQ</b>	<b>PEQ Select</b>	Selects a type of equalizer to be used.	91	
		<b>PEQ Data Copy</b>	Copies the parametric equalizer values acquired with "Auto Setup" to the "Manual" fields for fine adjustment.	91	
		<b>Test Tone</b>	Enables/disabled the test tone output.	91	
Sound	<b>Lipsync</b>	Adjusts the delay between video and audio output.	92		
	<b>Dynamic Range</b>	Selects the dynamic range adjustment method for bitstream audio (Dolby Digital and DTS signals) playback.	92		
	<b>Max Volume</b>	Sets the maximum volume so that sound is not too loud.	92		
	<b>Initial Volume</b>	Sets the initial volume for when this receiver is turned on.	92		
	<b>Adaptive DSP Level</b>	Selects whether to automatically adjust the CINEMA DSP effect level in conjunction with volume adjustments.	92		
Video	<b>Analog to Analog Conversion</b>	Enables/disables the video conversion between the analog video jacks.	93		
	<b>Processing</b>	Enables/disables the video signal processing (resolution and aspect ratio).	93		
HDMI	<b>HDMI Control</b>	Enables/disables HDMI Control. You can also configure the relevant settings (ARC, TV audio input, etc).	94		
	<b>Audio Output</b>	Selects a device to output audio.	95		
	<b>Standby Through</b>	Select whether to output videos/audio (input through HDMI jacks) to the TV when this unit is in standby mode.	95		
Network	<b>IP Address</b>	Configures the network parameters (IP address, etc).	95		
	<b>Network Standby</b>	Selects whether or not to turn on this unit by the command from other network devices.	96		
	<b>MAC Address Filter</b>	Sets the MAC address filter to limit access to this unit from other network devices.	96		

Menu	Item	Function	Page		
Multi Zone	Zone2 Set	Max Volume	Sets the Zone2 maximum volume so that sound is not too loud.	96	
		Initial Volume	Sets the Zone2 initial volume for when this unit is turned on.	96	
	Party Mode Set	Enables/disables switching to the party mode.	97		
	Zone Rename	Changes the zone names displayed on the TV screen.	97		
Function	Auto Power Down	Sets the amount of time for auto-standby.	97		
	Display Set	Front Panel Display	Dimmer	Adjusts the brightness of the front display.	97
		Scroll	Sets the scrolling manner of the front display.	97	
	Short Message	Selects whether to display short messages on the TV screen when this unit is operated.	98		
	Wall Paper	Selects a wall paper displayed on the TV.	98		
	Trigger Output	Trigger Mode	Specifies the condition for the TRIGGER OUT jack to function.	98	
		Target Zone	Specifies the zone with which the TRIGGER OUT jack functions synchronized.	98	
		Target Source	Specifies the output level of the electronic signal transmitted with each input switching.	98	
	Manual	Switches the output level for electronic signal transmission manually.	98		
	Memory Guard	Prevents accidental changes to the settings.	98		
Language	Select an on-screen menu language.	99			



## Speaker (Manual Setup)

Configures the speaker settings manually.

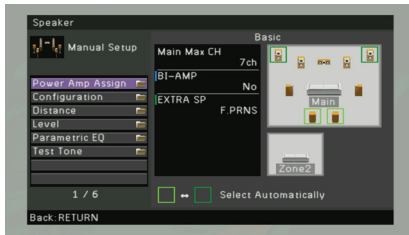

## Power Amp Assign

Selects a speaker system.

In addition to the 5.1- or 7.1-channel speaker system, various speaker configurations are possible using the presence speakers, Zone2 speakers or bi-amp connection.

### Settings

Basic (default)	Select this when you use a normal speaker system (not to use Zone2 speakers or bi-amp connection).
7ch+1ZONE	Select this when you use Zone2 speakers (p.67) in addition to the speaker system in the main zone.
5ch BI-AMP	Select this when you connect front speakers that support bi-amp connections (p.19).

## Configuration

Configures the output characteristics of the speakers.



- When you configure the speaker size, select "Large" if the woofer diameter of your speaker is 16 cm or larger or "small" if it is smaller than 16 cm.

### Front

Selects the size of the front speakers.

#### Settings

Large	Select this for large speakers. The front speakers will produce all of the front channel frequency components.
Small (default)	Select this for small speakers. The subwoofer will produce front channel low-frequency components (configurable in "Bass Cross Over").



- "Front" is automatically set to "Large" when "Subwoofer" is set to "None".

### Center

Selects whether or not a center speaker is connected and its size.

#### Settings

Large	Select this for large speaker. The center speaker will produce all of the center channel frequency components.
Small (default)	Select this for small speaker. The subwoofer will produce center channel low-frequency components (configurable in "Bass Cross Over").
None	Select this when no center speaker is connected. The front speakers will produce center channel audio.

### Surround

Selects whether or not surround speakers are connected and its size.

#### Settings

Large	Select this for large speakers. The surround speakers will produce all of the surround channel frequency components.
Small (default)	Select this for small speakers. The subwoofer will produce surround channel low-frequency components (configurable in "Bass Cross Over").
None	Select this when no surround speakers are connected. The front speakers will produce surround channel audio. Virtual CINEMA DSP works when you select a sound program.

## Surround Back

Selects whether or not surround back speakers are connected and its size.

### Settings

Large x1	Select this when 1 large speaker is connected. The surround back speaker will produce all of the surround back channel frequency components.
Large x2	Select this when 2 large speakers are connected. The surround back speakers will produce all of the surround back channel frequency components.
Small x1	Select this when 1 small speaker is connected. The subwoofer will produce surround back channel low-frequency components (configurable in "Bass Cross Over").
Small x2 (default)	Select this when 2 small speakers are connected. The subwoofer will produce surround back channel low-frequency components (configurable in "Bass Cross Over").
None	Select this when no surround back speakers are connected. The surround speakers and subwoofer (or front speakers) will produce surround back channel audio.

## Front Presence

Selects whether or not presence speakers are connected.

### Settings

Use (default)	Select this when presence speakers are connected.
None	Select this when no presence speakers are connected.

## Subwoofer

Selects whether or not subwoofer is connected and its phase.

### Settings

Use	Normal (default)	Select this when a subwoofer is connected (not to reverse the phase). The subwoofer will produce LFE (low-frequency effect) channel audio and low-frequency components from other channels.
	Reverse	Select this when a subwoofer is connected (reverse the phase). The subwoofer will produce LFE (low-frequency effect) channel audio and low-frequency components from other channels.
None		Select this when no subwoofer is connected. The front speakers will produce LFE (low-frequency effect) channel audio and low-frequency components from other channels.



- When the bass sound is lacking or unclear, switch the subwoofer phase.

## Extra Bass

Sets the speakers to produce the front channel low-frequency components.

### Settings

Off (default)	Depending on the size of the front speakers, either the subwoofer or front speakers produce the front channel low-frequency components.
On	Both the front speakers and subwoofer produce the front channel low-frequency components.



- This setting is not available when "Subwoofer" is set to "None" or "Front" is set to "Small".

## Bass Cross Over

Sets the lower limit of low-frequency component produced from speakers of which the size is set to "Small". A frequency sound lower than the specified value will be produced from the subwoofer or front speakers

### Settings

40Hz, 60Hz, 80Hz (default), 90Hz, 100Hz, 110Hz, 120Hz, 160Hz, 200Hz



- If the volume and cross-over frequency are adjustable on your subwoofer, set the volume to half and cross-over frequency to maximum.

## Distance

Sets the distance between each speaker and listening position so that sounds from the speakers reach the listening position at the same time. First, select the unit of distance from "Meter" or "Feet".

### Choices

Front L, Front R, Center, Surround L, Surround R, Surround Back L, Surround Back R, Front Presence L, Front Presence R, Subwoofer

### Setting range

0.30m ~ 24.00m (1.0ft ~ 80.0ft) \*0.05m (0.2ft) steps

### Default

3.00m (10.0ft)

## ■ Level

Adjusts the volume of each speaker.

### Choices

Front L, Front R, Center, Surround L, Surround R, Surround Back L, Surround Back R, Front Presence L, Front Presence R, Subwoofer

### Setting range

-10.0dB ~ +10.0dB (0.5dB steps)

### Default

0.0dB

## ■ Parametric EQ

Adjusts sound quality of tone with an equalizer.

### □ PEQ Select

Selects a type of equalizer to be used.

#### Settings

Manual	Select this when you want to adjust the equalizer manually. For details, see "Manual equalizer adjustment".
YPAO:Flat	Adjusts individual speakers to achieve the same characteristics.
YPAO:Front	Adjusts individual speakers to achieve the characteristics same as the front speakers.
YPAO:Natural	Adjusts all speakers to achieve a natural sound.
Through	Does not use the equalizer.



- "YPAO:Flat", "YPAO:Front" and "YPAO:Natural" are available only when the measurement results of "Auto Setup" have already been saved (p.35).

### □ PEQ Data Copy

Copies the parametric equalizer values acquired with "Auto Setup" (p.35) to the "Manual" fields for fine adjustment.

#### Choices

Flat > Manual	Copies the "Flat" values acquired with "Auto Setup".
Front > Manual	Copies the "Front" values acquired with "Auto Setup".
Natural > Manual	Copies the "Natural" values acquired with "Auto Setup".

## ■ Manual equalizer adjustment

- 1 Set "PEQ Select" to "Manual" and press ENTER.
- 2 Use the cursor keys to select a speaker and press ENTER.
- 3 Use the cursor keys to select an item and press ENTER.

**Band / Gain:** You can select a center frequency from the preset 7 bands and adjust the gain.

**Freq. / Gain:** You can adjust the center frequency of the selected band and adjust the gain.

**Q / Gain:** You can adjust the Q factor (bandwidth) of the selected band and adjust the gain.

**Clear:** Restores the default settings for the selected speaker.

- 4 Use the cursor keys to adjust parameters and press ENTER.

#### Setting range

Gain: -20.0dB ~ +6.0dB (0.5dB steps)

Center frequency: 31.3Hz ~ 16.0kHz

Q factor: 0.500 ~ 10.08

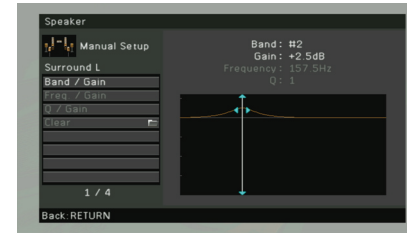

- 5 To exit from the menu, press ON SCREEN.

## ■ Test Tone

Enables/disables the test tone output. Test tone output helps you to adjust the speaker balance or equalizer while confirming its effect.

#### Settings

Off (default)	Does not output test tones.
On	Outputs test tones automatically when you adjust the speaker balance, equalizer, etc.

## Sound

Configures the audio output settings.



### ■ Lipsync

Adjusts the delay between video and audio output.

#### □ Auto

Adjusts the delay between video and audio output automatically when a TV that supports an automatic lipsync function is connected to this unit via HDMI. If necessary, you can fine-adjust the audio output timing. "Offset" shows the difference between automatic adjustment and fine adjustment.

##### Setting range

0ms ~ 250ms (1ms steps)

##### Default

0ms

#### □ Manual

Adjusts the delay between video and audio output manually.

##### Setting range

0ms ~ 250ms (1ms steps)

##### Default

0ms

### ■ Dynamic Range

Selects the dynamic range adjustment method for bitstream audio (Dolby Digital and DTS signals) playback.

#### Settings

Maximum (default)	Produces audio without adjusting the dynamic range.
Standard	Optimizes the dynamic range for regular home use.
Minimum/Auto	Sets the dynamic range to make clear sound even at night or at low volumes. When playing back Dolby TrueHD signals, the dynamic range is automatically adjusted based on the input signal information.

### ■ Max Volume

Sets the maximum volume so that sound is not too loud.

#### Setting range

-30.0dB ~ +15.0dB (5.0dB steps), +16.5dB

#### Default

+16.5dB

### ■ Initial Volume

Sets the initial volume for when this receiver is turned on.

#### Settings

Off (default)	Sets at the level when this unit last entered standby mode.
On	Sets at Mute, or -80.0dB ~ +16.5dB (0.5dB steps). (This setting works only when "Max Volume" is set higher.)

### ■ Adaptive DSP Level

Selects whether to automatically adjust the CINEMA DSP effect level in conjunction with volume adjustments.

#### Settings

Off	Does not adjust the effect level automatically.
On (default)	Adjusts the effect level automatically.

## Video

Configures the video output settings.

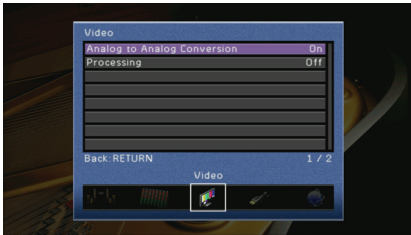

### ■ Analog to Analog Conversion

Enables/disables the video conversion (p.120) between the analog video jacks (COMPONENT VIDEO and VIDEO).

#### Settings

Off	Disables the video conversion between the analog video jacks.
On (default)	Enables the video conversion between the analog video jacks. Converted video signals are output from the MONITOR OUT jacks only.



- This unit does not convert 480-line and 576-line video signals interchangeably.
- 480p/576p-, 1080i- and 720p-resolution video signals cannot be output from the VIDEO jacks (p.120).

### ■ Processing

Enables/disables the video signal processing (resolution and aspect ratio).

#### Settings

Off (default)	Disables the video signal processing.
On	Enables the video signal processing. Select a resolution and an aspect ratio in "Resolution" and "Aspect".



- 720p-, 1080i- and 1080p-resolution video signals cannot be converted (p.120).

### □ Resolution

Selects a resolution to output HDMI video signals when "Processing" is set to "On".

#### Settings

Through	Does not convert the resolution.
Auto (default)	Selects a resolution automatically in accordance with TV resolution.
480p/576p, 720p, 1080i, 1080p	Output video signals with a selected resolution. (Only the resolutions supported by your TV are selectable.)



- If you need to select a resolution that is not supported by your TV, set "MON.CHK" (p.102) in the "ADVANCED SETUP" menu to "SKIP" and try again. (Note that output videos may not be displayed on your TV normally.)

### □ Aspect

Selects an aspect ratio to output HDMI video signals when "Processing" is set to "On".

#### Settings

Through (default)	Does not convert the aspect ratio.
16:9 Normal	Outputs 4:3 video signals to a 16:9 TV with black bands on either side of the screen.



- This setting functions only when 480i/576i or 480p/576p signals are converted into 720p, 1080i or 1080p signals.

# HDMI

Configures the settings related to HDMI.



## HDMI Control

Enables/disables HDMI Control (p. 121).

### Settings

Off (default)	Disables HDMI Control.
On	Enables HDMI Control. Configure the settings in "TV Audio Input", "ARC" and "Standby Sync".



- To use HDMI control, you need to perform the HDMI Control link setup (p. 121) after connecting HDMI Control-compatible devices.

## TV Audio Input

Selects an audio input jack of this unit to be used for TV audio input when "HDMI Control" is set to "On". The input source of this unit automatically switches to TV audio (input jack selected in here) when the TV input is switched to its built-in tuner.

### Settings

AV1~6, AUDIO1~2

### Default

AV4



- When using ARC to input TV audio to this unit, you cannot use the input jacks selected in here for connecting an external device because the input will be used for TV audio input.

## ARC

Enables/disables ARC (p.21) when "HDMI Control" is set to "On".

### Settings

Off	Disables ARC.
On (default)	Enables ARC.



- You do not need to change this setting normally. In case noises are produced from the speakers connected to this unit because TV audio signals input to this unit via ARC are not supported by this unit, set "ARC" to "Off" and use the TV speaker.

## Standby Sync

Select whether to set this unit to standby in conjunction with TV power-off when "HDMI Control" is set to "On".

### Settings

Off	Does not set this unit to standby mode in conjunction with TV power-off.
On	Sets this unit to standby mode in conjunction with TV power-off.
Auto (default)	Sets this unit to standby mode in conjunction with TV power-off only when this unit is receiving TV audio or HDMI signals.

## ■ Audio Output

Selects a device to output audio.



- The “Amp” and “HDMI OUT1” settings are available only when “HDMI Control” is set to “Off”.

### □ Amp

Enables/disables the audio output from the speakers connected to this unit.

#### Settings

Off	Disables the audio output from the speakers.
On (default)	Enables the audio output from the speakers.

### □ HDMI OUT1, HDMI OUT2

Enables/disables the audio output from a TV connected to the HDMI OUT 1 jack or HDMI OUT 2 jack.

#### Settings

Off (default)	Disables the audio output from the TV.
On	Enables the audio output from the TV.

## ■ Standby Through

Select whether to output videos/audio (input through HDMI jacks) to the TV when this unit is in standby mode.

#### Settings

Off (default)	Does not output videos/audio to the TV.
On	Outputs videos/audio to the TV. (This unit consumes approximately 3 W of power.)



- This setting is available only when “HDMI Control” is set to “Off”.

## Network

Configures the network settings.



### ■ IP Address

Configures the network parameters (IP address, etc).

### □ DHCP

Select whether to use a DHCP server.

#### Settings

Off	Does not use a DHCP server. Configure the network parameters manually.
On (default)	Uses a DHCP server to automatically obtain the network parameters (IP address, etc.) of this unit.

### □ Manual Setup

Configures the network parameters of this unit manually when “DHCP” is set to “Off”.

#### Submenu

IP Address	Specifies an IP address.
Subnet Mask	Specifies a subnet mask.
Default Gateway	Specifies the IP address of the default gateway.
DNS Server (P)	Specifies the IP address of the primary DNS server.
DNS Server (S)	Specifies the IP address of the secondary DNS server.

## ■ Network Standby

Selects whether to turn on this unit by the command from other network devices (network standby).

### Settings

Off (default)	Disables the network standby function.
On	Enables the network standby function. (This unit consumes approximately 5 W of power.)

## ■ MAC Address Filter

Sets the MAC address filter to limit access to this unit from other network devices.

### □ Mode

Enables/disables the MAC address filter.

### Settings

Off (default)	Disables the MAC address filter.
On	Enables the MAC address filter. In "Address Setup", specify the MAC addresses of the network devices that will be permitted access to this unit.

### □ Address Setup

Specifies the MAC addresses (up to 10) of the network devices that will be permitted access to this unit when "Mode" is set to "On".

## Multi Zone

Configures the multi zone settings.



## ■ Zone2 Set

Configures the audio output settings for Zone2.



- The "Zone2 Set" settings are available only when "Power Amp Assign" (p.89) is set to "7ch+1ZONE"

### □ Max Volume

Sets the Zone2 maximum volume so that sound is not too loud.

#### Setting range

-30.0dB ~ +15.0dB (5.0dB steps), +16.5dB

#### Default

+16.5dB

### □ Initial Volume

Sets the Zone2 initial volume for when this unit is turned on.

### Settings

Off (default)	Sets at the level when this unit last entered standby mode.
On	Sets at Mute, or -80.0dB ~ +16.5dB (0.5dB steps). (This setting works only when "Max Volume" is set higher.)



## Party Mode Set

Enables/disables switching to the party mode (p.70).

### Choice

Target: Zone 2

### Settings

Disable	Disables switching to the party mode.
Enable (default)	Enables switching to the party mode. You can turn on/off the party mode by pressing PARTY on the remote control.

## Zone Rename

Changes the zone names displayed on the TV screen.

### Setup procedure

- 1 Use the cursor keys to select a zone to be renamed and press ENTER.
- 2 Press ENTER, use the cursor keys to rename, and then press ENTER again.

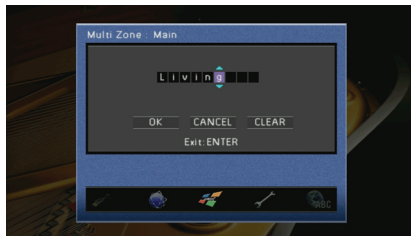

- 3 Use the cursor keys to select "OK" and press ENTER.



- To clear the entry, select "CLEAR".

- 4 To exit from the menu, press ON SCREEN.

## Function

Configures the functions that make this unit easier to use.



### Auto Power Down

Sets the amount of time for auto-standby. If you do not operate this unit for the specified time, this unit will automatically go into standby mode.

#### Settings

Off (default)	Does not set this unit to standby mode automatically.
4 Hours, 8 Hours, 12 Hours	Sets this unit to standby mode when you have not operated this unit for the specified time.

### Display Set

Configures the settings related to the front display and TV screen display.

#### Front Panel Display

Configures the front display settings.

#### Dimmer

Adjusts the brightness of the front display.

#### Setting range

-4 ~ 0 (higher to brighten)

#### Default

0

#### Scroll

Sets the scrolling manner of the front display.

The display scrolls automatically if the text exceeds 14 characters.

#### Settings

Continue (default)	Sets the display to scroll continuously.
Once	Sets the display to scroll all characters once and then halt scrolling for display of the first 14 characters.

## ❑ Short Message

Selects whether to display short messages on the TV screen when this unit is operated (input selection, volume adjustment, etc).

### Settings

On (default)	Displays short messages on the TV screen.
Off	Does not display short messages on the TV screen.

## ❑ Wall Paper

Selects a wall paper displayed on the TV.

### Settings

Picture1, Picture2, Picture3	Displays the selected image on the TV screen when there is no video signal.
Gray	Displays a gray background on the TV screen when there is no video signal.

## ■ Trigger Output

Sets the TRIGGER OUT jack to function synchronized with power status of each zone or input switching.

## ❑ Trigger Mode

Specifies the condition for the TRIGGER OUT jack to function.

### Settings

Power (default)	The TRIGGER OUT jack functions synchronized with the power status of the zone specified with "Target Zone."
Source	The TRIGGER OUT jack functions synchronized with the input switching in the zone specified with "Target Zone." Electronic signal is transmitted according to the setting made in "Target Source."
Manual	Select this to manually switch the output level for electronic signal transmission with "Manual."

## ❑ Target Zone

Specifies the zone with which the TRIGGER OUT jack functions synchronized.

### Settings

Main	When "Trigger Mode" is set to "Power," electronic signal transmission is synchronized with power status of the main zone. When "Trigger Mode" is set to "Source," electronic signal transmission is synchronized with input switching in the main zone.
------	--

Zone2	When "Trigger Mode" is set to "Power," electronic signal transmission is synchronized with power status of Zone2. When "Trigger Mode" is set to "Source," electronic signal transmission is synchronized with input switching in Zone2.
All (default)	When "Trigger Mode" is set to "Power," electronic signal transmission is synchronized with power status of the main zone or Zone2. When "Trigger Mode" is set to "Source," electronic signal transmission is synchronized with input switching in the main zone or Zone2.

## ❑ Target Source

Specifies the output level of the electronic signal transmitted with each input switching when "Trigger Mode" is set to "Source".

### Choices

HDMI1~7, AV1~6, V-AUX, AUDIO1~2, TUNER, PHONO, (network sources), USB, DOCK

### Settings

Low	Stops the electronic signal transmission when you switch to the input source specified in this option.
High (default)	Transmits the electronic signal when you switch to the input source specified in this option.

## ❑ Manual

Switches the output level for electronic signal transmission manually when "Trigger Mode" is set to "Manual". This setting can also be used to confirm proper function of the external component connected via the TRIGGER OUT jack.

### Choices

Low	Stops the electronic signal transmission.
High (default)	Transmits the electronic signal.

## ■ Memory Guard

Prevents accidental changes to the settings.

### Settings

Off (default)	Does not protect the settings.
On	Protects the settings until "Off" is selected.

## Language

Select an on-screen menu language.

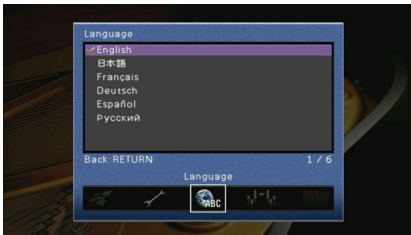

### Settings

English (default)	English
日本語	Japanese
Français	French
Deutsch	German
Español	Spanish
Русский	Russian



- The information on the front display is provided in English only.

## Viewing information about this unit (Information menu)

You can view information about this unit using the TV screen.

- 1 Press ON SCREEN.
- 2 Use the cursor keys to select “Information” and press ENTER.

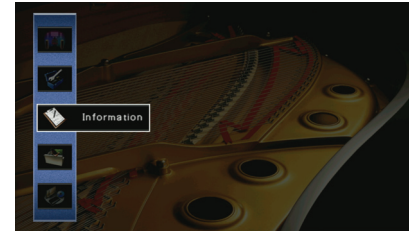

- 3 Use the cursor keys (</>) to select an information type.

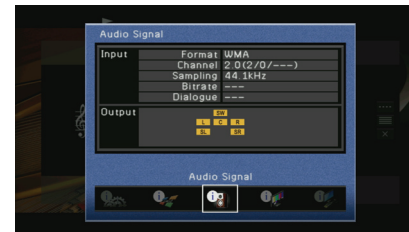

- 4 To exit from the menu, press ON SCREEN.

## Types of information

### ■ Audio Signal

Displays information about the current audio signal.

Input	Format	Audio format of the input signal
	Channel	The number of source channels in the input signal (front/surround/LFE) For example, "5.1 (3/2/0.1)" means 5.1ch in total (3 front channels, 2 surround channels, and LFE).
	Sampling	The number of samples per second of the input digital signal
	Bitrate	The amount of data per second of the input bitstream signal
	Dialogue	The dialogue normalization level of the input bitstream signal
Output	The speaker terminals from which signals are output	



- Even when this unit is set to output bitstream signals directly, the signal may be converted depending on the specifications and settings of the playback device.

### ■ Video Signal

Displays information about the current video signal.

HDMI Signal	Presence or absence of HDMI signal input/output
HDMI Resolution	Resolutions of input signal (analog or HDMI) and output signal (HDMI)
Analog Resolution	Resolutions of input signal (analog) and signal output at the MONITOR OUT jacks (analog)
HDMI Error	Errors related to HDMI HDCP Error: The TV does not support HDCP (High-bandwidth Digital Content Protection). Device Over: The number of devices connected to the HDMI OUT jack is over the limit.

### ■ HDMI Monitor

Displays information about the TVs connected to the HDMI OUT jacks. Use the cursor keys ( $\Delta/\nabla$ ) to switch between "OUT1" and "OUT2".

Interface	TV interface
Video Resolution	Resolutions supported by the TV

### ■ Network

Displays the network information on this unit.

IP Address	IP address
Subnet Mask	Subnet mask
Default Gateway	The IP address of the default gateway
DNS Server (P)	The IP address of the primary DNS server
DNS Server (S)	The IP address of the secondary DNS server
MAC Address	MAC address
Status	Network connection status

### ■ System

Displays the system information on this unit.

Remote ID	The remote control ID setting of the main unit (p.102)
TV Format	The video signal type setting of this unit (p.102)
Speaker Impedance	The speaker impedance setting of this unit (p.101)
System ID	System ID number
Firmware Version	The version of firmware installed on this unit



- If this unit detects a newer firmware over the network, "!" (exclamation mark) appears at the upper right of the "Information" and "System" icons, and the corresponding message will be displayed in this screen. You can update the firmware of this unit by pressing ENTER in this screen and following the procedure in "Updating the firmware of this unit" (p.108).

### ■ Zone

Displays information about Zone2.

Input	The input source selected for Zone2
Volume	The volume setting for Zone2

## Configuring the system settings (ADVANCED SETUP menu)

You can configure the system settings of this unit using the front display.

- 1 Set this unit to standby mode.
- 2 While holding down STRAIGHT on the front panel, press MAIN ZONE .

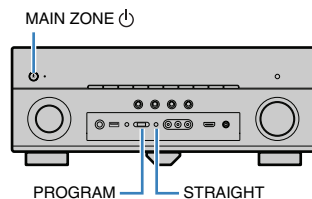

- 3 Press PROGRAM to select an item.
- 4 Press STRAIGHT to select a setting.
- 5 Press MAIN ZONE  to set this unit to standby mode and turn it on again.

The new settings become effective.

## ADVANCED SETUP menu items

Item	Function	Page
SP IMP.	Changes the speaker impedance setting.	101
REMOTE ID	Selects the remote control ID of the main unit.	102
TU	(Asia and General models only) Changes the frequency step setting.	102
TV FORMAT	Switches the video signal type.	102
MON.CHK	Removes the limitation on HDMI video output.	102
INIT	Restores the default settings.	103
UPDATE	Updates the firmware.	103
VERSION	Checks the version of firmware currently installed on this unit.	103

## Changing the speaker impedance setting (SP IMP.)

Change the speaker impedance settings of unit depending on the impedance of the speakers connected.

### Settings

6 Ω MIN	Select this when you connect 6-ohm speakers to this unit. You can also use 4-ohm speakers as the front speakers.
8 Ω MIN (default)	Select this when you connect 8-ohm or higher speakers to this unit.

## Selecting the remote control ID (REMOTE ID)

REMOTE ID - ID1

Select the remote control ID of the main unit so that it matches to the ID of the remote control (default: ID1). When using multiple Yamaha AV receivers, you can set each remote control with a unique remote control ID for its corresponding receiver.

### Settings

ID1 (default), ID2

### ■ Changing the remote control ID of the remote control

Perform each of the following steps within 1 minute. Otherwise, the setting will be automatically canceled.

- 1 Press **CODE SET** on the remote control using a pointed object such as the tip of a ballpoint pen.
- 2 Press **SOURCE/RECEIVER**.
- 3 Use the numeric keys to enter “5019” (ID1) or “5020” (ID2).

Once the remote control ID is registered successfully, SOURCE/RECEIVER blinks twice.

If it blinks 6 times, registration failed. Repeat from step 1.



- The registered remote control codes (p.104) are not cleared even if you change the remote control ID.

## Changing the frequency step setting (TU)

(Asia and General models only)

TU - FM50/AM9

Change the frequency step setting of this unit depending on your listening environment.

### Settings

FM100/AM10	Select this when you want to adjust the FM frequency by 100-kHz steps and AM by 10-kHz steps.
FM50/AM9 (default)	Select this when you want to adjust the FM frequency by 50-kHz steps and AM by 9-kHz steps.

## Switching the video signal type (TV FORMAT)

TV FORMAT - PAL

Switch the video signal type of this unit so that it matches to the format of your TV.

### Settings

NTSC, PAL

### Default

Korea and General models: NTSC

Other models: PAL

## Removing the limitation on HDMI video output (MON.CHK)

MON.CHK - YES

This unit automatically detects resolutions supported by a TV connected to the HDMI OUT jacks.

If you want to select a resolution in “Resolution” (p.93) regardless of the detection results or if this unit does not detect it correctly, disable the monitor check function.

### Settings

YES (default)	Enables the monitor check function. (Outputs video signals with a resolution supported by the TV only.)
SKIP	Disables the monitor check function. (Outputs video signals with a specified resolution regardless of compatibility with the TV.)



- In case this unit becomes inoperable because videos from this unit cannot be displayed on the TV after “MON.CHK” is set to “SKIP”, reset the setting to “YES”.

## Restoring the default settings (INIT)



Restores the default settings for the selected item.

### Choices

VIDEO	Restores the default settings for video configurations.
ALL	Restores the default settings for this unit.
CANCEL	Does not perform an initialization.

## Updating the firmware (UPDATE)

New firmware will be released irregularly for the purpose of additional features or product improvements. It can be downloaded from our website. If this unit is connected to the Internet, you can download the firmware via the network. For details, refer to the information supplied with updates.



### Firmware update procedure

Do not perform this procedure unless firmware update is necessary. Also, make sure you read the information supplied with updates before updating the firmware.

- 1 Press **STRAIGHT repeatedly** to select **“USB”** or **“NETWORK”** and press **INFO** to start firmware update.

### Choices

USB	Update the firmware using a USB memory device.
NETWORK	Update the firmware via the network.



- If this unit detects a newer firmware over the network, the corresponding message will be displayed after ON SCREEN is pressed. In this case, you can also update the firmware of this unit by following the procedure in “Updating the firmware of this unit” (p.108).

## Checking the firmware version (VERSION)

Check the version of firmware currently installed on this unit.



- You can also check the firmware version in “System” (p.100) in the “Information” menu.



## Controlling external devices with the remote control

By setting the code for external devices (BD/DVD players, etc.), you can operate it with the remote control of this unit.



- You cannot control an external device that does not have a remote control sensor.
- Make sure the remote control ID of the external device is set to "ID1". If any other ID is selected, the remote control operations may not work properly.
- If the remote control is without batteries for more than 2 minutes, the registered codes may be cleared. In this case, insert new batteries and setting the codes again.



- When HDMI control of both this unit and playback device such as a BD/DVD player are enabled, you may be able to control the device with the remote control without registering the remote control code.

## Setting the remote control code for a TV

By setting the remote control code for your TV, you can operate it with the remote control of this unit.



- You can also register a remote control code of your TV to the input selection keys (p.105). In this case, you can use the cursor keys or numeric keys to operate the TV depending on its model. However, you need to press the corresponding input selection key to play back TV audio on this unit.
- (China and Korea models only)  
You can also assign a function to each key using the learning function (p.106).

### 1 Use "Remote Control Code Search" in the CD-ROM to find a remote control code for your TV.



- If multiple remote control codes exist, first set the first code in the list, if it does not work then try the other codes.

### 2 Press CODE SET using a pointed object such as the tip of a ballpoint pen.

SOURCE/RECEIVER blinks twice.  
Perform each of the following steps within 1 minute.  
Otherwise, the setting will be canceled. In this case, repeat from step 2.

### 3 Press TV ⏻

### 4 Use the numeric keys to enter the 4-digit remote control code.

Once the remote control code is set successfully, SOURCE/RECEIVER blinks twice.  
If it blinks 6 times, registration failed. Repeat from step 2.

## TV operations

Once you have set the remote control code for your TV, you can control it using the TV operation keys regardless of an input source selected on this unit.

TV operation keys	INPUT	Switches the video inputs of the TV.
	MUTE	Mutes the audio output of the TV.
	TV VOL	Adjust the volume of the TV.
	TV CH	Switch the channels of the TV
	TV ⏻	Turns on/off the TV.



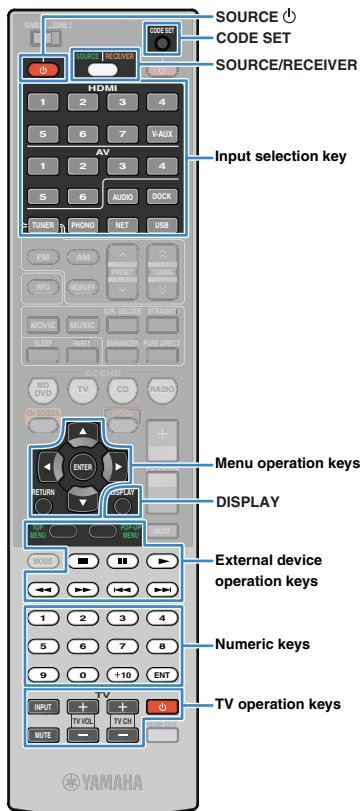

## Setting the remote control codes for playback devices

By setting the remote control codes for your playback devices, you can operate those devices with the remote control of this unit. Since the codes are assigned to each input source key, you can select the input source and device to control with the remote control concurrently.



- At the factory, Yamaha CD player code (5095) is set for AV3. For the other input selection keys, no codes are set.
- (China and Korea models only)  
You can also assign a function to each key using the learning function (p.106).

### 1 Use “Remote Control Code Search” in the CD-ROM to find a remote control code for your playback device.



- If multiple remote control codes exist, first set the first code in the list, if it does not work then try the other codes.

### 2 Press CODE SET using a pointed object such as the tip of a ballpoint pen.

SOURCE/RECEIVER blinks twice.  
Perform each of the following steps within 1 minute.  
Otherwise, the setting will be canceled. In this case, repeat from step 2.

### 3 Press a corresponding input selection key.

For example, press HDMI1 to set the remote control code for the playback device connected to the HDMI1 jack.

### 4 Use the numeric keys to enter the 4-digit remote control code.

Once the remote control code is registered successfully, SOURCE/RECEIVER blinks twice.  
If it blinks 6 times, registration failed. Repeat from step 2.



- For details on how to register the input selection key applied the remote control code on a corresponding SCENE key, refer to “Configuring scene assignments” (p.43).

## Playback device operations

Once you have registered the remote control code for your playback device, you can control it using the following keys after selecting the input source or scene.



- By pressing SOURCE/RECEIVER, you can switch the devices (this unit or external device) to operate with the menu operation keys, DISPLAY and numeric keys. You can operate this unit when SOURCE/RECEIVER lights up in orange, and an external device when SOURCE/RECEIVER lights up in green.  
For example, if you register the remote control code of your external device on TUNER, you can operate FM/AM radio built in this unit when SOURCE/RECEIVER lights up in orange, and the external device when SOURCE/RECEIVER lights up in green.

SOURCE (power icon)		Turns on/off the playback device.
Menu operation keys	Cursor keys	Select an item.
	ENTER	Confirms a selected item.
	RETURN	Returns to the previous screen.
DISPLAY		Switches information on the display.
External device operation keys	TOP MENU	Displays the top menu.
	POP-UP MENU	Displays the pop-up menu.
		Stops playback.
		Stops playback temporarily.
		Starts playback of the selected song/video.
External device operation keys		Search forward/backward (by holding down).
		Search forward/backward (by holding down).
		Skip forward/backward.
Numeric keys		Enter numerical values.
TV operation keys		Control the TV (p.104).



- These keys work only when the corresponding function is available on your playback device and is possible to be operated with an infrared remote control.

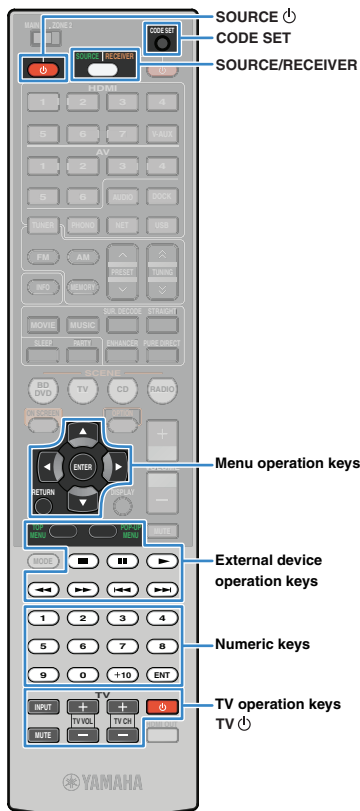

## Programming from other remote controls (learning)

(China and Korea models only)

The remote control of this unit can receive remote control signals from other remote controls and learn the remote control operation. If you cannot find a remote control code for your playback device or if any key on the remote control does not work after you set the remote control code, use the learning function to assign a function to each key.

### 1 Press CODE SET using a pointed object such as the tip of a ballpoint pen.

SOURCE/RECEIVER blinks twice.

Perform each of the following steps within 1 minute.

Otherwise, the setting will be canceled. In this case, repeat from step 1.

### 2 Press one of the following keys depending on the type of your device.

**For playback device:** press the input selection key (corresponding to the input jacks where the device is connected).

**For TV:** press TV  $\downarrow$ .

### 3 Use the numeric keys to enter "9990".

### 4 Aim the infrared transmitters of the remote controls at each other.

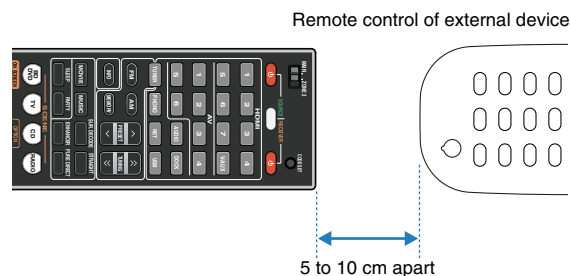

### 5 Perform the following steps within 10 seconds.

- ① On this unit, press one of the following keys to which you want to assign a function.

**For playback device:** SOURCE  $\downarrow$ , menu operations keys, external device operation keys

**For TV:** TV operation keys

- ② On the external device, press the key from which the operation is learned.

Once the operation is learned successfully, SOURCE/RECEIVER blinks twice.

If it blinks 6 times, learning failed. Repeat step 5.

### 6 Repeat step 5 until all desired operations are learned.

### 7 Press CODE SET using a pointed object such as the tip of a ballpoint pen.

SOURCE/RECEIVER blinks once.

#### Note

- If you press SOURCE/RECEIVER in step 2, you can assign functions of an external receiver to the menu operation keys, external device operation keys or numeric keys. However, it makes these keys to control this unit impossible. If you need to restore the remote control code for this unit, perform the following steps.

- ① Press CODE SET using a pointed object such as the tip of a ballpoint pen.
- ② Press SOURCE/RECEIVER.
- ③ Use the numeric keys to enter "9992".



## Resetting remote control codes

### ■ Resetting all remote control codes

You can clear all remote control codes (including functions learned from other remote controls [China and Korea models only]) and restore the default settings.



- The settings for controlling playback devices after selecting a scene (p.43) will be also cleared.

#### 1 Press CODE SET using a pointed object such as the tip of a ballpoint pen.

SOURCE/RECEIVER blinks twice.

Perform each of the following steps within 1 minute.

Otherwise, the setting will be canceled. In this case, repeat from step 1.

#### 2 Press SOURCE/RECEIVER.

#### 3 Use the numeric keys to enter “9981”.

Once the remote control codes are reset successfully, SOURCE/RECEIVER blinks twice.

If it blinks 6 times, resetting failed. Repeat from step 1.

### ■ Clearing functions learned from other remote controls (China and Korea models only)

#### □ Clearing the assignment of each key

#### 1 Press CODE SET using a pointed object such as the tip of a ballpoint pen.

SOURCE/RECEIVER blinks twice.

Perform each of the following steps within 1 minute.

Otherwise, the setting will be canceled. In this case, repeat from step 1.

#### 2 Press one of the following keys to select the device for which key assignments will be cleared.

**For playback device:** press the input selection key.

**For TV:** press TV ⏻.

#### 3 Use the numeric keys to enter “9991”.

#### 4 Press the key that you want to reset.

Once the key assignment is cleared successfully, SOURCE/RECEIVER blinks twice.

If it blinks 6 times, clearing failed. Repeat from step 2.

#### 5 Repeat step 4 until all desired key assignments are cleared.

#### 6 Press CODE SET using a pointed object such as the tip of a ballpoint pen.

SOURCE/RECEIVER blinks once.

#### □ Clearing the key assignments for each input source

#### 1 Press CODE SET using a pointed object such as the tip of a ballpoint pen.

SOURCE/RECEIVER blinks twice.

Perform each of the following steps within 1 minute.

Otherwise, the setting will be canceled. In this case, repeat from step 1.

#### 2 Press one of the following keys to select the device for which key assignments will be cleared.

**For playback device:** press the input selection key.

**For TV:** press TV ⏻.

#### 3 Use the numeric keys to enter “9992”.

Once the key assignment is cleared successfully, SOURCE/RECEIVER blinks twice.

If it blinks 6 times, clearing failed. Repeat from step 1.



Cursor keys  
ENTER

## Updating the firmware of this unit

If this unit is connected to the Internet, the corresponding message will be displayed on the TV when a newer firmware is available. In this case, follow the procedure below to update the firmware of this unit.

### Note

- Do not operate this unit or disconnect the power cable or network cable during firmware update. Firmware update takes about 15 minutes.



- You can also update the firmware using the USB memory device from the "ADVANCED SETUP" menu (p.103).

If the following message is displayed after ON SCREEN is pressed, firmware update is available.

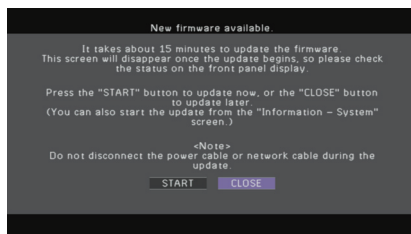

- Read the on-screen description.
- To start the firmware update, use the cursor keys to select "START" and press ENTER.

The on-screen display turns off.

- If "UPDATE SUCCESS PLEASE POWER OFF!" appears on the front display, press MAIN ZONE  on the front panel.

The firmware update is complete.



- If you want to update the firmware later, select "CLOSE" in step 2. In this case, "!" (exclamation mark) appears at the upper right of the "Information" and "System" icons, and the corresponding message will be displayed in the "System" screen (p.100). You can update the firmware of this unit by pressing ENTER in the "System" screen.

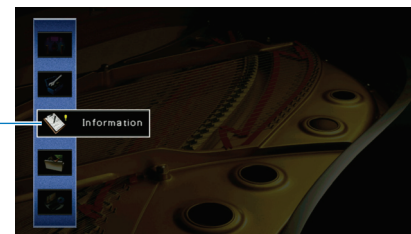

Information icon

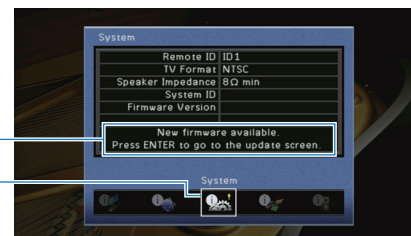

Message

System icon

# APPENDIX

## Frequently asked questions

### **The new speaker system does not provide an ideal sound balance...**

If you have changed speakers or speaker system, use "Auto Setup" to optimize the speaker settings again (p.35). If you want to adjust the speaker settings manually, use "Manual Setup" in the "Setup" menu (p.89).

### **Since we have small children, we want to set limitations on the volume control...**

If a small child, etc. accidentally operates the controls on the main unit or remote control, the volume may suddenly increase. And this may cause injury or damage this unit or speakers. We recommend using "Max Volume" in the "Setup" menu to set the maximum volume level for this unit in advance (p.92). You can also set the maximum volume for Zone2 (p.96).

### **I am occasionally startled by a sudden large sound when turning on this unit...**

By default, the volume level when this unit last entered standby mode is automatically applied. If you want to fix the volume, use "Initial Volume" to set the volume to be applied when this receiver is turned on (p.92). You can also set the initial volume for Zone2 (p.96).

### **I made HDMI connections but HDMI Control does not work at all...**

To use HDMI Control, you need to perform the HDMI Control link setup (p.121). After connecting HDMI Control-compatible devices (TV, BD/DVD players, etc.) to this unit, enable HDMI Control on each device and perform the HDMI Control link setup. This setup is required every time when you add a new HDMI Control-compatible device to your system. For information on how HDMI Control works between your TV and playback devices, refer to the instruction manuals of each device.

### **I want to turn off the onscreen messages displayed during operations...**

By default, short messages are displayed on the TV screen when this unit is operated (input selection, volume adjustment, etc). In case that the short messages bother you when you are watching movies or sports, configure "Short Message" (p.98) in the "Setup" menu to turn off the short messages.

### **I want to prevent accidental changes to the settings...**

You can protect the settings configured on this unit (speaker settings, etc.) by utilizing "Memory Guard" in the "Setup" menu (p.98).

### **The web control screen (p.72) becomes inaccessible...**

If you are using a DHCP server, the IP address of this unit may change each time this unit is turned on. Check the IP address of this unit in "Network" (p.100) in the "Information" menu. Also, if you have enabled "MAC Address Filter" (p.96), you need to specify the MAC address of your PC in "Address Setup" (p.96) to allow the PC to access this unit. For information on how to check the MAC address of your PC, refer to the instruction manuals of it.

### **The supplied remote control concurrently controls this unit and another Yamaha product that is not intended...**

When using multiple Yamaha products, the supplied remote control may work on another Yamaha product or another remote control may work on this unit. In this case, set each remote control with a unique remote control ID for its corresponding receiver (p.102).

## Troubleshooting



Refer to the table below when this unit does not function properly.

If the problem you are experiencing is not listed below, or if the instructions below do not help, turn off this unit, disconnect the power cable, and contact the nearest authorized Yamaha dealer or service center.

### First, check the followings:

- ① **The power cables of this unit, TV and playback devices (BD/DVD player, etc.) are connected to AC outlets securely.**
- ② **This unit, subwoofer, TV and playback devices (BD/DVD player, etc.) are turned on.**
- ③ **The connectors of each cable are inserted to jacks on each devices securely.**

### Power and system

Problem	Cause	Remedy
<b>The power does not turn on.</b>	The protection circuitry has been activated 3 times consecutively.	As a safety precaution, capability to turn on the power is disabled. Contact your nearest Yamaha dealer or service center to request repair.
<b>The power does not turn off.</b>	The internal microcomputer is hung-up due to an external electric shock (such as lightning and excessive static electricity) or by a drop in power supply voltage.	Hold down MAIN ZONE  on the front panel for more than 10 seconds to initialize and reboot this unit.
<b>The power turns off (standby mode) immediately.</b>	This unit was turned on while a speaker cable was shorted.	Twist the bare wires of each speaker cable firmly and reconnect to this unit and speakers (p.19).
<b>The unit enters standby mode automatically.</b>	The sleep timer worked.	Turn on the unit and start playback again.
	Since this unit was not operated for the specified time, auto-standby worked.	To disable auto-standby, set "Auto Power Down" in the "Setup" menu to "Off" (p.97).
	The speaker impedance setting is incorrect.	Set the speaker impedance to match your speakers (p.101).
	The protection circuitry has been activated because of a short circuit.	Twist the bare wires of each speaker cable firmly and reconnect to this unit and speakers (p.19).
<b>This unit is uncontrollable.</b>	The internal microcomputer is hung-up due to an external electric shock (such as lightning and excessive static electricity) or by a drop in power supply voltage.	Hold down MAIN ZONE  on the front panel for more than 10 seconds to initialize and reboot this unit.

## Audio

Problem	Cause	Remedy
<b>No sound.</b>	Another input source is selected.	Select an appropriate input source with the input selection keys
	Signals that this unit cannot reproduce are being input.	Some digital audio formats cannot be played back on this unit. To check the audio format of the input signal, use "Audio Signal" in the "Information" menu (p.100).
	The cable connecting this unit and playback device is defective.	If there is no problem with the connection, replace with another cable.
<b>The volume cannot be increased.</b>	The maximum volume is set.	Use "Max Volume" in the "Setup" menu to adjust the maximum volume (p.92).
	Any device connected to the output jacks of this unit is not turned on. (This may happen due to the nature of AV receivers.)	Turn on all devices connected to the output jacks of this unit
<b>No sound is heard from a specific speaker.</b>	The playback source does not contain corresponding channel signals.	To check it, select "7ch Stereo" (p.44).
	The sound program/decoder currently selected does not use the corresponding speaker.	To check it, select "7ch Stereo" (p.44).
	Audio output of the corresponding speaker is disabled.	Perform "Auto Setup" (p.35) or use "Configuration" in the "Setup" menu to change the speaker setting (p.89).
	The volume of the corresponding speaker is too low.	Perform "Auto Setup" (p.35) or use "Level" in the "Setup" menu to adjust the speaker volume (p.91).
	The speaker cable connecting this unit and corresponding speaker is defective.	If there is no problem with the connection, replace with another speaker cable.
	The corresponding speaker is malfunctioning.	To check it, replacing with another speaker. If the problem persists, this unit may be malfunctioning.
<b>No sound is heard from the surround back speaker.</b>	The extended surround is disabled.	Use "Extended Surround" in the "Option" menu to select a decoder to be used (p.77).
<b>No sound is heard from the subwoofer.</b>	The playback source does not contain LFE or low-frequency signals.	To check it, set "Extra Bass" in the "Setup" menu to "On", to output the front channel low-frequency components from the subwoofer (p.90).
	Subwoofer output is disabled.	Perform "Auto Setup" (p.35) or set "Subwoofer" in the "Setup" menu to "Use" (p.90).
	The subwoofer is turned off by the auto-standby function on it.	Disable the auto-standby function of the subwoofer or adjust its sensitivity level.
<b>No sound from the playback device (connected to this unit with HDMI).</b>	The TV does not support HDCP (High-bandwidth Digital Content Protection).	To check it, use "Video Signal" in the "Information" menu (p.100).
	This unit is set not to output audio input through HDMI jacks from the SPEAKERS terminals.	In "Audio Output" in the "Setup" menu, set "Amp" to "On" (p.95).
	The number of devices connected to the HDMI OUT jack is over the limit.	Disconnect some of the HDMI devices.

Problem	Cause	Remedy
<b>No sound from the TV (when HDMI Control is used).</b>	(If the TV is connected to this unit with an audio cable) The TV audio input setting does not match the actual connection.	Use "TV Audio Input" in the "Setup" menu to select the correct audio input jack (p.94).
	(If you are trying to use ARC) ARC is disabled on this unit or TV.	Set "ARC" in the "Setup" menu to "On" (p.94). Also, enable ARC on the TV.
<b>Only the front speakers work on multi-channel audio.</b>	The playback device is set to output 2-channel audio (PCM, etc.) only.	Change the digital audio output setting on the playback device.
<b>Noise/hum is heard.</b>	This unit is too close to other digital or radio frequency device.	Move this unit further away from such device.
	The cable connecting this unit and playback device is defective.	If there is no problem with the connection, replace with another cable.
<b>The sound is distorted.</b>	Any device connected to the output jacks of this unit is not turned on. (This may happen due to the nature of AV receivers.)	Turn on all devices connected to the output jacks of this unit

## Video

Problem	Cause	Remedy
<b>No video.</b>	Another input source is selected on this unit.	Select an appropriate input source with the input selection keys
	Another input source is selected on the TV.	Switch the TV input to display the video from this unit.
	The video signal output from this unit is not supported by the TV.	Set "MON.CHK" in the "ADVANCED SETUP" menu to "YES" (p.102).
	The cable connecting this unit and TV (or playback device) is defective.	If there is no problem with the connection, replace with another cable.
<b>No video from the playback device (connected to this unit with HDMI).</b>	The input video signal (resolution) is not supported by this unit.	To check the information about the current video signal (resolution), use "Video Signal" in the "Information" menu (p.100). For information about video signals supported by this unit, see "HDMI signal compatibility" (p.122).
	The TV does not support HDCP (High-bandwidth Digital Content Protection).	To check it, use "Video Signal" in the "Information" menu (p.100).
	The number of devices connected to the HDMI OUT jack is over the limit.	Disconnect some of the HDMI devices.



## FM/AM radio

Problem	Cause	Remedy
<b>FM radio reception is weak or noisy.</b>	There is multi-path interference.	Adjust the FM antenna height or orientation, or place it in a different location.
	Your area is too far from the FM station transmitter.	Press MODE to select monaural FM radio reception (p.49). Use an outdoor FM antenna commercially available. We recommend using a sensitive multi-element antenna.
<b>AM radio reception is weak or noisy.</b>	The noises may be caused by fluorescent lamps, motors, thermostats, or other electrical equipment.	It is difficult to completely eliminate noise. It may be reduced by using an outdoor AM antenna commercially available.
<b>Radio stations cannot be selected automatically.</b>	Your area is too far from the FM station transmitter.	Select the station manually (p.49).
		Use an outdoor antenna commercially available. We recommend using a sensitive multi-element antenna.
	The AM radio signal is weak.	Adjust the AM antenna orientation.
		Select the station manually (p.49). Use an outdoor AM antenna commercially available. Connect it to the ANTENNA (AM) jack together with the supplied AM antenna.
<b>AM radio stations cannot be registered as presets.</b>	"Auto Preset" has been used.	"Auto Preset" is for registering FM radio stations only. Register AM radio stations manually (p.50).

## USB and network

Problem	Cause	Remedy
<b>This unit does not detect the USB device.</b>	The USB cable connecting this unit and USB device is not compliant with USB 2.0.	Use a USB cable compliant with USB 2.0.
<b>Folders and files in the USB device cannot be viewed.</b>	The folder structure not supported by this unit is applied.	This unit supports folder hierarchies of up to 8 levels and up to 500 items (total of files and subfolders) per folder. If necessary, modify the folder structure on your USB device.
<b>The network feature does not function.</b>	The network parameters (IP address) is not obtained properly.	Enable the DHCP server function on your router and set "DHCP" in the "Setup" menu to "On" on this unit (p.95). If you want to configure the network parameters manually, make sure using an IP address which is not used by other network devices in your network (p.95).
<b>This unit does not detect the PC.</b>	The media sharing setting is not correct.	Configure the sharing setting and select this unit as a device to which music contents are shared (p.62).
	Some security software installed on your PC is blocking the access of this unit to your PC.	Check the settings of security software installed on your PC.
	This unit and PC are not in the same network.	Check the network connections and the settings of your router to connect them to the same network.

Problem	Cause	Remedy
<b>The files in the PC cannot be viewed or played back.</b>	The files are not supported by this unit or the media server.	Use the file format supported by both this unit and the media server. For information about the file formats supported by this unit, see "Playing back music stored on PCs" (p.62).
<b>The Internet radio cannot be played.</b>	The selected Internet radio station is currently not available.	It may not be available to listen because there might be a network problem, or the station might be broadcasting in limited hour. Try the station later or select another station.
	The selected Internet radio station broadcasts audio silence currently.	Some Internet radio stations broadcast audio silence during particular periods of time in a day. Try the station later or select another station.
	Access to the network is restricted by the firewall settings of your network devices (router, etc).	Check the firewall settings of your network devices. The Internet radio can be played only when it passes through the port designated by each radio station. The port number is variable depending on radio station.

## Remote control

Problem	Cause	Remedy
<b>This unit cannot be controlled using the remote control.</b>	Out of the operating range.	Use the remote control in the operating range (p.5).
	The batteries are weak.	Replace with new batteries.
	Direct sunlight or lighting is striking the remote control sensor of this unit.	Adjust the lighting angle, or reposition this unit.
	The remote control is set to control external devices.	Press SOURCE/RECEIVER to set the remote control to control this unit (the key lights up in orange).
	The remote control IDs of the main unit and remote control are not identical.	Change the remote control ID of the main unit or remote control (p.102).
<b>External devices cannot be controlled using the remote control.</b>	The remote control is set to control this unit.	Press SOURCE/RECEIVER to set the remote control to control external devices (the key lights up in green).
	The corresponding remote control code is not set properly.	Set the remote control code again (p.104). Even if the remote control code is registered properly set, some products may not respond to the remote control.
<b>The remote control does not learn new functions. (China and Korea models only)</b>	The batteries of the remote control of this unit and/or the external device are weak.	Replace with new batteries.
	The distance between the two remote controls is not appropriate.	Place the remote controls at a proper distance (p.106).
	The signal coding or modulation of the other remote control is not compatible with this remote control.	Learning is impossible in this case.
	Memory capacity is full.	Clear unnecessary assignments to free some memory space for the new functions (p.107).

## Error indications on the front display

Message (alphabetical order)	Cause	Remedy
<b>Access denied</b>	Access to the PC is denied.	Configure the sharing setting and select this unit as a device to which music contents are shared (p.62).
<b>Access error</b>	This unit cannot access the USB device.	Turn off this unit and reconnect your USB device. If the problem persists, try another USB device.
	This unit cannot access the iPod connected to the USB jack.	Turn off the iPod and turn on it again.
	There is a problem with the signal path from the network to this unit.	Make sure your router and modem are turned on. Check the connection between this unit and your router (or hub) (p.30).
<b>No device</b>	This unit cannot detect the USB device.	Turn off this unit and reconnect your USB device. If the problem persists, try another USB device.
	This unit cannot detect the iPod connected to the USB jack.	Turn off the iPod and turn on it again.
<b>Not found</b>	The Bluetooth component is not found.	(When pairing) Turn on the Bluetooth component and set it in pairing mode.
		(When establishing a wireless connection) - Turn on the Bluetooth component. - Place the Bluetooth component within 10 m of the Bluetooth receiver. - Perform pairing again.
<b>Unknown iPod</b>	The connected iPod is not supported by the unit.	Use an iPod supported by this unit (p.52).
<b>Unable to play</b>	The unit cannot play back the songs stored on the iPod for some reasons.	Check the song data. If it cannot be played on the iPod itself, the song data or storage area may be defective.
	The unit cannot play back the songs stored on the PC for some reasons.	Check if the format of files you are trying to play is supported by this unit. For information about the formats supported by this unit, see "Playing back music stored on PCs" (p.62). If this unit cannot play back any files, the network may be overloaded with heavy traffic, and playback is interrupted.
<b>USB Overloaded</b>	Over current passes through the USB device.	Turn off this unit and reconnect your USB device. If the problem persists, try another USB device.

## Ideal speaker layout

Use this diagram as guide. You do not need to adjust the speaker layout to the following diagram exactly.

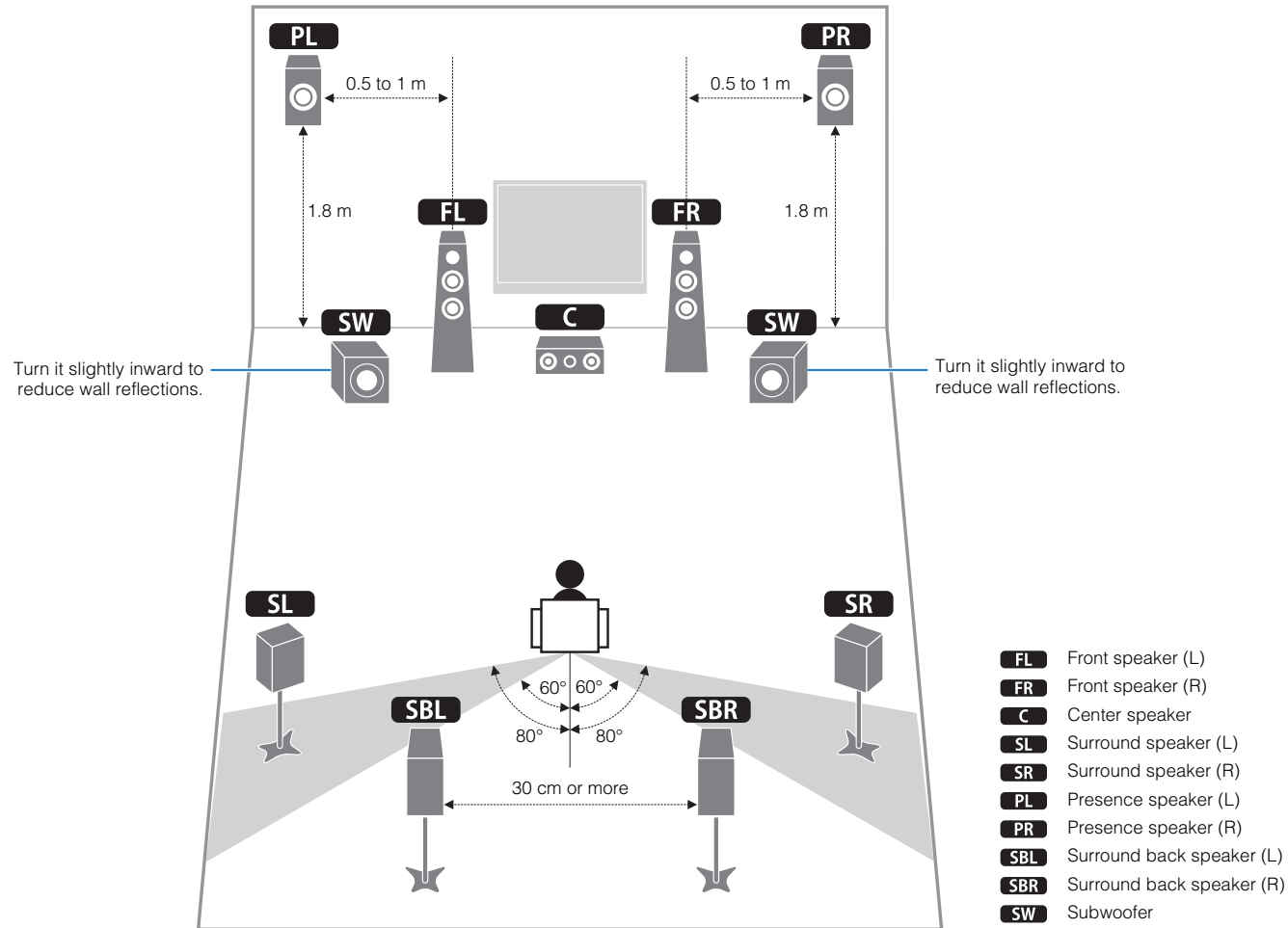

## Audio information

### Audio and video synchronization (Lipsync)

Lip sync, an abbreviation for lip synchronization, is a technical term that involves both a problem, and the capability of maintaining audio and video signals synchronized during post-production and transmission.

Whereas the audio and video latency requires complex end-user adjustment, HDMI version 1.3 incorporates an automatic audio and video syncing capability that allows devices to perform this synchronization automatically and accurately without user interaction.

### Bi-amplification connection (Bi-amp)

A bi-amplification connection uses two amplifiers for a speaker. One amplifier is connected to the woofer section of a loudspeaker while the other is connected to the combined mid and tweeter section. With this arrangement each amplifier operates over a restricted frequency range. This restricted range presents each amplifier with a much simpler job and each amplifier is less likely to influence the sound in some way.

### CINEMA DSP

Since the Dolby Surround and DTS systems were originally designed for use in movie theaters, their effect is best felt in a theater having many speakers designed for acoustic effects. Since home conditions, such as room size, wall material, number of speakers, and so on, can differ so widely, it is inevitable that there are differences in the sound that is heard. Based on a wealth of actually measured data, Yamaha CINEMA DSP uses Yamaha's original DSP technology to combine Dolby Pro Logic, Dolby Digital, and DTS systems to provide the audiovisual experience of a movie theater in the listening room of your own home.

### CINEMA DSP 3D

The actually measured sound field data contain the information of the height of the sound images. CINEMA DSP 3D feature achieves the reproduction of the accurate height of the sound images so that it creates the accurate and intensive stereoscopic sound fields in a listening room.

### Compressed Music Enhancer

The Compressed Music Enhancer feature of this unit enhances your listening experience by regenerating the missing harmonics in compression artifacts. As a result, it compensates for flattened complexity due to the loss of high-frequency fidelity as well as lack of bass due to the loss of low-frequency bass, providing improved performance for the overall sound system.

### Dolby Digital

Dolby Digital is a digital surround sound system that gives you completely independent multi-channel audio. With 3 front channels (front L/R and center), and 2 surround stereo channels, Dolby Digital provides 5 full-range audio channels. With an additional channel especially for bass effects, referred to as LFE (Low-Frequency Effect), the system has a total of 5.1-channels (LFE is counted as 0.1 channel). By using 2-channel stereo for the surround speakers, more accurate moving sound effects and surround sound environments are possible than with Dolby Surround. The wide dynamic range from maximum to minimum volumes that are reproduced by the 5 full-range channels, and the precise sound orientation generated using digital sound processing provides listeners with unprecedented excitement and realism. With this unit, any sound environment from monaural up to a 5.1-channel configuration can be freely selected for your enjoyment.

### Dolby Digital Plus

Dolby Digital Plus is an advanced audio technology developed for highdefinition programming and BD (Blu-ray disc). Selected as an optional audio standard for BD, this technology delivers multichannel sound with discrete channel output. Supporting bitrates up to 6.0 Mbps, Dolby Digital Plus can carry up to 7.1 discrete audio channels simultaneously. Supported by HDMI version 1.3 and designed for the optical disc players and AV receivers/amplifiers of the future, Dolby Digital Plus also remains fully compatible with the existing multichannel audio systems that incorporate Dolby Digital.

### Dolby Pro Logic II

Dolby Pro Logic II is an improved technique used to decode vast numbers of existing Dolby Surround sources. This new technology enables a discrete 5-channel playback with 2 front left and right channels, 1 center channel, and 2 surround left and right channels, instead of only 1 surround channel for conventional Pro Logic technology. There are three modes available: "Music mode" for music sources, "Movie mode" for movie sources, and "Game mode" for game sources.

### Dolby Pro Logic IIx

Dolby Pro Logic IIx is a new technology enabling discrete multichannel playback from 2-channel or multi-channel sources. There are three modes available: "Music mode" for music sources, "Movie mode" for movie sources (for 2-channel sources only) and "Game mode" for game sources.

### Dolby Surround

Dolby Surround uses a 4-channel analog recording system to reproduce realistic and dynamic sound effects: 2 front left and right channels (stereo), a center channel for dialog (monaural), and a surround channel for special sound effects (monaural). The surround channel reproduces sound within a narrow frequency range. Dolby Surround is widely used with nearly all video tapes and laser discs, as well as in many TV and cable broadcasts. The Dolby Pro Logic decoder built into this unit employs a digital signal processing system that automatically stabilizes the volume on each channel to enhance moving sound effects and directionality.

### Dolby TrueHD

Dolby TrueHD is an advanced lossless audio technology developed for high-definition disc-based media including Blu-ray Disc. Selected as an optional audio standard for BD (Blu-ray disc), this technology delivers sound that is bit-for-bit identical to the studio master, offering a high-definition home theater experience. Supporting bitrates up to 18.0 Mbps, Dolby TrueHD can carry up to 8 discrete channels of 24-bit/96 kHz audio simultaneously. Dolby TrueHD also remains fully compatible with the existing multichannel audio systems and retains the metadata capability of Dolby Digital, allowing dialog normalization and dynamic range control.

### DTS 96/24

DTS 96/24 offers an unprecedented level of audio quality for multichannel sound on DVD video, and is fully backward-compatible with all DTS decoders. "96" refers to a 96 kHz sampling rate compared to the typical 48 kHz sampling rate. "24" refers to 24-bit word length. DTS 96/24 offers sound quality transparent to the original 96/24 master, and 96/24 5.1-channel sound with full-quality full-motion video for music programs and motion picture soundtracks on DVD video.

## DTS Digital Surround

DTS Digital Surround was developed to replace the analog soundtracks of movies with a 5.1-channel digital sound track, and is now rapidly gaining popularity in movie theaters around the world. DTS, Inc. has developed a home theater system so that you can enjoy the depth of sound and natural spatial representation of DTS Digital Surround in your home. This system produces practically distortion-free 5.1-channel sound (technically, left, right and center channels, 2 surround channels, plus an LFE 0.1 channel as a subwoofer, for a total of 5.1-channels). This unit incorporates a DTS-ES decoder that enables 6.1-channel reproduction by adding the surround back channel to the existing 5.1-channel format.

## DTS Express

This is an audio format for next-generation optical discs such as BD (Blu-ray disc). It uses optimized low bit rate signals for network streaming. In the case of a BD, this format is used with secondary audio, enabling you to enjoy the commentary of the movie producer via the Internet while playing the main program.

## DTS-HD High Resolution Audio

DTS-HD High Resolution Audio is a high resolution audio technology developed for high-definition disc-based media including BD (Blu-ray disc). Selected as an optional audio standard for BD, this technology delivers sound that is virtually indistinguishable from the original, offering a high-definition home theater experience. Supporting bitrates up to 6.0 Mbps for BD, DTS-HD High Resolution Audio can carry up to 7.1 discrete channels of 24-bit/96 kHz audio simultaneously. DTS-HD High Resolution Audio also remains fully compatible with the existing multichannel audio systems that incorporate DTS Digital Surround.

## DTS-HD Master Audio

DTS-HD Master Audio is an advanced lossless audio technology developed for high-definition disc-based media including BD (Blu-ray disc). Selected as an optional audio standard for BD, this technology delivers sound that is bit-for-bit identical to the studio master, offering a high-definition home theater experience. Supporting bitrates up to 24.5 Mbps for BD, DTS-HD Master Audio can carry up to 7.1 discrete channels of 24-bit/96 kHz audio simultaneously. Supported by HDMI version 1.3 and designed for the optical disc players and AV receivers/amplifiers of the future, DTS-HD Master Audio also remains fully compatible with the existing multichannel audio systems that incorporate DTS Digital Surround.

## DSD

Direct Stream Digital (DSD) technology stores audio signals on digital storage media, such as Super Audio CDs. Using DSD, signals are stored as single bit values at a high-frequency sampling rate of 2.8224 MHz, while noise shaping and oversampling are used to reduce distortion, a common occurrence with very high quantization of audio signals. Due to the high sampling rate, better audio quality can be achieved than that offered by the PCM format used for normal audio CDs. The frequency is equal to or higher than 100 kHz, with a dynamic range of 120 dB. This unit can transmit or receive DSD signals via the HDMI jack.

## FLAC

This is a file format for lossless audio data compression. FLAC is inferior to lossy compression formats in compression rate but provides higher audio quality.

## LFE 0.1 channel

This channel reproduces low-frequency bass signals, and has a frequency range from 20 Hz to 120 Hz. This channel is counted as 0.1, because it only enforces a low-frequency range compared to the full-range reproduced by the other 5-channels in Dolby Digital or DTS 5.1-channel systems.

## MP3

One of the audio compression methods used by MPEG. It employs the irreversible compression method, which achieves a high compression rate by thinning out the data of hardly audible part to the human ears. It is said to be capable of compressing the data quantity by about 1/11 (128 kbps) while maintaining a similar audio quality to music CD.

## MPEG-4 AAC

An MPEG-4 audio standard. As it allows compression of data at a bit rate lower than that of MPEG-2 AAC, it is used among others for mobile telephones, portable audio players and other low-capacity devices requiring high sound quality. In addition to the above types of devices, MPEG-4 AAC is also used to distribute contents on the Internet, and as such is supported by computers, media servers and many other devices.

## Neo:6

Neo:6 decodes the conventional 2-channel sources for 6-channel playback by the specific decoder. It enables playback with the full-range channels with higher separation just like digital discrete signal playback. There are two modes available: "Music mode" for music sources and "Cinema mode" for movie sources.

## PCM (Linear PCM)

Linear PCM is a signal format under which an analog audio signal is digitized, recorded and transmitted without using any compression. This is used as a method of recording CDs and DVD audio. The PCM system uses a technique for sampling the size of the analog signal per very small unit of time. Standing for "Pulse Code Modulation," the analog signal is encoded as pulses and then modulated for recording.

## Sampling frequency and number of quantized bits

When digitizing an analog audio signal, the number of times the signal is sampled per second is called the sampling frequency, while the degree of accuracy when converting the sound level into a numeric value is called the number of quantized bits. The range of rates that can be played back is determined based on the sampling rate, whereas the dynamic range representing the sound level difference is determined by the number of quantized bits. In principle, the higher the sampling frequency, the wider the range of frequencies that can be played back, and the higher the number of quantized bits, the more accurately the sound level can be reproduced.

## SILENT CINEMA

Yamaha has developed a natural, realistic sound effect DSP algorithm for headphones. Parameters for headphones have been set for each sound program, so that accurate representations of all the sound programs can be enjoyed on headphones.

## Virtual CINEMA DSP

Yamaha has developed a Virtual CINEMA DSP algorithm that allows you to enjoy DSP surround effects even without any surround speakers, by using virtual surround speakers. It is even possible to enjoy Virtual CINEMA DSP using a minimal two-speaker system that does not include a center speaker.

## WAV

Windows standard audio file format, which defines the method of recording the digital data obtained by converting audio signals. It does not specify the compression (coding) method so a desired compression method can be used with it. By default, it is compatible with the PCM method (no compression) and some compression methods including the ADPCM method.

## WMA

An audio compression method developed by Microsoft Corporation. It employs the irreversible compression method, which achieves a high compression rate by thinning out the data of hardly audible part to the human ears. It is said to be capable of compressing the data quantity by about 1/22 (64 kbps) while maintaining a similar audio quality to music CD.

# Video information

---

## Component video signal

With the component video signal system, the video signal is separated into the Y signal for luminance and the Pb and Pr signals for chrominance. Color can be reproduced more faithfully with this system because each of these signals is independent. The component signal is also called the "color difference signal" because the luminance signal is subtracted from the color signal. A monitor with component input jacks is required in order to output component signals.

## Composite video signal

With the composite video signal system, the video signal comprises the three basic elements of a video picture: color, brightness and synchronization data. A composite video jack on a video component transmits these three elements combined.

## Deep Color

Deep Color refers to the use of various color depths in displays, up from the 24-bit depths in previous versions of the HDMI specification. This extra bit depth allows HDTVs and other displays increase from millions of colors to billions of colors and eliminate on-screen color banding for smooth tonal transitions and subtle gradations between colors. The increased contrast ratio can represent many times more shades of gray between black and white. Additionally, Deep Color increases the number of available colors within the boundaries defined by the RGB or YCbCr color space.

## HDMI

HDMI (High-Definition Multimedia Interface) is the first industry supported, uncompressed, all-digital audio/video interface. Providing an interface between any sources (such as set-top boxes or AV receivers) and audio/video monitors (such as digital televisions), HDMI supports standard, enhanced or high-definition video as well as multichannel digital audio using a single cable. HDMI transmits all ATSC HDTV standards and supports 8-channel digital audio, with bandwidth to spare to accommodate future enhancements and requirements.

When used in combination with HDCP (High-bandwidth Digital Content Protection), HDMI provides a secure audio/video interface that meets the security requirements of content providers and system operators. For further information on HDMI, visit the HDMI website at "<http://www.hdmi.org/>."

## "x.v.Color"

A color space standard supported by HDMI version 1.3. It is a more extensive color space than sRGB, and allows the expression of colors that were not hitherto possible. While remaining compatible with the color gamut of sRGB standards, "x.v.Color" expands the color space, and can thus produce more vivid, natural images. It is particularly effective for still pictures and computer graphics.

## Video signal flow

Video signals input from a video device to this unit are output to a TV as shown below.

→ (solid line) is always available. → (dotted line) is available only when "Analog to Analog Conversion" (p.93) in the "Setup" menu is set to "On" (default).

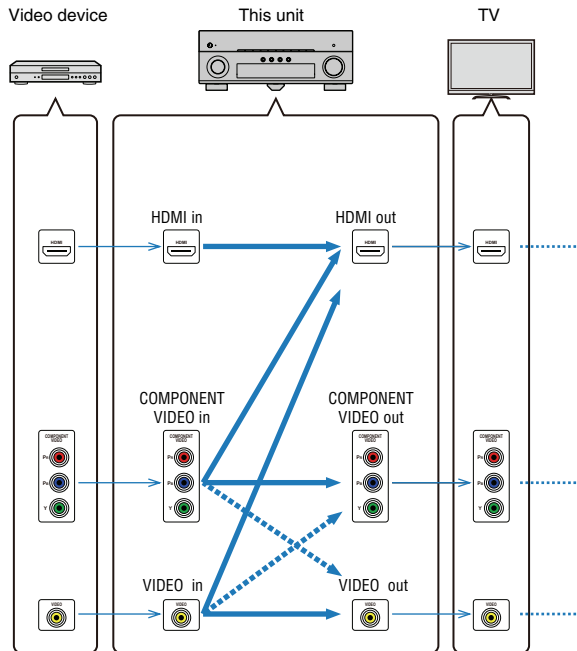

## Video conversion table



- You can select a resolution and an aspect ratio applied to HDMI-output video processing.
- This unit does not convert 480-line and 576-line video signals interchangeably.

	Resolution	HDMI out					COMPONENT VIDEO out					VIDEO out
		480i/576i	480p/576p	720p	1080i	1080p	480i/576i	480p/576p	720p	1080i	1080p	480i/576i
HDMI in	480i/576i	→	→	→	→	→						
	480p/576p		→	→	→	→						
	720p			→								
	1080i				→							
	1080p					→						
COMPONENT VIDEO in	480i/576i	→	→	→	→	→						→
	480p/576p		→	→	→	→		→				
	720p			→					→			
	1080i				→				→			
VIDEO in	480i/576i	→	→	→	→	→	→					→



## Information on HDMI

### HDMI Control

HDMI Control allows you to operate external devices via HDMI. If you connect a TV that supports HDMI Control to this unit with an HDMI cable, you can control this unit (power, volume, etc.) in conjunction with TV remote control operations. You can also control playback devices (HDMI Control-compatible BD/DVD players, etc.) connected to this unit with an HDMI cable.

For details on connections, see “Connecting a TV” (p.21) and “Connecting video devices (BD/DVD players, etc.)” (p.26).

#### Operations available from the TV's remote control

- Standby synchronization
- Volume control including mute
- Switching to input audio from the TV when the TV input is switched to its built-in tuner
- Switching to input video/audio from the selected playback device
- Switching between audio output devices (this unit or TV speaker)

(Example)

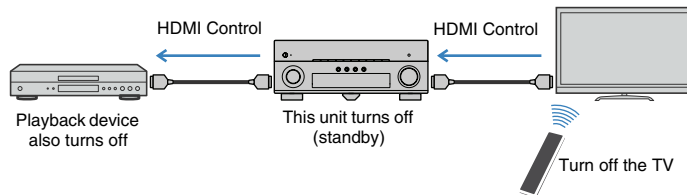

#### Operations available from this unit's remote control

- Starting playback on the playback device and turning on the TV in conjunction with a scene selection (p.43)
- Switching the TV input to display the on-screen menu (when ON SCREEN is pressed)
- Controlling the playback device (playback and menu operations) without registering remote control codes (p.104)

(Example)

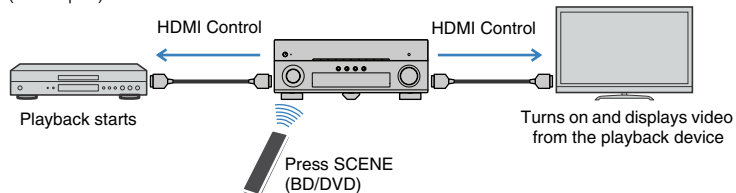

To use HDMI Control, you need to perform the following HDMI Control link setup after connecting the TV and playback devices.



- This setup is required every time when you add a new HDMI Control-compatible device to your system.
- To use HDMI Control, connect the TV to the HDMI OUT 1 jack.

- 1 Turn on this unit, TV and playback devices.**
- 2 Enable HDMI Control on this unit, TV and playback devices (HDMI Control-compatible BD/DVD players, etc).**

To enable HDMI Control on this unit, set “HDMI Control” (p.94) in the “Setup” menu to “On” and configure the related items (“TV Audio Input”, “ARC” and “Standby Sync”).
- 3 Turn off the main power of the TV and then turn off this unit and playback devices.**
- 4 Turn on the main power of the TV and then turn on this unit and playback devices.**
- 5 Switch the TV input to display the video from this unit.**

#### 6 Check the followings.

On this unit: The input to which the playback device is connected is selected. If not, select the input source manually.

On the TV: The video from the playback device is displayed.

#### 7 Check that this unit is properly synchronized with the TV by turning off the TV or adjusting the TV volume with the TV remote control.



- If HDMI Control does not work properly, try unplugging the TV in step 2 and re-plugging the TV in step 3. It may solve the problem. Also, HDMI Control may not work if the number of connected devices is over the limit. In this case, disable HDMI Control on the devices not in use.
- If the unit is not synchronized to the TV's power operations, check the priority of the audio output setting on the TV.
- We recommend using TV and playback devices from the same manufacturer so that HDMI Control works more effectively.

## HDMI signal compatibility

---

### Audio signals

Audio signal type	Audio signal format	Compatible media (example)
2ch Linear PCM	2ch, 32 to 192 kHz, 16/20/24 bit	CD, DVD-Video, DVD-Audio
Multi-channel Linear PCM	8ch, 32 to 192 kHz, 16/20/24 bit	DVD-Audio, BD (Blu-ray disc), HD DVD
DSD	2/5.1ch, 2.8224 MHz, 1 bit	SACD
Bitstream	Dolby Digital, DTS	DVD-Video
Bitstream (High definition audio)	Dolby TrueHD, Dolby Digital Plus, DTS-HD Master Audio, DTS-HD High Resolution Audio, DTS Express	BD (Blu-ray disc), HD DVD

### Video signals

This unit is compatible with the video signals of the following resolutions:

- 480i/60 Hz
- 576i/50 Hz
- 480p/60 Hz
- 576p/50 Hz
- 720p/60 Hz, 50 Hz
- 1080i/60 Hz, 50 Hz
- 1080p/60 Hz, 50 Hz, 24 Hz



- When CPPM copy-protected DVD-Audio is played back, video/audio signals may not be output, depending on the type of the DVD player.
- This unit is not compatible with HDCP-incompatible HDMI or DVI devices. For details, refer to the instruction manual of each device.
- To decode audio bitstream signals on this unit, set the input source device appropriately so that the device outputs the bitstream audio signals directly (does not decode the bitstream signals on the playback device). For details, refer to the instruction manual of the playback device.
- This unit is not compatible with the audio commentary features (for example, the special audio contents downloaded via Internet) of BD or HD DVD. This unit does not playback the audio commentaries of the BD or HD DVD content.

## Reference diagram (rear panel)

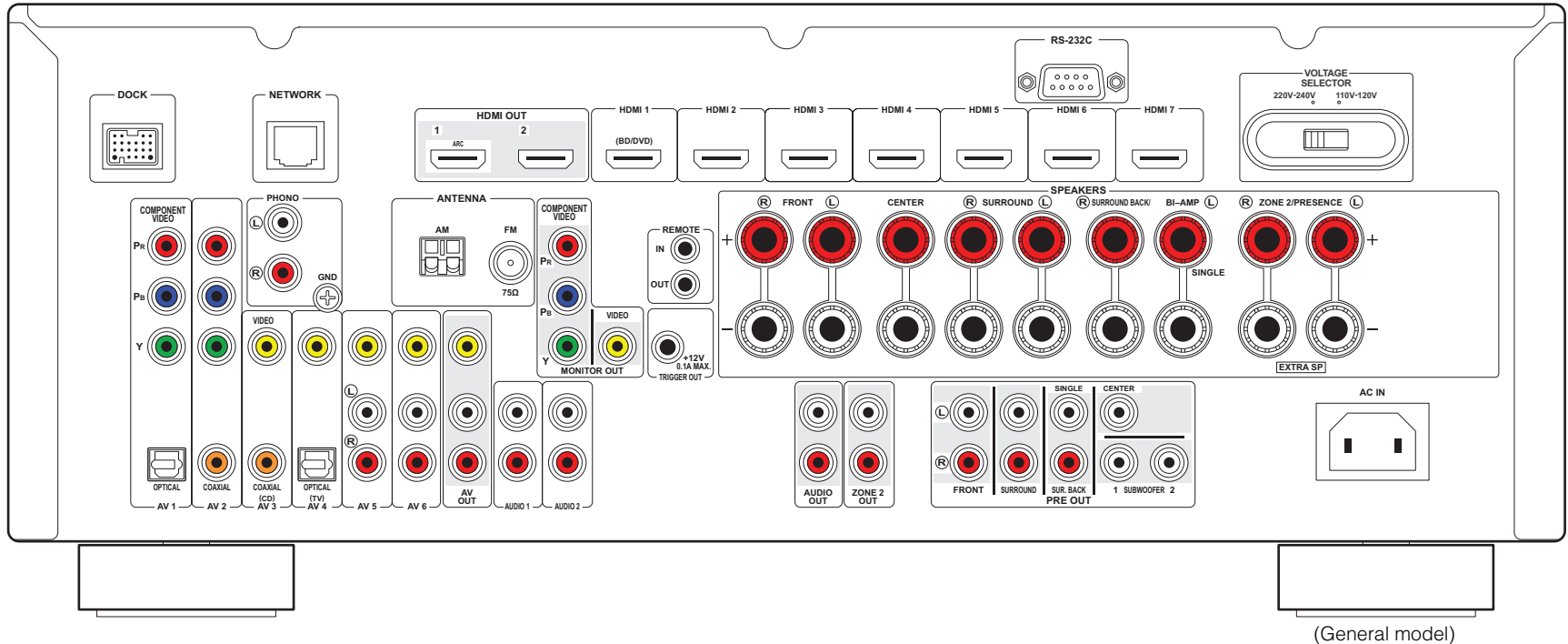

- The area around the video/audio output jacks is marked in white on the actual product.

## Trademarks



Manufactured under license from Dolby Laboratories. Dolby, Pro Logic and the double-D symbol are trademarks of Dolby Laboratories.



Manufactured under license under U.S. Patent #'s: 5,451,942; 5,956,674; 5,974,380; 5,978,762; 6,226,616; 6,487,535; 7,212,872; 7,333,929; 7,392,195; 7,272,567 & other U.S. and worldwide patents issued & pending. DTS and the Symbol are registered trademarks, & DTS-HD, DTS-HD Master Audio, and the DTS logos are trademarks of DTS, Inc. Product includes software. © DTS, Inc. All Rights Reserved.

### iPod™, iPhone™

"Made for iPod" and "Made for iPhone" mean that an electronic accessory has been designed to connect specifically to iPod or iPhone, respectively, and has been certified by the developer to meet Apple performance standards. Apple is not responsible for the operation of this device or its compliance with safety and regulatory standards. Please note that the use of this accessory with iPod or iPhone may affect wireless performance.

iPhone, iPod, iPod classic, iPod nano, and iPod touch are trademarks of Apple Inc., registered in the U.S. and other countries.



**Fraunhofer** Institut  
Integrierte Schaltungen

MPEG Layer-3 audio coding technology licensed from Fraunhofer IIS and Thomson.



This receiver supports network connections.

### Bluetooth™

Bluetooth is a registered trademark of the Bluetooth SIG and is used by Yamaha in accordance with a license agreement.



"HDMI," the "HDMI" logo and "High-Definition Multimedia Interface" are trademarks, or registered trademarks of HDMI Licensing LLC.

### x.v.Color™

"x.v.Color" is a trademark of Sony Corporation.



"SILENT CINEMA" is a trademark of Yamaha Corporation.



DLNA Certified is a trademark of the Digital Living Network Alliance in the United States and other countries.



Windows is a registered trademark of Microsoft Corporation in the United States and other countries.

Windows XP, Windows Vista, Windows 7, Windows Media Audio, Windows Media Connect and Windows Media Player are either registered trademarks or trademarks of Microsoft corporation in the United States and/or other countries.

# Specifications

## Input jacks

- Analog Audio  
[U.S.A. and Canada models]  
Audio x 5 (AV5~6, AUDIO1~2, V-AUX)  
[Other models]  
Audio x 6 (AV5~6, AUDIO1~2, PHONO, V-AUX)
- Digital Audio (Support fs: 32 kHz to 96 kHz)  
Optical x 2 (AV1, AV4)  
Coaxial x 2 (AV2, AV3)
- Video  
Composite x 5 (AV3~6, V-AUX)  
S-Video x 1 (AV5) [U.K. and Europe models]  
Component x 2 (AV1~2)
- HDMI Input  
HDMI (Front Panel) x 1 (V-AUX)  
HDMI (Rear Panel) x 7 (HDMI1~7)
- Other  
DOCK x 1 (Audio, Composite Video)  
USB x 1 (USB2.0)  
NETWORK x 1 (100Base-TX)

## Output jacks

- Analog Audio  
Speaker out x 9 (7 ch) (FRONT L/R, CENTER, SURROUND L/R, SURROUND BACK L/R\*1, EXTRA SP L/R\*2)  
\*1 Note: assignment is possible. [SURROUND BACK, BI-AMP (FRONT L/R)]  
\*2 Note: assignment is possible. [ZONE2, PRESENCE]  
Pre Out x 7 (FRONT L/R, CENTER, SURROUND L/R, SURROUND BACK L/R)  
Subwoofer Out x 2 (SUBWOOFER 1~2, mono)  
AV OUT x 1  
AUDIO OUT x 1  
ZONE2 OUT x 1

- Video  
MONITOR OUT  
- Component x 1  
- Composite x 1  
AV OUT  
- Composite x 1
- HDMI Output  
HDMI OUT x 2 (HDMI OUT1~2)

## Remote jacks

- REMOTE IN x 1
- REMOTE OUT x 1
- TRIGGER OUT x 1

## HDMI

- HDMI Specification: Deep Color, "x.v.Color," Auto Lip Sync, HDMI Control (CEC), ARC (Audio Return Channel), 3D
- Video Format (Repeater Mode)
  - VGA
  - 480i/60 Hz
  - 576i/50 Hz
  - 480p/60 Hz
  - 576p/50 Hz
  - 720p/60 Hz, 50 Hz
  - 1080i/60 Hz, 50 Hz
  - 1080p/60 Hz, 50 Hz, 24 Hz
- Audio Format
  - Dolby Digital
  - DTS
  - DSD 6ch
  - Dolby Digital Plus
  - Dolby TrueHD
  - DTS-HD
  - PCM 2ch-8ch (Max 192 kHz/24 bit)
- Content Protection: HDCP compatible

## TUNER

- Analog Tuner  
[U.K. and Europe models]  
FM/AM with RDS x 1 (TUNER)  
[Other models]  
FM/AM x 1 (TUNER)
- Satellite Radio Ready [U.S.A. model]  
SIRIUS Radio x 1 (SIRIUS)

## USB

- Capable of iPod, Mass Storage Class USB Memory, MTP (Media Transfer Protocol)
- Current Supply Capacity: 1 A

## Network

- PC Client Function
- Compatible with Windows 7, DLNA ver. 1.5
- Internet Radio

## Compatible Decoding Formats

- Decoding Format
  - Dolby TrueHD, Dolby Digital Plus
  - DTS-HD Master Audio, DTS-HD High Resolution, DTS Express
  - Dolby Digital, Dolby Digital EX
  - DTS, DTS 96/24, DTS-ES Matrix 6.1, DTS-ES Discrete 6.1
- Post Decoding Format
  - Dolby Pro Logic
  - Dolby Pro Logic II Music, Dolby Pro Logic II Movie, Dolby Pro Logic II Game
  - Dolby Pro Logic IIx Music, Dolby Pro Logic IIx Movie, Dolby Pro Logic IIx Game
  - DTS Neo:6 Music, DTS Neo:6 Cinema

## Audio Section

- **Rated Output Power**  
(20 Hz to 20 kHz, 0.09% THD, 8Ω)  
Front L/R ..... 100 W+100 W  
(1 kHz, 0.9% THD, 8Ω)  
Front L/R ..... 130 W/ch (110 W+110 W)  
Center ..... 130 W/ch (110 W)  
Surround L/R ..... 130 W/ch (110 W+110 W)  
Surround Back L/R ..... 130 W/ch (110 W+110 W)
- **Maximum Effective Output Power (JEITA, 1 kHz, 10% THD, 8 Ω)**  
[China, Asia and General models]  
Front L/R ..... 160 W/ch  
Center ..... 160 W/ch  
Surround L/R ..... 160 W/ch  
Surround Back L/R ..... 160 W/ch
- **Dynamic Power (IHF)**  
Front L/R (8/6/4/2 Ω) ..... 140/180/210/250 W
- **Damping Factor**  
Front L/R, 20 Hz to 20 kHz, 8 Ω ..... 100 or more
- **Input Sensitivity / Input Impedance**  
[U.S.A. and Canada models]  
AV5 etc. (1 kHz, 100 W/8 Ω) ..... 200 mV/47 kΩ  
[Other models]  
PHONO (1 kHz, 100 W/8 Ω) ..... 3.5 mV/47 kΩ  
AV5 etc. (1 kHz, 100 W/8 Ω) ..... 200 mV/47 kΩ
- **Maximum Input Signal**  
[U.S.A. and Canada models]  
AV5 etc. (1 kHz, 0.5% THD, Effect On) ..... 2.3 V  
[Other models]  
PHONO (1 kHz, 0.1% THD) ..... 60 mV  
AV5 etc. (1 kHz, 0.5% THD, Effect On) ..... 2.3 V
- **Output Level / Output Impedance**  
REC OUT ..... 200 mV/1.2 kΩ  
SUBWOOFER (2ch Stereo, Front: Small) ..... 1 V/1.2 kΩ  
ZONE2 OUT ..... 200 mV/1.2 kΩ
- **Headphone Jack Rated Output / Impedance**  
AV5 etc. (1 kHz, 50 mV, 8 Ω) ..... 100 mV/560 Ω

- **Frequency Response**  
AV5 etc. to Front (10 kHz to 100 kHz) ..... +0/-3 dB
- **RIAA Equalization Deviation**  
[China, Korea, Australia, U.K. and Europe, Asia and General models]  
PHONO ..... 0±0.5 dB
- **Total Harmonic Distortion**  
[U.S.A. and Canada models]  
AV5 etc. to Front (Pure Direct)  
(20 to 20 kHz, 50 W/8 Ω) ..... 0.06% or less  
[Other models]  
PHONO to REC OUT (20 to 20 kHz, 1 V) ..... 0.02% or less  
AV5 etc. to Front (Pure Direct)  
(20 to 20 kHz, 50 W/8 Ω) ..... 0.06% or less
- **Signal to Noise Ratio (IHF-A Network)**  
[U.S.A. and Canada models]  
AV5 etc.  
(Pure Direct, Input Shorted 250 mV, SP OUT) ..... 100 dB or more  
[Other models]  
PHONO (Input Shorted 5 mV, REC OUT) ..... 81 dB or more  
AV5 etc.  
(Pure Direct, Input Shorted 250 mV, SP OUT) ..... 100 dB or more
- **Residual Noise (IHF-A Network)**  
Front L/R (SP OUT) ..... 150 μV or less
- **Channel Separation**  
[U.S.A. and Canada models]  
AV5 etc.  
(Input 5.1 kΩ Shorted, 1 kHz/10 kHz) ..... 60 dB/45 dB or more  
[Other models]  
PHONO (Input Shorted, 1 kHz/10 kHz) ... 60 dB/55 dB or more  
AV5 etc.  
(Input 5.1 kΩ Shorted, 1 kHz/10 kHz) ..... 60 dB/45 dB or more
- **Volume Control**  
Range ..... MUTE, -80 dB to +16.5 dB  
Step ..... 0.5 dB
- **Tone Control Characteristics (Front L/R)**  
Bass Boost/Cut ..... ±6 dB/0.5 dB Step at 50 Hz  
Bass Turnover ..... 350 Hz

Treble Boost/Cut ..... ±6 dB/0.5 dB Step at 20 kHz  
Treble Turnover ..... 3.5 kHz

- **Filter Characteristics**  
( $f_c=40/60/80/90/100/110/120/160/200$  Hz)  
H.P.F. (Front, Center, Surround, Surround Back) ..... 12 dB/oct.  
L.P.F. (Subwoofer) ..... 24 dB/oct.

## Video Section

- **Video Signal Type**  
[U.S.A., Canada, Korea and General models] ..... NTSC  
[Other models] ..... PAL
- **Video Signal Type (Video Conversion)** ..... NTSC/PAL
- **Video Signal Level**  
Composite ..... 1 Vp-p/75 Ω  
S-Video [U.K. and Europe models]  
Y ..... 1 Vp-p/75 Ω  
C ..... 0.286 Vp-p/75 Ω  
Component  
Y ..... 1 Vp-p/75 Ω
- **Video Maximum Input Level (Video Conversion Off)**  
..... 1.5 Vp-p or more
- **Video Signal to Noise Ratio** ..... 50 dB or more
- **Monitor Out Frequency Response (Video Conversion Off)**  
Component ..... 5 Hz to 60 MHz, -3 dB

## FM Section

- Tuning Range  
[U.S.A. and Canada models] ..... 87.5 MHz to 107.9 MHz  
[Asia and General models]  
..... 87.5/87.50 MHz to 108.0/108.00 MHz  
[Other models]..... 87.50 MHz to 108.00 MHz
- 50 dB Quiet Sensitivity (IHF, 1 kHz, 100% MOD.)  
Mono..... 3  $\mu$ V (20.8 dBf)
- Signal to Noise Ratio (IHF)  
Mono..... 71 dB  
Stereo ..... 69 dB
- Harmonic Distortion (IHF, 1 kHz)  
Mono..... 0.3%  
Stereo ..... 0.5%
- Antenna Input ..... 75  $\Omega$  unbalanced

## AM section

- Tuning Range  
[U.S.A. and Canada models] ..... 530 kHz to 1710 kHz  
[Asia and General models]..... 530/531 kHz to 1710/1611 kHz  
[Other models]..... 531 kHz to 1611 kHz

## General

- Power Supply  
[U.S.A. and Canada models] ..... AC 120 V, 60 Hz  
[General model]..... AC 110-120/220-240 V, 50/60 Hz  
[China model] ..... AC 220 V, 50 Hz  
[Korea model] ..... AC 220 V, 60 Hz  
[Australia model] ..... AC 240 V, 50 Hz  
[U.K. and Europe models] ..... AC 230 V, 50 Hz  
[Asia model] ..... AC 220-240 V, 50/60 Hz
- Power Consumption  
[U.S.A. and Canada models] ..... 400 W/500 VA  
[Asia and General models]..... 300 W  
[Other models]..... 330 W
- Standby Power Consumption  
HDMI Control Off / Standby Through Off ..... 0.1 W or less  
HDMI Control On/Standby Through On (Typical) ..... 2.0 W

- Network Standby On (Typical) ..... 2.0 W
- Maximum Power Consumption  
[Asia and General models] ..... 590 W
- Dimensions (W x H x D) ..... 435 x 171 x 369 mm  
(17-1/8" x 6-3/4" x 14-1/2")
- Weight ..... 11.1 kg (24.5 lbs)

\* Specifications are subject to change without notice.



YAMAHA CORPORATION

© 2011 Yamaha Corporation  YD455C0/OMEN4