

**EM-100II
EM-150IIB**

**EM-200B
EM-300B**

OPERATING MANUAL

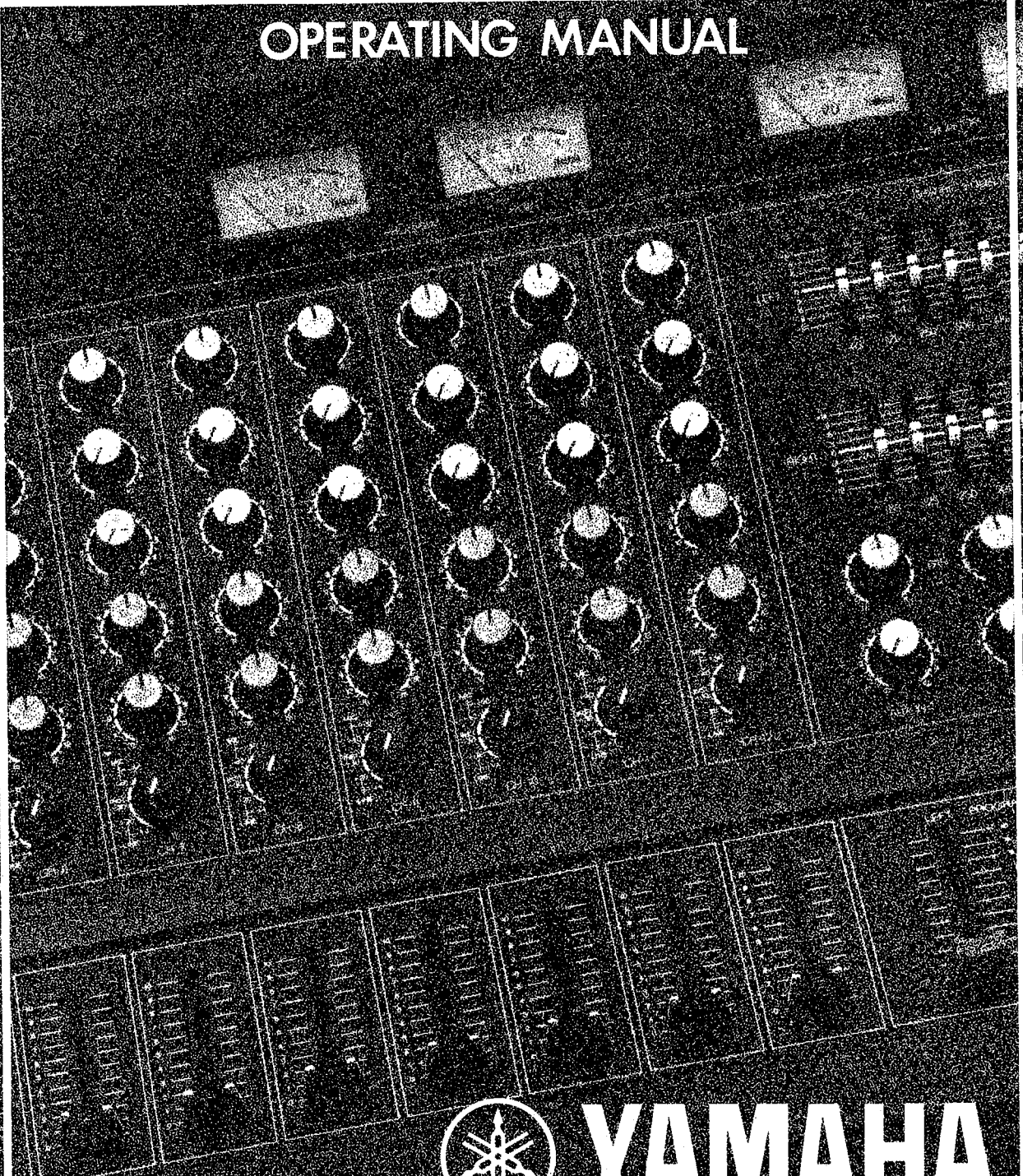

YAMAHA

How to use this manual

Yamaha EM-Mixers are equipped with features and capabilities unique among mixers in their price range. To take the best advantage of your mixer, we recommend careful reading of this Instruction Manual . . . even if you already have a good general understanding of mixers. The setups on the following pages are meant only as guidelines. We have attempted to cover many applications. It would be impossible to cover all conceivable setups, which are infinite as your own imagination.

Index

SECTION ONE	2
Brief Operating Instructions	
Functional descriptions of each control, each meter, and the input/output/accessory jacks. Also, mixer specifications.	
SECTION TWO	8
Introduction	
A general description of the EM-Mixers, their features and capabilities, and how to use them.	
SECTION THREE	10
Detailed Instructions	
Detailed descriptions of operating procedures, control functions, jack functions, and connections to speakers and accessory equipment.	
SECTION FOUR	14
Applications	
Detailed discussion of several applications from sound reinforcement (PA) to recording.	
SECTION FIVE	19
Balanced Input Transformer Modules	
Installation instructions for balanced input transformer modules or Yamaha EM-150IIB, EM-200B and EM-300B.	
Block Diagrams	
Troubleshooting	
Warranty and Service	
The EM-Mixer Warranty, and what to do if you should encounter any problems. Also, a procedure to verify proper performance.	

SECTION ONE

Brief Operating Instructions

NOTE: Be sure the AC POWER switch is turned OFF when making all signal and speaker connections.

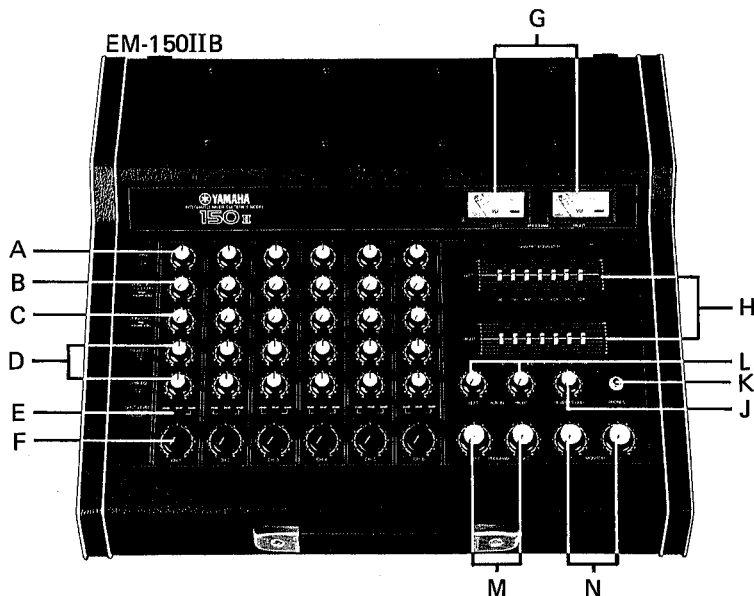
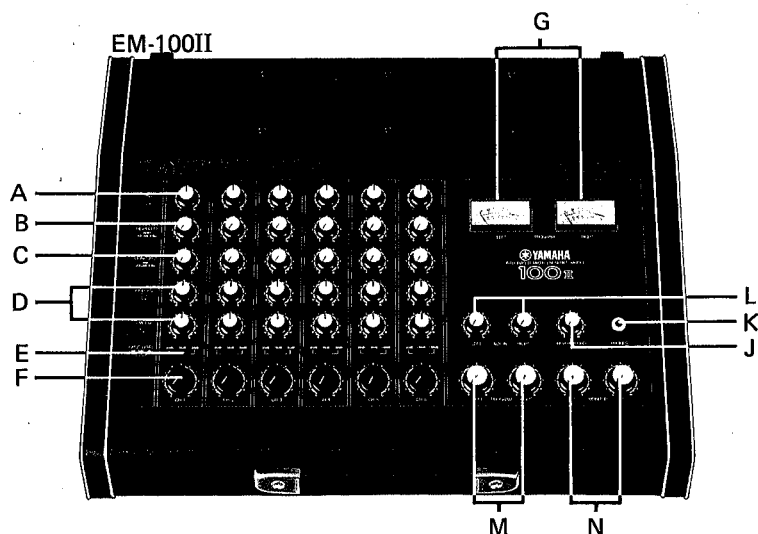

FRONT PANEL

- A. Pan** This knob feeds the input channel signal to a pair of mix buses to create the stereo program mix (Left and Right program buses). The stereo program bus then feeds the Speaker, Line, and Headphone outputs via the Master Program faders.
- B. Monitor 1 Send (Rev/Echo)** This knob feeds the input signal to the mix bus which, in turn, feeds the Monitor 1 output. The same bus also drives the built-in reverb or external reverb/echo (effects) units; the send is post-EQ and fader.
- C. Monitor 2 Send** This knob feeds a pre-EQ and pre-fader signal to a second monitor mix bus which, in turn, feeds the Monitor 2 output.
- D. High and Low EQ Controls** These continuously adjustable knobs allow for ± 15 dB of bass and treble equalization on each input channel. Response is "flat" at center position.
- E. Input Level Selector Switch** This switch adjusts the input channel's sensitivity for best results with different input sources. For Models EM-100II and EM-150IIB this switch is a 3-position slide switch (Line/Instr/Mic). On the EM-200B and EM-300B, the level switch is a 5-position rotary knob.
- F. Channel Fader** On Models EM-100II and EM-150IIB rotary faders set the mix level of each channel. Models EM-200B and EM-300B have smooth linear slide faders that also provide a good visual indication of the mix-level for each channel.
- G. VU Meters** Two meters indicate the average speaker power output level. On the EM-300B, an additional set of meters indicates the average output level of the two Monitor mix buses. The meters are illuminated when AC POWER is ON.

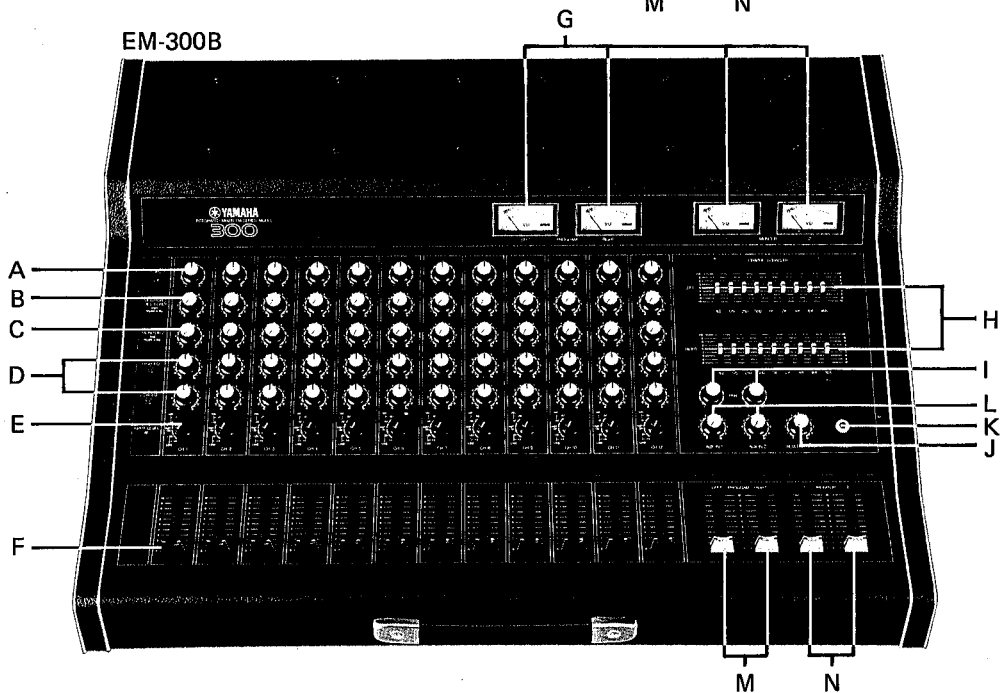
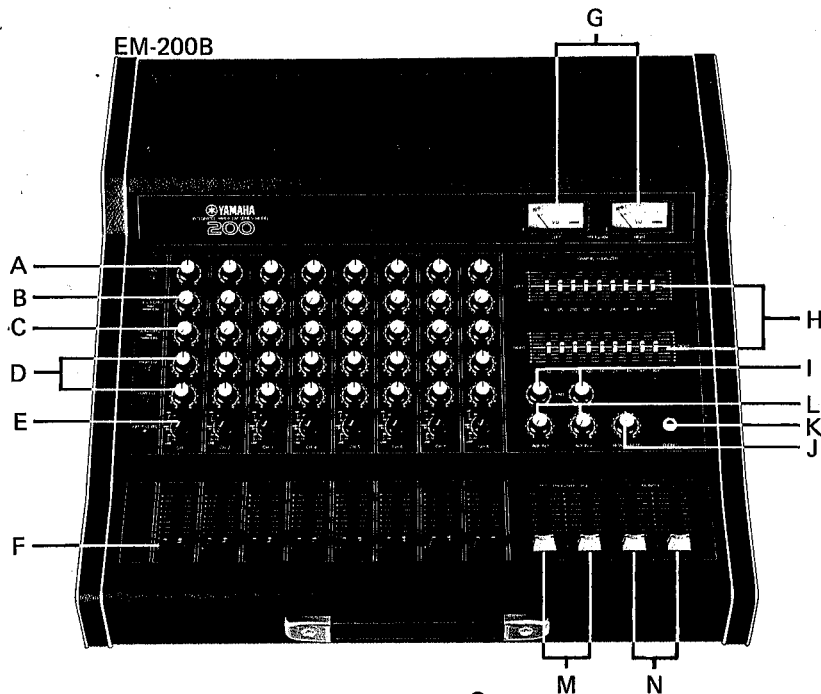

- H. Graphic Equalizer** (Except on EM-100II) Two banks of linear slide controls independently vary the frequency response of the Left and Right Program outputs. There are seven G-EQ controls per channel on the EM-150IIB and nine controls per channel on the EM-200B and EM-300B. Center detents mark the "flat" position (no EQ effect) for each control.
- I. Aux Pan** (Models EM-200B and EM-300B only) These controls position the Aux 1 and Aux 2 Input signals Left-to-Right on the stereo program bus.
- J. Master Reverb/Echo** This control sets the level at which the returning Reverb/Echo signal (or the reverb from the built-in spring) is mixed into the stereo program bus. (The mono signal is applied equally to the Left and Right program mix buses and is thus a "center" effects return.) If the Echo Return jack is used as an auxiliary monaural line input, Master Reverb/Echo adjusts the level of the "auxiliary" input source.

- K. Headphones Jack** This TRS (tip-ring-sleeve) stereo phone jack can be used with any stereo headphones. It carries the same signal as the Speaker outputs, but at lower level. The headphone volume is controlled by the Master Program faders.
- L. Auxiliary Volume** These controls set the level of any program fed to the mixer via the Left and Right Aux Input jacks. Following these controls, the aux inputs are also affected by the Master Program faders.
- M. Master Program Faders (Left and Right)** These controls adjust the level of corresponding Left and Right program mixing buses which simultaneously feed the Speaker, Graphic EQ, Line, and Headphone outputs.* The Master Program faders DO NOT affect the mixer's Monitor or Echo outputs.
- N. Master Monitor Faders (1 & 2)** These controls adjust the overall level of the Monitor Outputs.

*NOTE: In this manual, we use the terms "stereo program bus" and "Left and Right program mixing buses" interchangeably.

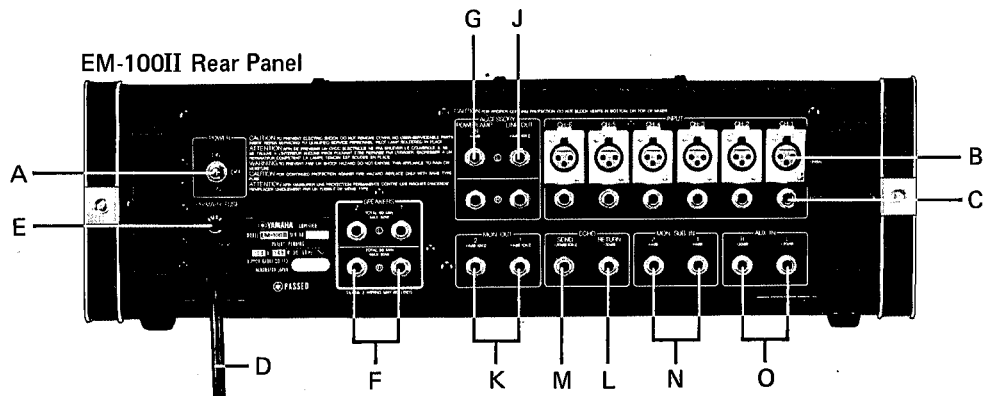

EM-150IIB Rear Panel

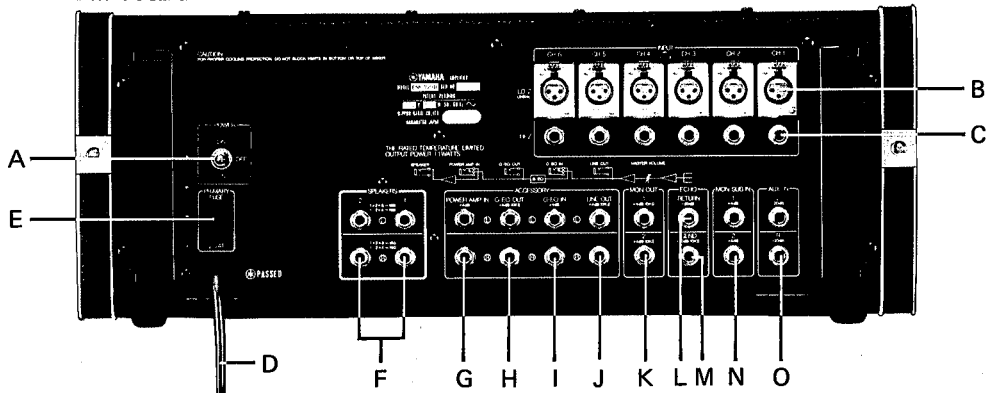

REAR PANEL

- A. Power Switch** This toggle switch has two "ON" positions that reverse the AC power line polarity. Choose the ON position with least hum.
- B. Low Impedance Channel Inputs** These low-impedance XLR connectors accept inputs such as professional low-impedance microphones and electronic musical instruments having low impedance outputs. The XLR inputs are unbalanced,* but may be converted to balanced (floating) inputs by the addition of easy-to-install optional "Balancing Transformer Modules" (not available for the EM-100II).
- C. High Impedance Channel Inputs** These TS (tip-sleeve) phone jacks are designed for high or medium impedance microphones, low-level instruments (like electric guitars or instruments with pick-ups), or high level instruments (such as keyboards).
- D. AC Power Cord** This 3-wire cord is for connection to any 110-120 V AC, 50 or 60 Hz grounded outlet.

- E. Fuse Holders** Always replace the fuses with the same size and type (AGC or equivalent).
- F. Speaker Output Jacks** These standard phone jacks are Left and Right speaker-level outputs from the built-in stereo power amplifier. There are two paralleled jacks per channel; this internal "Y" adapter is provided as a convenience to power two separate sets of speakers simultaneously. (Refer to page 11).
Normally, the Program mixing buses feed the speaker outputs, and both jacks from each power amp channel are simultaneously controlled by the corresponding Master Program faders. The Power Amp In jacks do permit other signal sources to feed the speaker outputs (in lieu of the stereo program mix), such as the monitor mix buses or even an external mixer or keyboard.
- G. Power Amp Inputs** These jacks permit the connection of any line-level low or high impedance signal directly to the mixer's power amplifier, replacing the internal signal flow from the stereo program mix. The jacks are useful for inserting a compressor/limiter ahead of the power amp.

**NOTE: The terms balanced and unbalanced, as used in this manual, have nothing to do with stereo perspective or signal level. Balanced refers to a 2-conductor shielded cable in which neither signal-carrying wire is grounded.*

EM-200B Rear Panel

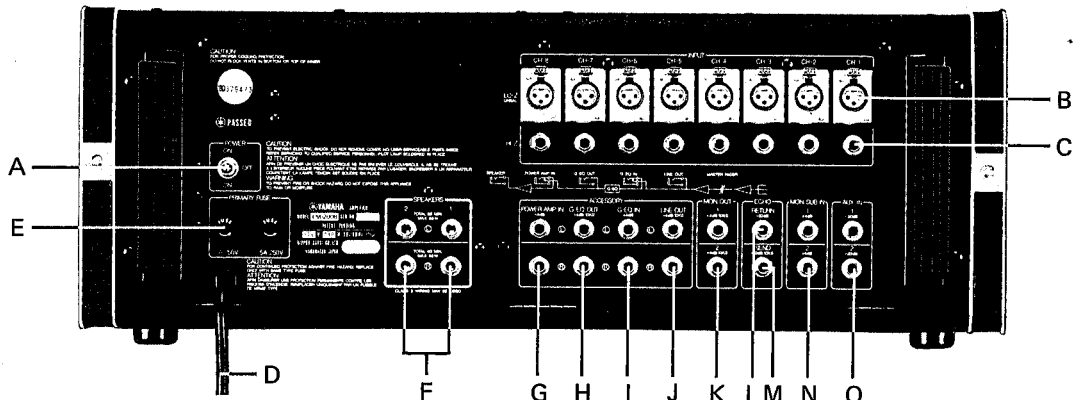

EM-300B Rear Panel

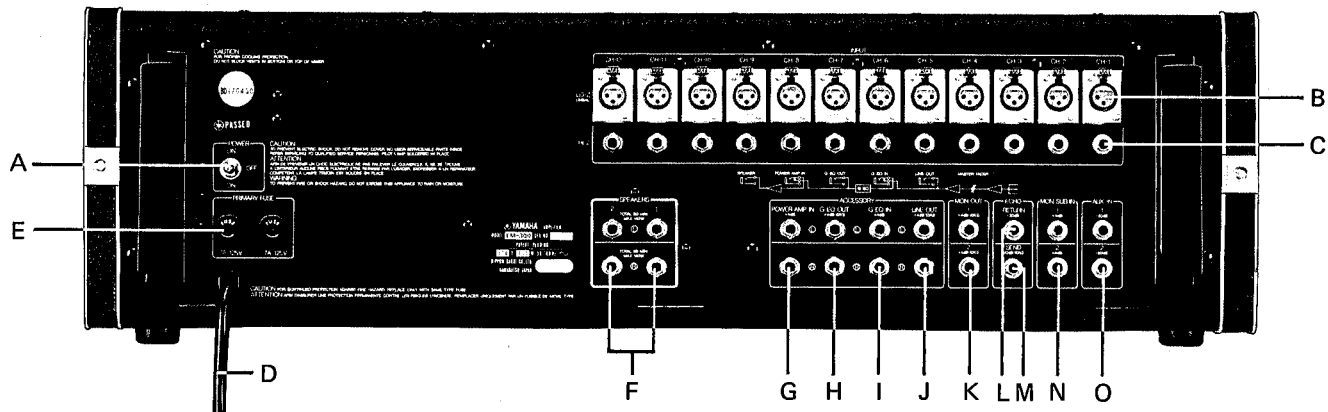

CAUTION: NEVER CONNECT THE MIXER'S SPEAKER OUTPUTS, OR ANY OTHER SPEAKER-LEVEL SIGNAL, TO THE POWER AMP OR G-EQ INPUTS.

H. Graphic EQ Outputs (Not on EM-100II) These jacks feed the signal from the two Graphic Equalizers to any line-level high impedance input, for instance an additional external power amplifier or a compressor/limiter. The signals are also applied, internally, to the mixer's stereo power amplifier, regardless of whether these jacks are in use.

I. Graphic EQ Input Jacks (Not on EM-100II) These standard phone jacks connect a line-level, high-impedance source into the Left and Right Graphic Equalizers, replacing the normal, internal signal flow from the Mixer's line outputs to the Graphic EQ inputs.

J. Line Output Jacks These standard phone jacks are high-impedance, line-level outputs carrying the Left and Right program mix.

K. Monitor Output Jacks These standard phone jacks are high impedance line-level outputs carrying the respective Monitor 1 & 2 mixes. They are controlled by the Master Monitor faders (the Master Program faders have no effect here).

L. Echo Return Jack This standard phone jack accepts the output of an external echo device or any other high-impedance, line-level source. Return level is controlled by the Master Reverb/Echo control. Use of this jack disconnects the internal Reverb spring. Note: If Echo Send is patched directly into Echo return, the Monitor 1 bus may be used for a group submix (positioned at stereo center); the subgroup level is then set by Master Reverb/Echo.

M. Echo Send Jack This standard phone jack feeds the mixed signal from all channels' Monitor 1 controls to an external echo, reverb, or digital delay device. Not affected by the Master Reverb/Echo control, Echo Send can be used as a mono auxiliary low-level line output (-20 dB) when the Monitor 1 output level (+4 dB) is too high.

N. Monitor Sub Input Jacks These high-impedance standard phone jacks apply line-level, low or high impedance inputs directly to the Monitor 1 & 2 mix buses. The Monitor Sub Inputs are subject to the Master Monitor faders.

O. Auxiliary Input Jacks These Left and Right standard phone jacks apply line-level, high impedance inputs to the Left and Right Program Mixing buses. Incoming signal level is controlled by the Aux Volume controls and the Master Program faders.

GENERAL SPECIFICATIONS

MODEL	EM-100II	EM-150IIB	EM-200B	EM-300B
NUMBER OF INPUTS	CHANNEL 1 to 6 (HI-Z & LO-Z), AUX IN (L & R), MONITOR SUB IN (1 & 2), ECHO RETURN, POWER AMP IN (L & R).	CHANNEL 1 to 6 (HI-Z & LO-Z), AUX IN (L & R), MONITOR SUB IN (1 & 2), ECHO RETURN, GRAPHIC EQ IN (L & R), POWER AMP IN (L & R).	CHANNEL 1 to 8 (HI-Z & LO-Z), AUX IN (1 & 2), MONITOR SUB IN (1 & 2), ECHO RETURN, GRAPHIC EQ IN (L & R), POWER AMP IN (L & R).	Like EM-200B, but 12 channel inputs.
INPUT CHANNEL CONTROLS	VOLUME, INPUT LEVEL (-50/-35/-20 dB* sensitivity selector switch), HIGH-EQ, LOW-EQ, MONITOR 1 (REV/ECHO), MONITOR 2, PAN		FADER, INPUT LEVEL (-50/-40/-30/-20/+4 dB* sensitivity selector switch), HIGH-EQ, LOW-EQ, MONITOR 1 (REV/ECHO), MONITOR 2, PAN	
MIXING BUSES	Program (L & R), Monitor (1 & 2).			
NUMBER OF OUTPUTS	SPEAKERS (L & R x 2), MONITOR OUT (1 & 2), ECHO SEND, LINE OUT (L & R), PHONES (stereo).	SPEAKERS (L & R x 2), MONITOR OUT (1 & 2), ECHO SEND, LINE OUT (L & R), GRAPHIC EQ OUT (L & R), PHONES (stereo).		
MASTER CONTROLS	PROGRAM (L & R), MONITOR (1 & 2), REVERB/ECHO, AUX IN (L & R).		PROGRAM faders (L & R), MONITOR faders (1 & 2), REVERB/ECHO, AUX IN (1 & 2), AUX PAN (1 & 2).	
ECHO AND REVERB	Built-in Accutronics spring-type reverberation unit; provisions for connection of external reverb, echo delay or other effects devices.			
MAXIMUM VOLTAGE GAIN	78 dB, CHANNEL IN to SPEAKER OUT; 54 dB, CHANNEL IN to MONITOR OUT; 30 dB, CHANNEL IN to ECHO SEND; 54 dB, CHANNEL IN to LINE OUT; 48 dB, AUX IN to SPEAKER OUT.	80 dB, CHANNEL IN to SPEAKER OUT; 54 dB, CHANNEL IN to MONITOR OUT; 30 dB, CHANNEL IN to ECHO SEND; 54 dB, CHANNEL IN to LINE OUT; 54 dB, CHANNEL IN to G-EQ OUT; 50 dB, AUX IN to SPEAKER OUT.	82 dB, CHANNEL IN to SPEAKER OUT; 54 dB, CHANNEL IN to MONITOR OUT; 30 dB, CHANNEL IN to ECHO SEND; 54 dB, CHANNEL IN to LINE OUT; 54 dB, CHANNEL IN to G-EQ OUT; 52 dB, AUX IN to SPEAKER OUT.	
CHANNEL EQUALIZATION	LOW-EQ, ± 15 dB max. at 100Hz; HIGH-EQ ± 15 dB max. at 10 kHz, shelving characteristic.			
GRAPHIC EQUALIZATION (Speaker Outputs)	N/A	± 12 dB max. at 60 Hz, 150 Hz, 400 Hz, 1 kHz, 2.5 kHz, 5 kHz & 10 kHz, "flat" at center detents.	± 12 dB max. at 63 Hz, 125 Hz, 250 Hz, 500 Hz, 1 kHz, 2 kHz, 4 kHz, 8 kHz & 16 kHz; "flat" at center detents.	
CROSSTALK	-55 dB @ 1 kHz, adjacent inputs or input-to-output.			
AMPLIFIER TYPE	All solid state, discrete and integrated circuit (IC).			
POWER REQUIREMENTS	120 V AC, 50 or 60 Hz, 3-wire outlet, 140 watts.	Like EM-100II, but 170 watts.	Like EM-100II, but 290 watts.	Like EM-100II, but 400 watts.
AC MAINS FUSE(S)	One 3 ampere, AGC type fuse.	One 7 ampere, AGC type fuse.	Two 5 ampere, AGC type, in parallel configuration.	Two 7 ampere, AGC type, in parallel configuration.
OUTPUT PROTECTION	Output power delivered to speakers decreases as load impedance falls below 2.5 ohms; relay mutes input to power amplifier to protect speakers from Turn-ON or Turn-OFF transients.			
INDICATOR(S)	2 illuminated Speaker Out VU meters; 0 VU=25 watts into 8 ohms.	Like EM-100II, but 0 VU=38 W.	Like EM-100II, but 0 VU=43 W.	Like EM-100II, but 0 VU=70 W. 2 illuminated Monitor VU meters, 0 VU=+4 dB* into 10 kohms.
PHYSICAL DIMENSIONS W x H x D:	56 x 17.1 x 47 cm (22 x 6 3/4 x 18 1/2")	56 x 21.4 x 50.8 cm (22 x 8 3/8 x 20")	62.1 x 22.9 x 63.1 cm (24 1/2 x 9 x 24 3/4")	78.7 x 22.9 x 63.1 cm (31 x 9 x 24 3/4")
Weight:	16 kg (35.3 lbs.)	24.5 kg (54 lbs.)	28 kg (61.7 lbs.)	35 kg (77.2 lbs.)
FINISH	Black, with protective aluminum trim.			
WARRANTY	Limited, one (1) year on parts & labor.			
SPEAKER OUTPUT PERFORMANCE				
POWER OUTPUT/CHANNEL (Measured at 0.5% THD point; continuous RMS voltage squared/load; both channels driven.)	50 watts into 8 ohms @ 1 kHz; 45 watts into 8 ohms @ 20 Hz to 20 kHz.	75 watts into 8 ohms @ 1 kHz; 65 watts into 8 ohms @ 20 Hz to 20 kHz.	85 watts into 8 ohms @ 1 kHz; 75 watts into 8 ohms @ 20 Hz to 20 kHz.	140 watts into 8 ohms @ 1 kHz; 120 watts into 8 ohms @ 20 Hz to 20 kHz.
FREQUENCY RESPONSE	± 1 dB, 30 Hz to 15 kHz, +1 dB, -3 dB, 20 Hz to 20 kHz, at 25 watts output into 8 ohms.	Like EM-100II, but measured at 35 watts output.	± 1 dB, 20 Hz to 15 kHz, +1 dB, -3 dB, 20 Hz to 30 kHz, at 40 watts output into 8 ohms.	Like EM-200B, but measured at 60 watts output.
TOTAL HARMONIC DISTORTION (THD)	Less than 0.2%, @ 1 kHz (45 W/8 ohms); Less than 0.5%, 20 Hz to 20 kHz (45 W/8 ohms).	Like EM-100II, but measured at 65 watts output.	Like EM-100II but measured at 75 watts output.	Like EM-100II, but measured at 120 watts output.
INTERMODULATION DISTORTION (IM)	Less than 0.5%, 70 Hz & 7 kHz mixed 4:1 (25 watts into 8 ohms).	Like EM-100II, but measured at 35 watts output.	Like EM-100II, but measured at 40 watts output.	Like EM-100II, but measured at 60 watts output.
POWER AMP OUTPUT NOISE**	-40 dB* (MASTER VOLUME max.) (ONE INPUT VOLUME max.)	-38 dB* (MASTER VOLUME max.) (ONE INPUT VOLUME max.)	-37 dB* (MASTER FADER max.) (ONE INPUT FADER max.)	
PROGRAM BUS OUTPUT NOISE**	-44 dB* (MASTER VOLUME max.) (ALL INPUT VOLUME min.)		-48 dB* (MASTER FADER max.) (ALL INPUT FADER min.)	
EQUIVALENT INPUT NOISE** (UNBALANCED VERSION)	-118 dBm.			
EQUIVALENT INPUT NOISE** (BALANCED VERSION)	-118 dBm.			
MONITOR OUTPUT PERFORMANCE				
FREQUENCY RESPONSE	± 1 dB, 30 Hz to 15 kHz; +1 dB, -3 dB, 20 Hz to 30 kHz.			
TOTAL HARMONIC DISTORTION (THD)	Less than 0.2%, @ 1 kHz; Less than 0.5%, 20 Hz to 20 kHz, (at +10 dB* into 10 kohms).			
INTERMODULATION DISTORTION (IM)	Less than 0.5%, 70 Hz & 7 kHz mixed 4:1 (at +10 dB* into 10 kohms).			
EQUIVALENT INPUT NOISE**	-118 dBm.			
OUTPUT NOISE**	-71 dB*, Master volume at maximum & all Input volume controls at minimum; -64 dB*, Master volume and one Input volume control at maximum.			

*0 dB is referenced to 0.775 V RMS.

**Measured with a 6 dB/octave filter @ 12.47 kHz; equivalent to a 20 kHz filter with infinite dB/octave attenuation.

INPUT CHARACTERISTICS

Connection	Level Switch	Actual Load Impedance		For Use w/Nominal		Input Level		Connector in Mixer**
						Nominal	Max. Before Clip	
CHANNEL INPUTS (1-6, 8 or 12) (UNBALANCED VERSION)	-50*	LO-Z	HI-Z	LO-Z	HI-Z	-50 dB (2.5 mV)	-22 dB (6.2 mV)	XLR-3-31 and Phone jack (XLR is unbalanced)
	-40	1 kohm	20 kohms	150-600 ohms	3 k-10 kohms	-40 dB (7.8 mV)	-12 dB (193 mV)	
	-35*	1 kohm	20 kohms	150-600 ohms	3 k-10 kohms	-35 dB (14 mV)	-7 dB (346 mV)	
	-30	1 kohm	20 kohms	150-600 ohms	3 k-10 kohms	-30 dB (25 mV)	-2 dB (616 mV)	
	-20*	1 kohm	20 kohms	150-600 ohms	3 k-10 kohms	-20 dB (78 mV)	+8 dB (1.93 V)	
	+4	1 kohm	20 kohms	150-600 ohms	3 k-10 kohms	+4 dB (1.23 V)	+32 dB (31 V)	
CHANNEL INPUTS (BALANCED OPTION ON EM-150IIB, EM-200B, EM-300B)	-50*	LO-Z	HI-Z	LO-Z	HI-Z	-50 dB (2.5 mV)	-22 dB (6.2 mV)	XLR-3-31 and Phone jack (XLR is balanced)
-40	1 kohm	20 kohms	50-600 ohms	3 k-10 kohms	-40 dB (7.8 mV)	-12 dB (193 mV)		
-35*	1 kohm	20 kohms	50-600 ohms	3 k-10 kohms	-35 dB (14 mV)	-7 dB (346 mV)		
-30	1 kohm	20 kohms	50-600 ohms	3 k-10 kohms	-30 dB (25 mV)	-2 dB (616 mV)		
-20*	1 kohm	20 kohms	50-600 ohms	3 k-10 kohms	-20 dB (78 mV)	+8 dB (1.93 V)		
+4	***	20 kohms	***	3 k-10 kohms	+4 dB (1.23 V)	+32 dB (31 V)		
AUX IN (1,2 or L,R)		30 kohms		5 kohms		-20 dB (78 mV)	-	Phone jack
ECHO RETURN		30 kohms		5 kohms		-30 dB (25 mV)	-	Phone jack
GRAPHIC EQ IN (L,R)****		100 kohms		5 kohms		+4 dB (1.23 V)	+18 dB (6.2 V)	Phone jack
MONITOR SUB IN (1,2)		30 kohms		5 kohms		+4 dB (1.23 V)	+24 dB (12.3 V)	Phone Jack
POWER AMP IN (L,R)		30 kohms		5 kohms		N/A	+4 dB (1.23 V)	Phone jack

*EM-100II and EM-150IIB offer only these switch settings; EM-200B and EM-300B offer all settings except "-35".

**All connections are unbalanced; XLR CHANNEL IN connectors may be balanced (floated) with optional plug-in transformer modules (except EM-100II).

***Do not use LO-Z XLR Input when Input Level Switch is in +4 position and transformer option is installed; HI-Z phone jack input may be used.

****Not provided on EM-100II.

OUTPUT CHARACTERISTICS

Connection	Actual Source Impedance	For Use w/Nominal	Output Level		Connector in Mixer**
			Nominal	Max. Before Clip	
SPEAKER OUT (L,R)				8 ohms* W/ch TOTAL	
EM-100II	0.13 ohms	8 ohms	N/A	50 W 100 W	Phone jack
EM-150IIB EM-200B EM-300B	0.065 ohms	8 ohms	N/A	75 W 150 W 85 W 170 W 140 W 280 W	
LINE OUT (L,R)					
EM-100II EM-150IIB	390 ohms	600 ohms 10 kohms	0 dB (775 mV) +4 dB (1.23 V)	+14 dB (3.9 V) +18 dB (6.2 V)	Phone jack
EM-200B EM-300B	390 ohms	600 ohms 10 kohms	0 dB (775 mV) +4 dB (1.23 V)	+14 dB (3.9 V) +18 dB (6.2 V)	
MONITOR OUT (L,R)	390 ohms	600 ohms 10 kohms	0 dB (775 mV) +4 dB (1.23 V)	+14 dB (3.9 V) +18 dB (6.2 V)	
GRAPHIC EQ OUT (L,R)					
EM-150IIB	390 ohms	600 ohms 10 kohms	0 dB (775 mV) +4 dB (1.23 V)	+14 dB (3.9 V) +18 dB (6.2 V)	Phone jack
EM-200B EM-300B	390 ohms	600 ohms 10 kohms	0 dB (775 mV) +4 dB (1.23 V)	+14 dB (3.9 V) +18 dB (6.2 V)	
ECHO SEND	220 ohms	10 kohms	-20 dB (78 mV)	-6 dB (0.39 V)	
PHONES					
EM-100II	130 ohms	8 ohms	N/A	0 dB (0.775 V)	Phone jack (stereo)
EM-150IIB EM-200B	130 ohms	8 ohms	N/A	+2 dB (0.98 V)	
EM-300B	150 ohms	8 ohms	N/A	+2 dB (0.98 V)	

*Power output is measured at 1 kHz into specified load, both channels driven. The watts/channel figure is the output of one channel, whereas the total figure is the sum of both channels' power output.

**All connections are unbalanced.

Specifications subject to change without notice.

SECTION TWO Introduction

The Yamaha EM-100II, EM-150IIB, EM-200B and EM-300B are multi-input, stereo output mixers with built-in power amplifiers and Accutronics reverb units. They are compact and functional in design, with many full-performance features: switchable sensitivity, two-band equalization, pan pot and dual monitor sends on every input; separate master level controls; auxiliary

inputs and outputs; and graphic program equalization. Patchable inputs and outputs to each major function provide the flexibility of separate components with the convenience of one compact unit. Complete tonal control, substantial output power, tremendous versatility and proven Yamaha reliability make the EM-Mixers exceptionally good values.

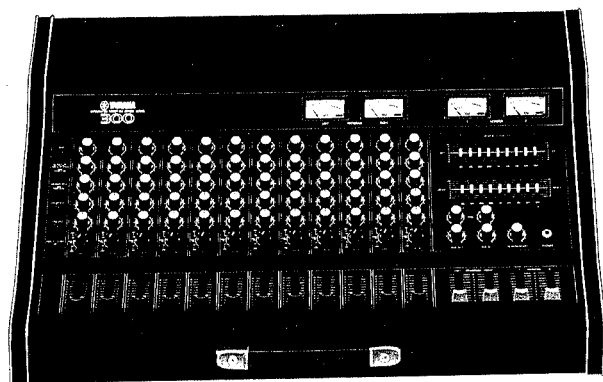

EM-300B

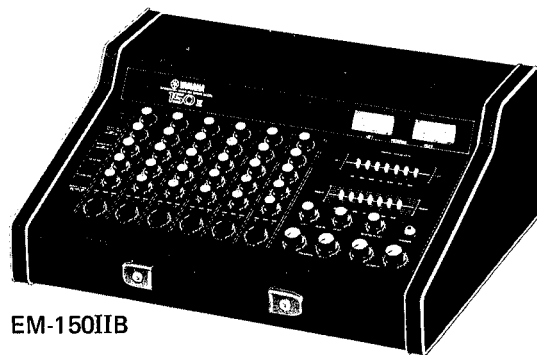

EM-150IIB

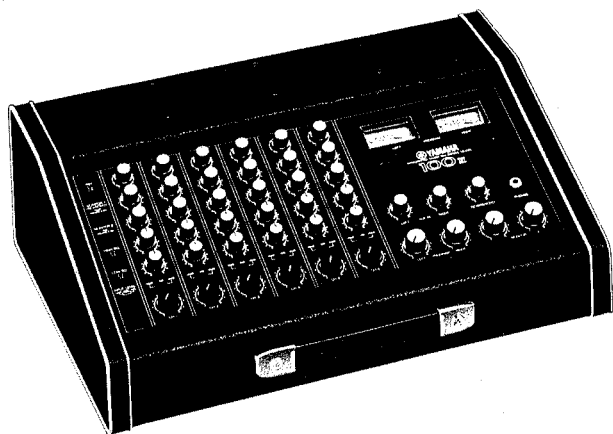

EM-100II

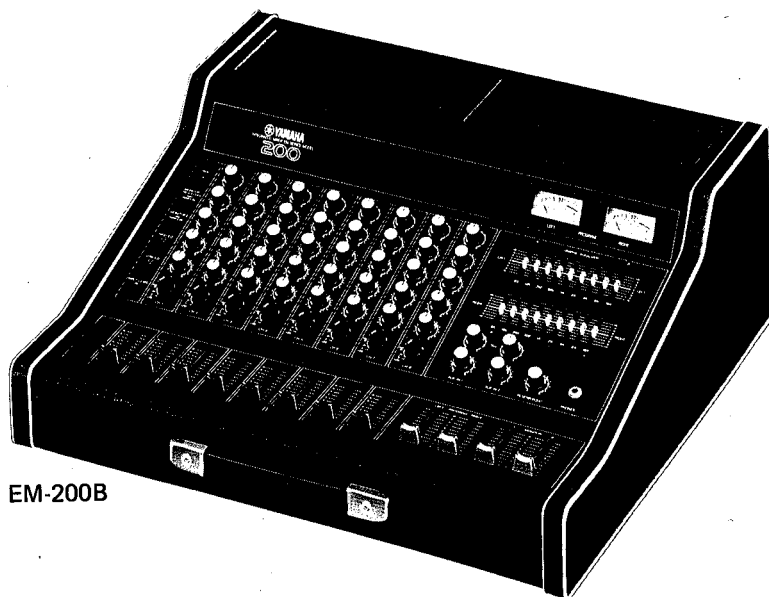

EM-200B

Inputs

The EM-100II and EM-150IIB each have 6 input channels, while the EM-200B has 8, and the EM-300B has 12 input channels. Each input channel includes the following controls: Fader, Hi-EQ, Low-EQ, Monitor 1 (which usually serves as the Reverb/Echo Send control), Monitor 2, stereo Pan, and an Input Level switch.

Auxiliary Inputs

All EM-Mixers have one stereo auxiliary input circuit (Aux In) plus three mono auxiliary inputs (Monitor Sub In 1, Monitor Sub In 2, and Echo Return).

Monitor & Speaker Outputs

The Monitor and Speaker Outputs are controlled by separate Master faders that independently adjust the level from the program and monitor mixing buses. The Speaker Output level is displayed by two VU Meters. (Monitor meters are also provided on the EM-300B.)

Linking Mixers & Recording

Two or more mixers may be linked or "chained" together to increase the total input capacity. For this purpose, the **Line Out** jacks of one mixer would be connected to the **Aux In** jacks of the next mixer. Alternately, the Line Out jacks may be used to feed a stereo tape recorder.

The Echo Send jack may also be used to feed a mono tape recorder, or other external device; this will not affect the function of the internal spring reverb.

Likewise, the **Monitor Out** jacks may be used to feed tape recorders, remote lines or other high-impedance devices. Remember that Monitor 2 does not reflect the program mix. It is fed "pre-fader and pre-EQ", so it can be mixed for its own unique channel-to-channel balance without regard to the stereo program mix.

Graphic Equalizers (Not on EM-100II)

The EM-Mixers' Graphic Equalizers are a unique tool, both for reducing acoustic feedback and for imparting limitless tonal characteristics to the Speaker outputs. Seven or nine linear controls "outline" any frequency response curve as it is created (hence, the term "graphic"). There are separate equalizers for each (Left and Right) program channel. The Graphic Equalizers do not normally affect the Monitor outputs, so corrections made for the "house" sound will not color the sound on stage. The Headphone jack does carry the graphically equalized program, as do the

G-EQ Output jacks, which can be used to drive external amplifiers. Alternately, the Monitor Outputs can be patched into the G-EQ Inputs, while the Line Outputs are fed to an external amplifier/speaker system.

Power Supply

The power supply is grounded and has convenient rear panel fusing for complete safety. The polarity-reversing power switch has two "ON" positions that help to minimize hum in certain instances. (Illuminated VU meters indicate that Power is "ON".)

Flexibility

The many inputs and outputs on EM-Mixers simplify set-up, increase their inherent flexibility, and safeguard against possible malfunctions by serving as alternate signal paths. If you're not sure whether a particular input or output is appropriate, try it, with this one warning:

CAUTION: NEVER PLUG THE SPEAKER OUTPUT INTO ANYTHING BUT A SPEAKER LOAD OR A DIRECT BOX MADE FOR HIGH POWER LEVELS, AND NEVER PATCH AN OUTPUT DIRECTLY BACK TO A CHANNEL INPUT UNLESS DIRECTED TO DO SO BY THIS MANUAL.

This simple precaution will protect your Mixers and related equipment — failure to observe this caution may void the Mixer Warranty.

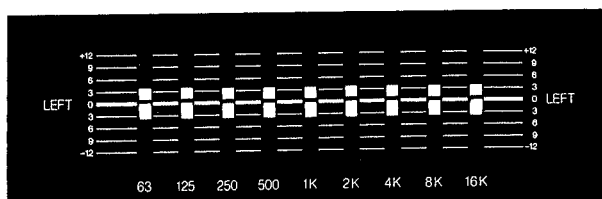
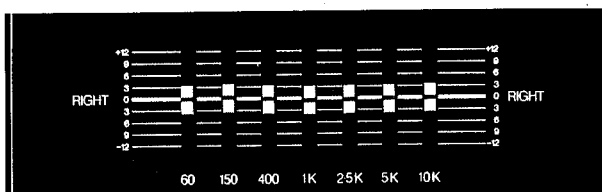

7 and 9 Band Graphic Equalizers

SECTION THREE

Detailed Instructions

The photos and callouts in Section I may serve as a useful reference while you read the following instructions. It also may be helpful to study the specifications, especially when considering how to use your mixer with an accessory device.

INPUT CHANNELS

Each channel has two input jacks. The standard phone jacks are intended for use with high impedance (Hi-Z) or low impedance (Low-Z) sources, while the 3-pin XLR connectors are strictly for low impedance inputs.

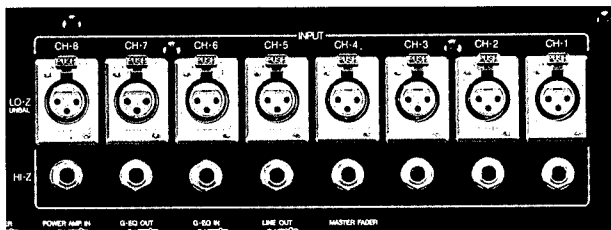

Input jacks

NOTE: Most Low-Z microphones (nominal 150 ohms) are designed to work into loads of approximately 900-1500 ohms. These load values are provided by the Low-Z XLR connectors, but not by the phone jacks. Connecting your Low-Z mics to the wrong input (High-Z) can alter the microphone's frequency response. Conversely, connecting a High-Z mic to a Low-Z input can overload the mic, lower the level and adversely affect the mic's frequency and transient response.

Input Level Switch

On the Models EM-100II and EM-150IIB, this is a 3-position slide switch, labeled MIC/INST/LINE.

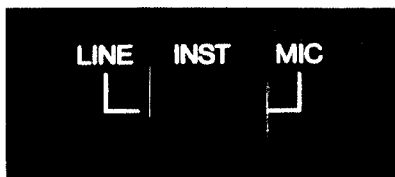

EM-100II & EM-150IIB input level switch

In **MIC** position, the channel input sensitivity (-50 dB) is optimum for a high-impedance microphone. The cables used with high-impedance (High-Z) microphones should be shielded, and no longer than 25 feet. If your application requires longer cables, we suggest the use of the optional Transformer Balancing Modules (not available for EM-100II) and low impedance microphones. Medium-impedance microphones, including many electret condenser microphones, can be connected directly to the Mixer without an auxiliary transformer, provided that the mic output level is sufficiently high.

In **INST** position, the channel's input sensitivity (-35 dB) is optimum for non-amplified instruments such as electric guitars or other instruments equipped with electro-magnetic pickups.

In **LINE** position, the channel's sensitivity (-20 dB) is optimum for "direct" or "preamp" outputs from amplified instruments like a synthesizer or electronic piano.

Input Level Switch

On the Models EM-200B and EM-300B, this is a 5-position rotary knob labeled for nominal input sensitivities of -50, -40, -30, -20, and +4 dB. The

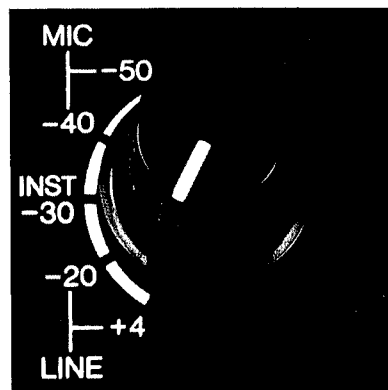

EM-200B & EM-300B input level switch

-50 dB setting is commonly used with low output dynamic microphones, -40 dB with medium output condenser microphones, -20 dB with electric instruments (preamplified) and low level (creative audio or hi-fi) line sources, and +4 dB with high level line sources (such as most professional equipment line outputs).

NOTE: The +4 position may not be used when the optional Transformer Balancing Module is installed.

Set the Input Level switch to correspond to the type of device that is plugged into the corresponding **Channel Input** jack. Here is one suggested procedure:

1. Connect all input sources to their respective channels. Plug in and wear your headphones to hear the program mix. **DO NOT CONNECT** any speakers yet.
2. Set all channel faders at zero (minimum). Set each channel Pan control all the way to the Left, and raise the Left Master Program fader to #9.

3. Start with the **Input Level** switch in the least sensitive position ("Line" or +4 dB). Bring the channel fader up to #7. If necessary, adjust the Input Level switch for greater sensitivity, one "click" at a time, until the input is clearly audible. The Left VU meter should peak around "0 dB". If the meter consistently shoots past "0 dB", or if the signal sounds distorted in your headphones, the Input Level switch is set for too much sensitivity (too low a dB #); decrease the input sensitivity (higher dB # on the Input Level switch) until the levels are correct.

4. Repeat the procedure for each input channel, until all channels are set for proper input sensitivity. Turn the Mixer Power OFF, and connect your speakers and outputs. Set both Master Program faders to about #7 and turn the mixer power ON again. You are now ready to adjust each channel fader, EQ, and stereo assignment (Pan).

CAUTION: DO NOT CONNECT THE SPEAKER OUTPUT OF ANY AMPLIFIER TO THE MIXER UNLESS A SUITABLE HIGH-LEVEL ATTENUATION PAD OR "DIRECT BOX" FIRST LOWERS THE LEVEL.

NOTE: Always turn Master faders (Program and Monitor) all the way DOWN before turning the AC Power ON.

The channel **fader** adjusts the level applied to the stereo program mix bus from whatever source is connected to the channel's input jack. This allows you to set precisely the level for various mics and/or instruments, thereby achieving just the desired mix (blend) of these sources.

The **Low-EQ** control adjusts the channel's frequency response through the low-frequency range. The control

has no effect ("flat response") when centered. Low-EQ boost (clockwise rotation) gives more "fullness" to vocals, guitars, etc., and more of a mellow character to horns and woodwinds. Low-EQ cut (counterclockwise rotation) removes boominess, avoids some of the excessive energy from drums, and reduces hum, rumble, and buzz. The **High-EQ** control adjusts the channel's frequency response through the high-frequency range. High-EQ boost (clockwise rotation) gives more "edge" or "bite" to string instruments, more "presence" to vocals, and more "attack" to percussive instruments. High-EQ cut (counterclockwise rotation) removes some of the breath sound from wind instruments, reduces guitar-string fingering sounds, lessens hiss, and avoids sibilant (lispy) vocal sounds. High-EQ cut also helps to make a performer sound farther away, particularly if reverb is added. Low and/or Hi-EQ cut can be helpful in avoiding feedback, too.

The **Monitor** controls determine the proportion of channel output that feeds each Monitor mix bus. **Monitor 1** feeds the bus which drives the Echo/Reverb effects (internal spring or external unit). The amount or "depth" of Echo/Reverb applied to the program is controlled by the **Master Echo/Reverb** control. The overall level of the Monitor 1 mix from all input channels, as applied to the Monitor 1 output, is controlled by the **Master Monitor 1** fader; this fader does not affect the Echo/Reverb level however, even though it is derived from the same mix bus.

The **Monitor 1** controls allow you to set a different mix for stage monitor speakers, or any other location away from the "main" speakers. The Monitor 1 mix is also subject to the settings of the channel fader and EQ controls.

The **Monitor 2** controls also let you create a separate mix, but one which is **not** affected by the channel fader or EQ controls. "Pre-fader" means that even after a channel is faded out completely, its input signal may still be heard at the Monitor 2 Output (at whatever level is set via the Monitor 2 channel and Master controls). "Pre-EQ" means that if Low-EQ or High-EQ have been used to alter the bass or treble tone of that input channel, the EQ will not affect the channel's contribution to the Monitor 2 Output. The pre-fader send on Monitor 2 is especially useful for feeding devices likely to have their own volume/EQ controls; such as external signal processors, remote mixing trucks, broadcast studios, or other mixing consoles.

The **Pan** control assigns the input signal to the Left and Right program mix buses, and thus pans the channel across the stereo perspective for the Speaker, Line, and G-EQ outputs; at 12 o'clock position ("0" on the Pan control scale), the signal is fed equally to the Left and Right sides of these outputs, and is thus "centered".

OUTPUT CHANNELS

The four **Speaker Output** jacks on each mixer are designed for 8-ohm or higher impedance speaker loads. The chart (next column) shows the nominal speaker power that each model EM-Mixer can deliver at the Speaker Output jacks with an 8-ohm load on each channel. Attention must be paid to choice of speakers; if a combined load of less than 8-ohms is connected to one channel via either or both of that channel's Speaker jacks, the amplifier will be overloaded. Overload might occur, for example, when two 8-ohm speakers, wired in parallel are connected to one Speaker jack, or when one 8-ohm speaker is connected to each jack of the Left or Right channel.

EM Mixer Model No.	Power Output 8-ohm load per channel
EM-100II	50 watts
EM-150IIB	75 watts
EM-200B	85 watts
EM-300B	140 watts

Power ratings are continuous RMS (or, more correctly, RMS voltage squared, divided by load impedance) at 1 kHz.

Power outputs of EM-Series II Mixers

Speaker cables should also be chosen carefully. While phone jacks are necessary, the coiled cords commonly used for guitars are **not acceptable**. In fact, the speaker cables need not be shielded. For short runs (under 25 feet), 18-gauge, or larger diameter wire may be used. For long runs (over 25 feet), 16-gauge or larger diameter wire should be used. (#18 or #16 AC "zip" cord, or similar cable, does a good job.) Be sure to use only high-quality phone plugs, and to check the cables for possible short-circuits before each use; an internal short-circuit or a cracked plug insulator will blow a fuse on the Mixer.

CAUTION: IF THE FUSE BLOWS AND THE AC MAINS ARE DELIVERING THE PROPER VOLTAGE, THE DIFFICULTY IS PROBABLY CAUSED BY EITHER A SHORT-CIRCUITED SPEAKER CABLE, A SHORT-CIRCUITED SPEAKER, OR USE OF A SPEAKER LOAD OF LESS THAN 4-OHMS IMPEDANCE. CORRECT THE CONDITION, AND ALWAYS REPLACE THE FUSE WITH ONE OF THE SAME RATING AND TYPE. LARGER FUSES DO NOT CURE PROBLEMS; THEY ONLY LEAD TO PERMANENT DAMAGE OF THE MIXER, AND WILL VOID THE WARRANTY.

A pair of VU Meters indicate the average power level at the Speaker outputs. Actual mix levels should average several dB below 0, with occasional peaks as high as 0 VU. Clipping distortion begins when the VU meter reaches full scale. The meters are illuminated, and the meter lamps also serve as AC Power pilot lights.

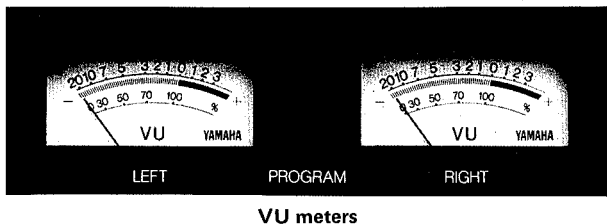

VU meters

The **Monitor Output** jacks are line-level, high-impedance outputs. They are designed to drive external monitor amplifiers, or they also may be used to make tape recordings. (Since one monitor output is pre-EQ & fader, and the other is post-EQ & fader, a true stereo mix would be difficult to achieve here.) The Master Monitor faders set the level at the Monitor Outputs, and are independent of Master Program faders. Inputs connected to the Monitor Sub In jacks will appear, but inputs connected to the Auxiliary Input jacks will not appear in the Monitor Outputs.

Master Controls

A special feature of the EM-Series II Mixers are the **Graphic Equalizers**. Seven sliders per channel on the EM-15011B and nine on the EM-200B and EM-300B alter the frequency response of the Mixer's Left or Right Program outputs. These sliders differ from the channel EQ controls in that each operates over a limited range of frequencies. (One-octave band centers on the EM-200B and EM-300B.) Each G-EQ slider is center detented; it "clicks" at the center ("flat") point of its boost/cut range. These equalizers provide far more flexibility than typical tone controls. Acoustic feedback can be reduced by lowering the slider which covers the frequency range where the feedback occurs. Feedback frequencies can be estimated by comparing them to notes on a piano or other instrument ("middle C" is 256 Hz, one octave above is approximately 512 Hz, etc.).

furniture, etc. Since absorptive materials affect mostly the high-frequencies, the sound may be too mellow or bassy. Other rooms with very hard walls and ceilings, or hard surfaced dance floors, may sound too bright. Or perhaps the speaker system is deficient in one frequency band yet is peaky in another band. Adjusting the Graphic Equalizer can compensate partially for these problems in a way that would be difficult to achieve with input channel EQ controls.

The Graphic Equalizers may also be used for many special effects. As with any equalizer, greater amounts of boost or cut cause greater phase shift. Therefore, use graphic equalization sparingly; extreme settings should be reserved for solving severe problems or for special effects. To keep distortion at a minimum, avoid excessive boost at a single frequency. Since removing feedback frequencies with the Graphic Equalizers can also remove portions of desirable program material, you should first attempt to solve feedback problems by careful speaker and microphone placement.

The G-EQ In and Out jacks on the rear panel allow you maximum flexibility in using the Graphic Equalizers. For example, the diagram below shows how you can assign one Graphic Equalizer to both program channels (when a mono program is all you need) using a "Y" cord, and then take advantage of the other Graphic Equalizer for the Monitor 1 mix.

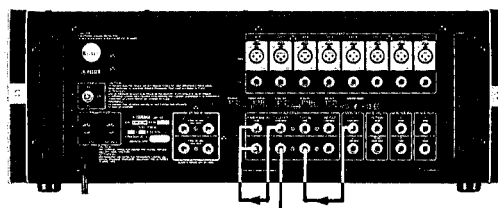

"Y" Adapter ↗

Note:
Connect house speakers to "speaker" jacks.

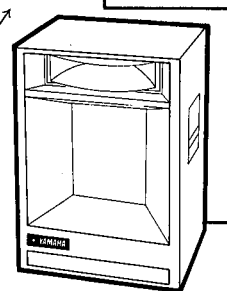

A4115H
Monitor
Speaker

G-EQ alternate patching for monitors and house. Not applicable to Model EM-100II.

The **Left and Right Master Program Faders** simultaneously adjust the program level at the Speaker, Headphone, Line, and Graphic-EQ outputs. These controls operate normally at about #7. Frequent mixing with the Master Faders at maximum indicates that the individual channel faders may be set too low, that the channel Input Level switches are set incorrectly, that the input sources are of insufficient level to drive the Mixer, or that the Mixer's amplifier is not powerful enough to deliver the acoustic levels you want. In the later instance, you could use additional power amplifiers and speakers (driven from G-EQ out), or you could use more efficient speakers.

The **Master Monitor Faders** (1 & 2) adjust the program level at the respective **Monitor Outputs**.

The **Aux In Volume** controls affect how much of the Aux In signal is fed to the program mixing buses.

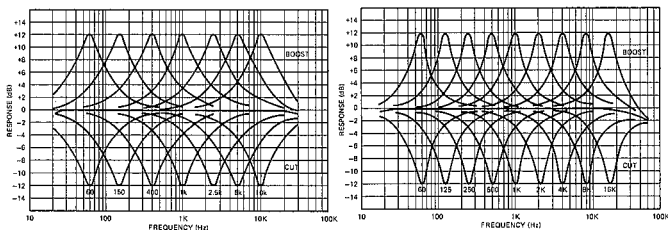

EM-15011B

EM-200B & EM-300B

Feedback control is actually a minor application for the Graphic Equalizers. Judicious use of the Equalizers can help the PA system sound more natural in troublesome acoustic environments, and can add desired color, warmth or penetration even in good acoustic environments. For example, some clubs have large amounts of sound-absorbing carpeting, draperies,

The **Master Program Faders** also affect the Aux In signal level, as well as the program mix from the input channels. In practice, the Aux In Volume controls determine the proportion of the Aux In signal to the mixed signal from the input channels. On the EM-100II and EM-150IIB, the incoming Aux signals are fed directly to the Left and Right program buses. The EM-200B and EM-300B also have **Aux Pan** controls which position each incoming Auxiliary signal left-to-right in the stereo perspective. Note that the Aux signal does not appear in the Monitor outputs.

OTHER FEATURES

To use an external reverb or echo device, connect the Mixer's **Echo Send** jack to the input of the external device, and connect the output from that device to the mixer's **Echo Return** jack. Operate the Mixer's Reverb/Echo controls normally. Other types of accessory devices such as tremolo, phase-shifters, digital delays, or "pedal devices" may be connected between the Echo Send and Echo Return jacks for special effects, so long as the levels are compatible.

The nominal output level at the Echo Send jack is -20 dB. The nominal input sensitivity at the Echo Return jack is -30 dB. While these are commonly used operating levels, there are reverb, echo and delay devices available that are designed to operate at lower and/or higher nominal levels. A device designed to operate at guitar pickup (i.e. very low line) levels may be overdriven by the Echo Send jack, causing distortion, or may have such a low-level output (below -30 dB) that it will produce excessive noise in the Echo Return circuit. Such a device should probably be connected between the instrument and the Mixer's input channel. A device designed to operate at high line levels (say -10 to $+4$ dB) may not be adequately driven by the Echo Send jack, or may produce an output that overdrives the Echo Return jack and causes distortion in the Mixer. This type of device may be driven from the Monitor 1 output which has a nominal $+4$ dB level. If the nominal output level of the device is only slightly higher than the -30 dB sensitivity of the Echo Return jack, return the effects to the Echo Return jack, and lower the level with Master Reverb/Echo. If the output level is too high for this jack, the effects may be returned through an unused input channel; in this case the selected input channel's Monitor 1 Send must be kept **closed** to avoid feedback.

The internal spring reverb is disconnected from the program whenever a plug is inserted in the Echo Return jack. To patch the Mixer for use of the internal reverb device **and** an external device, connect the mixer's Echo Send jack to the input of the external device and connect the output of that device to the mixer's **Aux Input** jacks. With the EM-200B or EM-300B, the Aux Pan controls may be used to position the mono external signal in the stereo mix. With the EM-100II or EM-150IIB, a "Y"-adapter cable allows a mono reverb or echo unit to feed both Aux In jacks. You can then fade out the external Echo using the Aux Volume control(s) and fade in the internal reverb with the Master Reverb/Echo control - or vice versa. If you like the effect of both devices together, you can mix them by bringing up both the Aux volume and Master Reverb/Echo controls.

The **Line Out** jacks are line-level, high-impedance outputs for feeding additional power amplifiers, tape recorders, delay lines, or other devices with high-impedance, line-level inputs. The Line Out jacks are

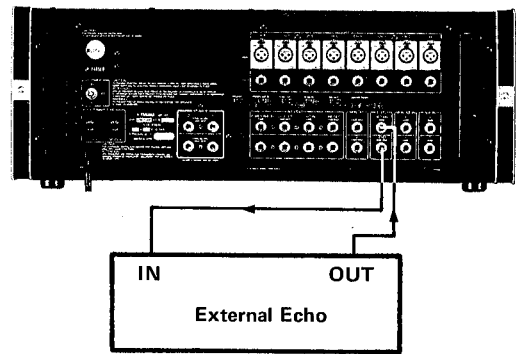

Use of external echo device only. (Built-in reverb automatically disconnected.)

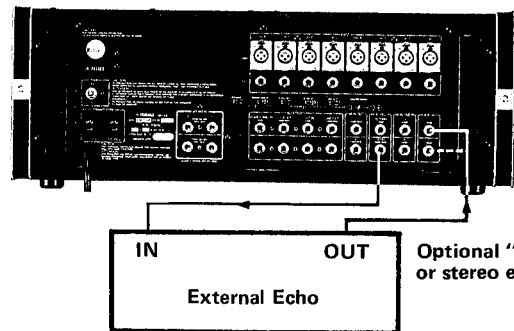
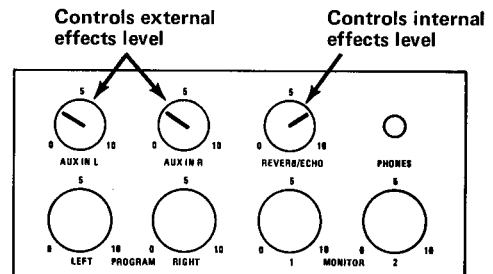

Use of **BOTH** internal reverb and external echo device. (Alternately or simultaneously)

controlled by the Master Program Faders, but are independent of Master Monitor Faders and Graphic Equalizers.

WARNING: SEE CAUTIONS ON PAGES 5, 10, and 11.

AC Power

Connect the AC Power Cord of the Mixer to any 110 V to 120 V AC, 50 Hz or 60 Hz grounded (three-wire) outlet. The mixers will draw the following maximum Power from the AC mains:

EM-100II:	140 Watts
EM-150IIB:	170 Watts
EM-200B:	290 Watts
EM-300B:	400 Watts

For maximum protection each mixer is **Fused**. If a fuse blows, replace it with another of the same size and type. Repeated fuse failures suggest a problem with the Mixer, speaker lines, auxiliary equipment, or power lines. Check the speaker lines for shorted circuits or too low impedance; measure the power line voltage and frequency with all equipment Power ON; if these meet the listed specifications, consult a qualified repair technician.

SECTION FOUR Applications

Club Sound Reinforcement (PA) System

The EM-Mixers are ideal for use as the main audio control board in a typical nightclub sound system. The diagram shows connections for one of the thousands of possible setups. Shown are microphones for vocals and each instrument's amplifier, a keyboard patched directly into the Mixer (no amplifier), and submixing using Yamaha's Model PM-170, a high-impedance, rack-mountable mixer. (The submixer is used to obtain additional inputs, and may be used to pre-mix groups of instruments such as drums or several keyboards, before feeding the EM-Mixer.)

Cables from high impedance microphones or high impedance instruments should be limited to 25' maximum length to avoid high frequency losses and excessive hum or noise. To take advantage of low impedance lines and microphones with an EM-Mixer, you can use optional "Transformer Balancing Modules" (Except EM-100II) or connect in-line matching transformers. For low impedance submixing use Yamaha's Model PM-180 (a low-impedance rack-mountable mixer).

The nightclub sound system illustrated here uses an external echo device, connected between the Mixer's Echo Send and Echo Return jacks. Other types of accessory devices may be connected between these jacks, as explained in Section III.

A stereo tape recorder may be used in this system both for music playback during set-up and intermissions, and for live program recording. The outputs of a recorder normally would be connected to the EM-mixer's Auxiliary inputs, or, if a submixer is in use, the recorder outputs can be patched to the submixer's

aux inputs (as shown). Either approach permits tape playback without tying up an input channel on the EM-Mixer. To record live stereo program material, the Line Outputs from the EM-Mixer would be patched to the record inputs of the tape machine.

Alternately, for a mono program, the EM-Mixer's Monitor 2 Output could be connected to the recorder's input(s). This would send a pre-EQ/fader mix to the recorder, allowing you to set a different mix for the recording than for the house PA. If, for example, the on-stage instrument amplifiers were loud in the house you could keep their mix levels very low in the PA speakers, but you could pull those channels up in the recorded mix.

Any high-quality 4- or 8-ohm speaker system may be used with the EM-Mixer, provided that the speakers' power capacity is compatible with the output power of the Mixer (See page 11). Each main speaker in this nightclub example is a Yamaha Model S4115H, chosen for its high efficiency, controlled dispersion, and natural sound. The S4115H has a 15" low-frequency woofer housed in a combination front-loaded horn/ducted-port bass reflex enclosure. Its high frequency section consists of a compression driver and radial horn.

Yamaha Model A4115H speakers are shown as stage monitors, a good choice due to their built-in 100 Watt power amplifiers. Alternately, S0112T, S2115H, S0110T, or other speakers which do not have built-in power amplifiers can be used with a separate power amplifier such as the Yamaha P2050, P2100 or P2200.

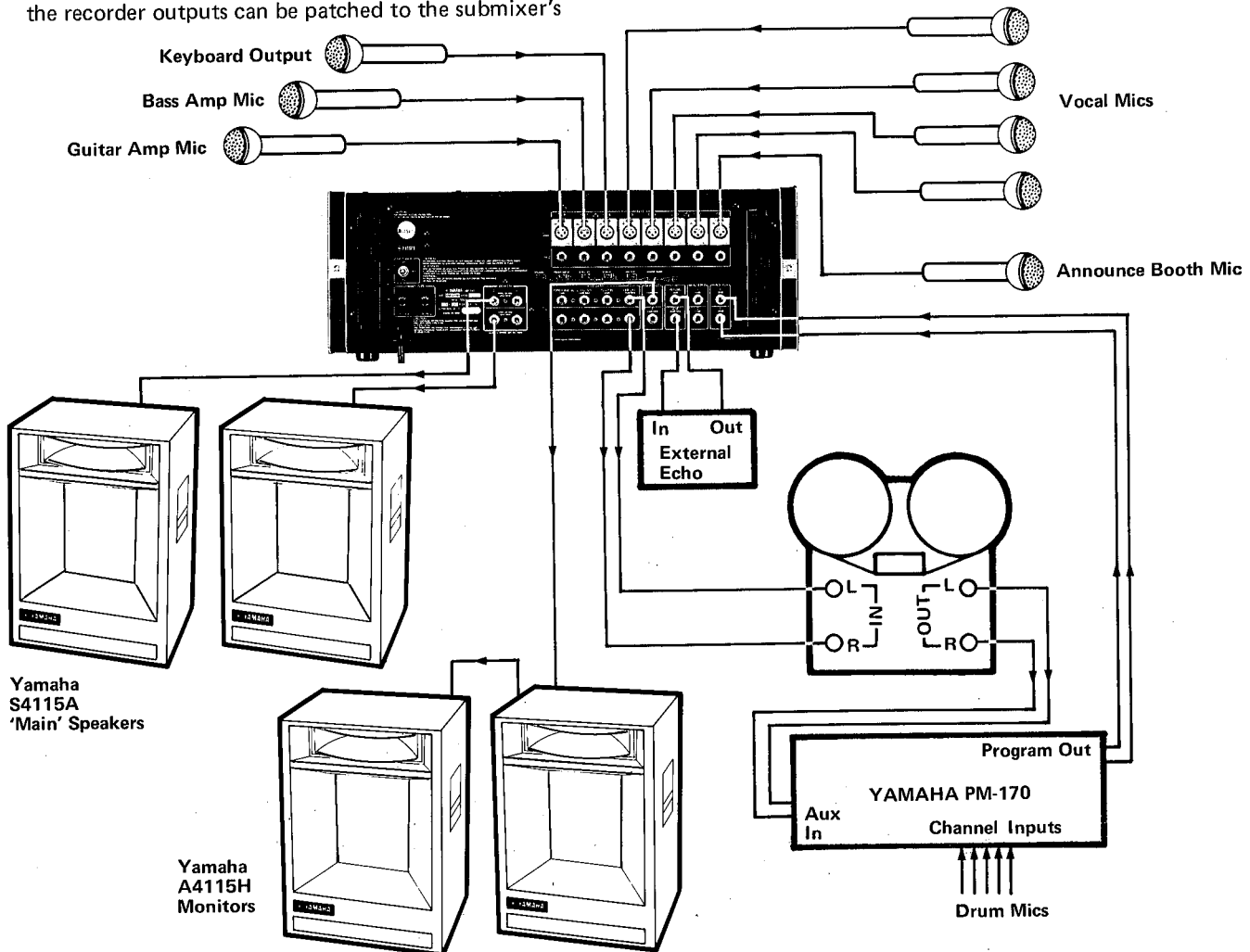

Instrument Mixer

Contemporary musicians often use a multi-instrument approach to achieve a variety of sounds and effects. The diagram shows a typical setup for a player using several keyboards and mixing them on stage with the EM-100II mixer. Also illustrated are feeds to the house mixing console, and a Yamaha S4115H speaker system used as a stage monitor. By adjusting the individual channel Pan controls, the performer can feed two subgroups to the house mixer, or one stereo mix if his instruments require. (Note: When mixing live on stage in this manner, the performer would control the sound he hears on stage by changing the **Monitor 1** controls. The channel faders would be pre-set during the sound check for optimum main house mixing levels.) The Input Level switch should be set to the proper position for the input sources in each channel (See page 10). The overall setup would be similar for a guitarist or other musician.

The mono output of a stereo instrument can be connected to any channel input on the Mixer. To use the mixer's full stereo capabilities with a stereo instrument, connect the left and right outputs of the instrument to two of the Mixer's channel inputs. Then set one Pan control fully "Left" and the other fully "Right" or, for less separation, set the controls more toward center. Special effects can be added by adjusting the EQ and Reverb/Echo controls on the two channels differently. To gain an additional stereo input, connect your line-level stereo instrument to the Mixer's Auxiliary Inputs; an instrument or other source connected to the Auxiliary Inputs will not appear in the Mixer's Monitor or Echo Send Outputs.

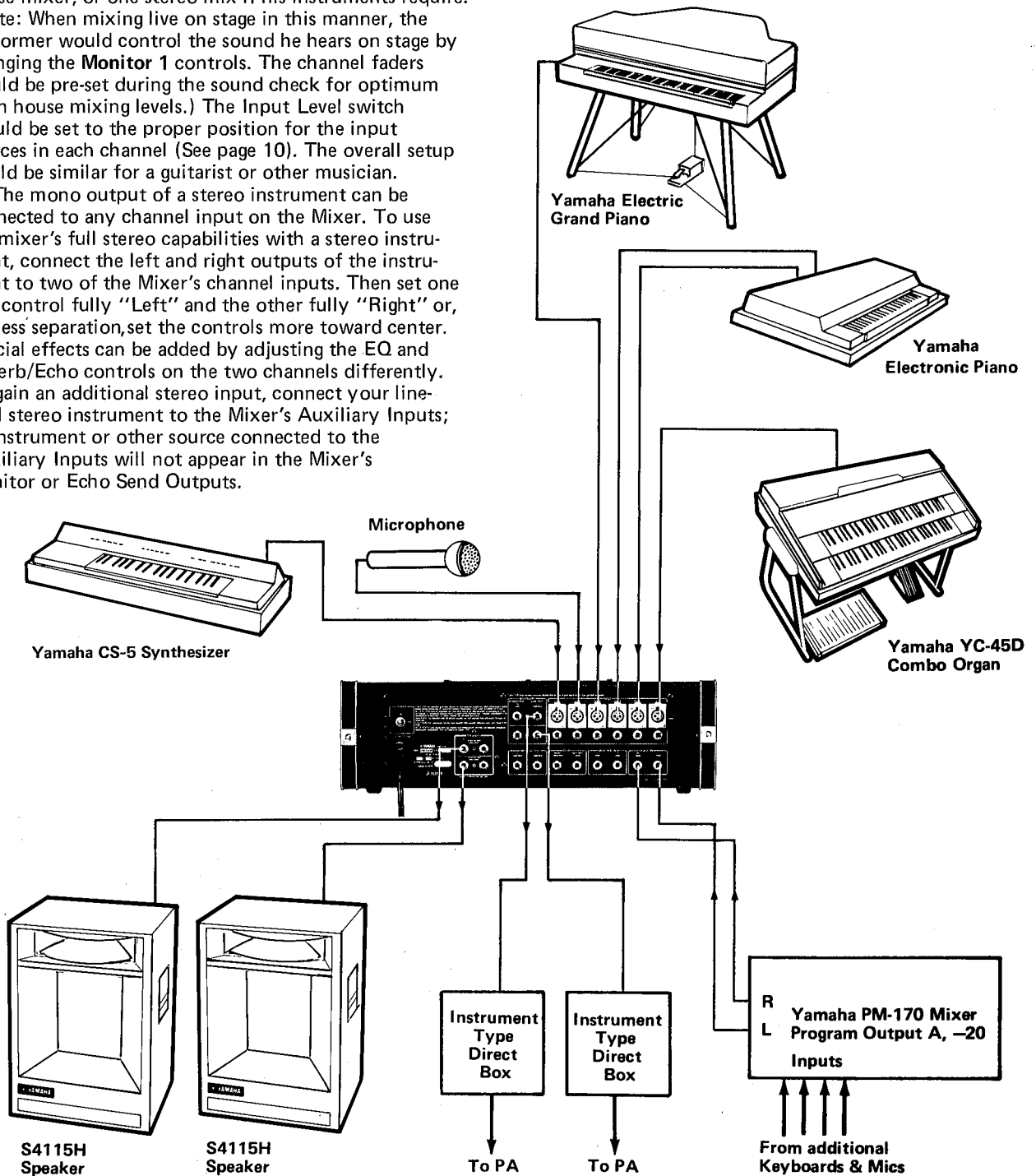

Other Reinforcement Uses

The EM-Mixers can be used successfully in a wide variety of sound reinforcement applications. Combined with a pair of Yamaha S0112T or other compact speaker systems, and a roll-around podium, an EM-Mixer makes a great portable sound system for a school, library, banquet hall or meeting room. Plug the line-level sound output from a portable film projector into one channel, and adjust the Input Level switch to suit the projector's output level. Connect microphones and/or a tape recorder's Play outputs (line out) to other input channels, and adjust each for the best tonal qualities.

The flexibility and economy of the EM-Mixers make them attractive for permanent installations, too. Use connections similar to those diagramed for Club Sound Reinforcement Systems. These mixers are especially useful for permanent multi-projector/recorder setups (like slide, 16mm film, and filmstrip with additional cassette and reel-to-reel audio sources). To minimize hum and high-frequency losses, avoid long microphone cables, or use low-impedance microphones with the optional "Balancing Transformer Modules" on the EM-1501B, EM-200B, & EM-300B; or use in-line matching transformers. Always use heavy gauge speaker cable, and keep microphone, speaker, and AC power lines well separated.

You can feed another PA system (one with low or high impedance inputs) from the EM-Mixer's Line Outputs or its Monitor Outputs. For a mono feed to a PA system with a low or high impedance input, use either Monitor Output. If you want a balanced feed to a remote mixer, use a "direct box," or a transformer.

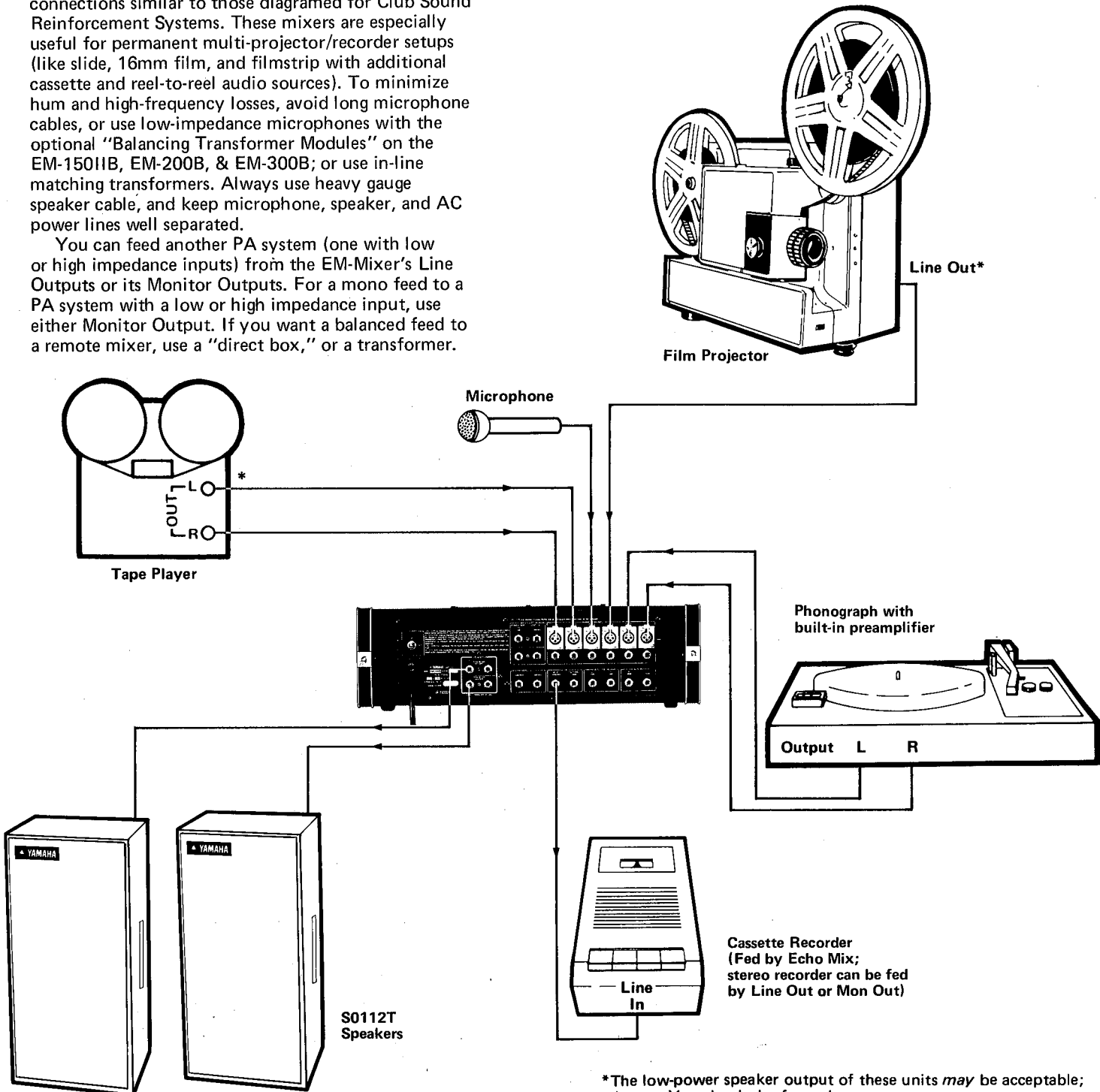

*The low-power speaker output of these units *may* be acceptable; ask your Yamaha dealer for assistance.

Submixing with Two EM-Mixers

There are several ways to connect two EM-Mixers together. One easy method allows all the channel inputs of each Mixer to feed both the Monitor and Speaker outputs.

To accomplish this:

1. Plug the Line outputs of Mixer 1 into the Aux Inputs of Mixer 2.
2. Plug the Monitor Outputs of Mixer 2 into the Monitor Sub Inputs of Mixer 1.
3. Patch the Monitor Outputs of Mixer 1 into the G-EQ Inputs of Mixer 1.
4. Plug the main speakers into the Speaker Outputs of Mixer 2, and the monitor speakers into the Speaker Outputs of Mixer 1.

All channels of each mixer can now feed both the monitors and main speakers. Overall monitor levels are now controlled with the Master Monitor faders on Mixer 1, and overall program levels are controlled by the Master Program Faders on Mixer 2.

This method facilitates the use of "subgroups" for easier mixing. For example, if you use an EM-15011B for Mixer 1, and an EM-300B as Mixer 2, you could send your vocals and percussion into Mixer 1, and all other instruments into Mixer 2. By Planning all vocals in Mixer 1 full left and all percussion full right, you

would be sending separate and complete vocal and drum mixes to the Master Aux controls of Mixer 2. Using the **Aux Pan** controls on Mixer 2, you can then position the vocals and the drums independently anywhere in the stereo perspective. This allows you to vary the level of all vocals or all the drums, simply by varying the Mixer 2 Master Aux In 1 and 2 controls. Similarly, the Master Program Faders on Mixer 1 now serve as a subgroup for all Mixer 1 inputs feeding the Program outputs, and the Master Monitor faders on Mixer 2 now serve as subgroups for all inputs on Mixer 2 being fed to the monitors.

An additional advantage in this example is the ability to use Graphic Equalizers for each channel of both the main and monitor speakers, with different EQ for each.

CAUTION: Use extreme caution when connecting two mixers. Be certain that you patch connections so that no output can be fed to an input which would again be fed to the same output. In some instances the setting of a channel mix or monitor send control may be the key to avoiding this situation. Should you allow an output-to-input loop to occur, the result will be feedback (howling), oscillation, and possibly severe damage to the Mixer or other sound system components. Yamaha is not responsible for any such damage due to negligent or improper use, and such use may void the Warranty.

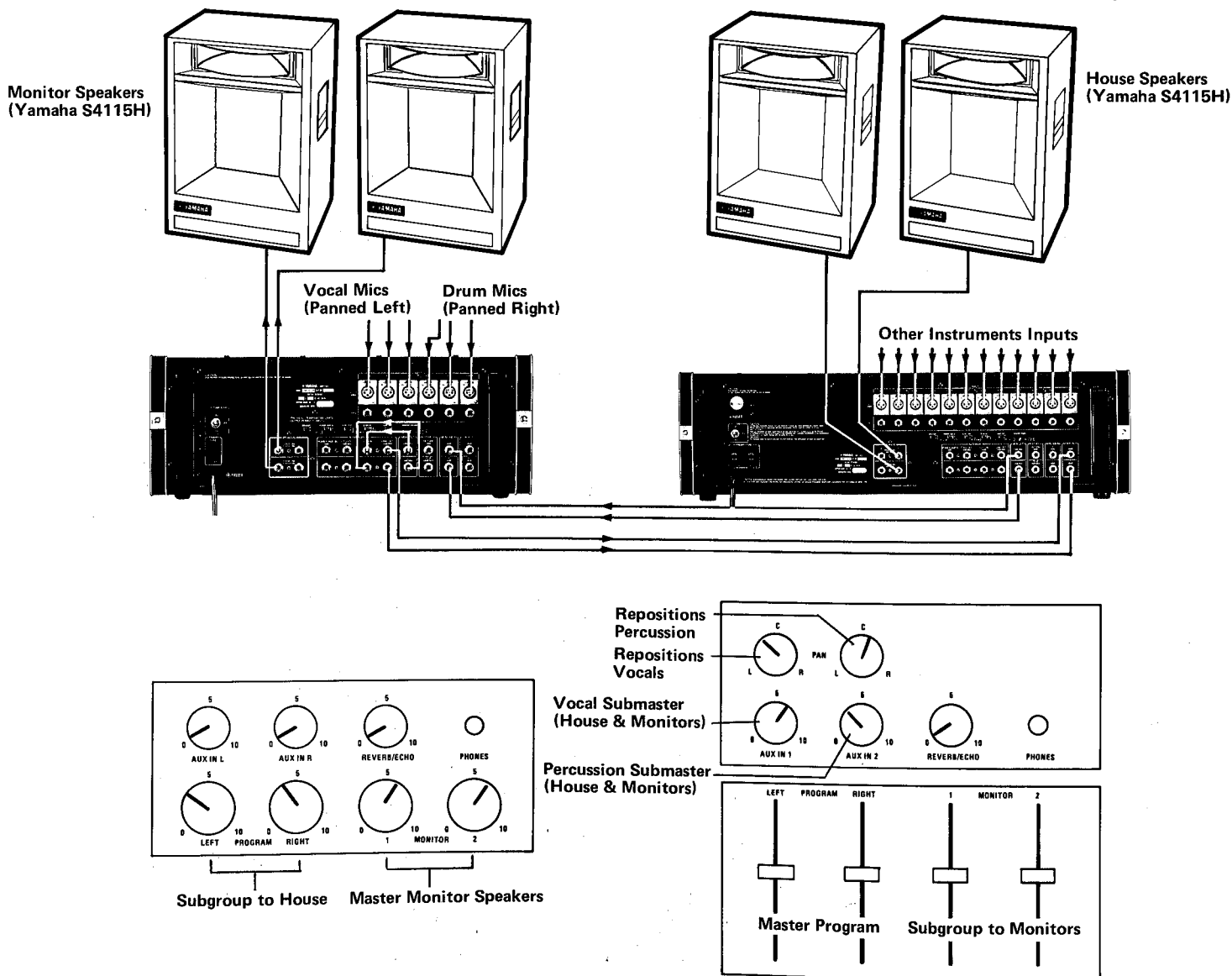

Recording

When the Mixer is being used for vocal or instrument mixing, its Line Outputs can feed a tape recorder, or the inputs of a professional recording console. All EM-Mixers work well for on-site recording.

The diagram shows one possible setup for tape recording. Two Yamaha S4115H speakers serve as monitors. To use the EM-Mixer for recording, operate its Channel Inputs normally and feed the Left and Right Line Outputs to the tape recorder's line inputs. Connect the tape recorder's line outputs to the Mixer's Left and Right Auxiliary Inputs. (Keep Aux Volume at zero while recording . . . trying to monitor the tape as it is being recorded will create feedback.) For playback, fade the Aux In controls up to a comfortable listening level.

Broadcast Production

The EM-Mixers can be used for broadcast studio production, or for location work. The input channel flexibility allows the engineer to use mics, tape machines, or external phono preamps. The announcer can use the Monitor 2 (pre-fader) Output for previewing a mono mix, and the Left and Right Line Outputs for a program feed. Alternately, the Monitor 2 Output may be used to feed a mono program to the transmission or recording point, with the Speaker outputs used as control room and/or studio monitors.

Maintenance

When operating your EM-Mixer, never cover the air vents on the top or bottom panel. Constricting the air flow through these vents may cause overheating and damage to the mixer.

The use of solvents for cleaning the front panel may cause discoloration. Dust the panels and control knobs with a soft cloth; use a damp sponge with a mild dish detergent if necessary.

Your EM Series II Mixer is an integrally-designed unit. It requires no regular maintenance, other than common sense and reasonably careful handling. Should a problem develop within the Mixer, refer servicing to an authorized Yamaha M.I. dealer or service center.

If you encounter other problems like no Echo, output on only one channel, Monitors or Sepaker outputs only working on one jack, etc.; re-check all input/output connections, pan controls, and the channel and master faders. Also, see the troubleshooting chart on page 20.

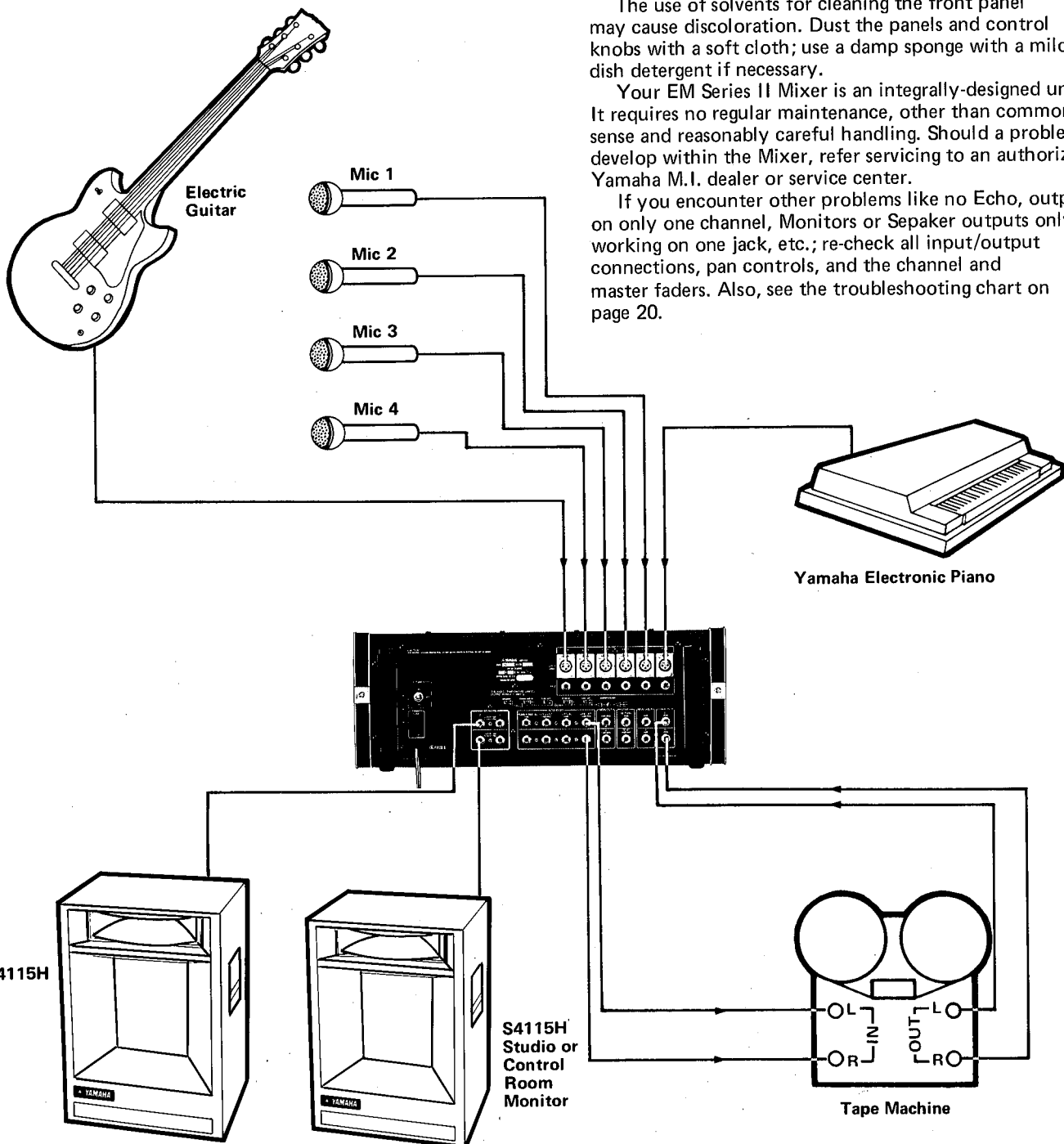

SECTION FIVE

Balanced Input Transformer Modules

Installation instructions for balanced input transformer modules or Yamaha EM-150IIB, EM-200B and EM-300B.

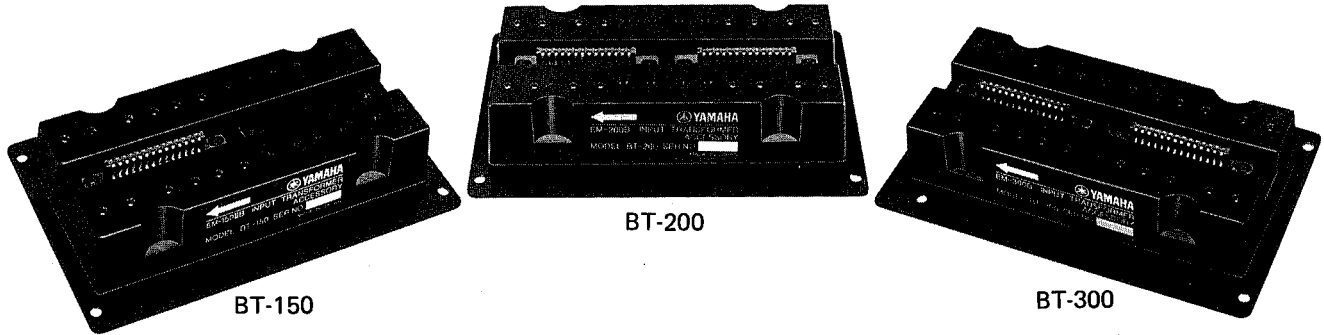

PARTS IDENTIFICATION

Model BT-150: 6-channel balancing transformer module for EM-150IIB mixer.

Model BT-200: 8-channel balancing transformer module for EM-200B mixer.

Model BT-300: 12-channel balancing transformer module for EM-300B mixer.

NOTE: A Model BT-150 may be used to balance the first 6 inputs of a Model EM-300B; refer to the Special Instructions after the General Installation Procedure.

GENERAL INSTALLATION PROCEDURE

1. Set the mixer down on a suitable work table. The unit should be vertically oriented, resting on the rear-panel power cord holder brackets. Orient the mixer so its bottom panel is facing you.
2. Remove the 4 phillips head screws that secure the transformer compartment access cover, and set the cover aside. (Refer to Figure 1.)

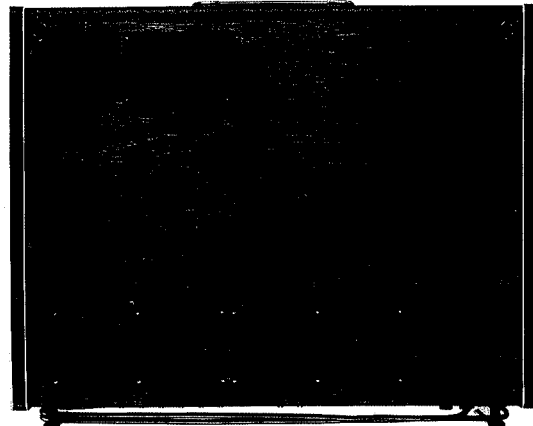

Figure 1 (EM-300B)

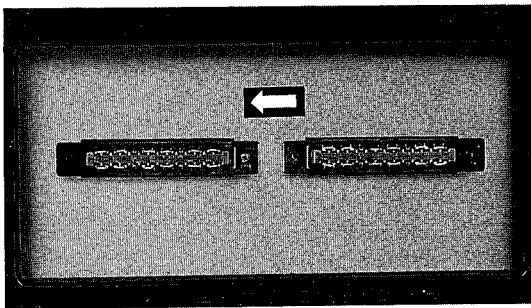

Figure 2A

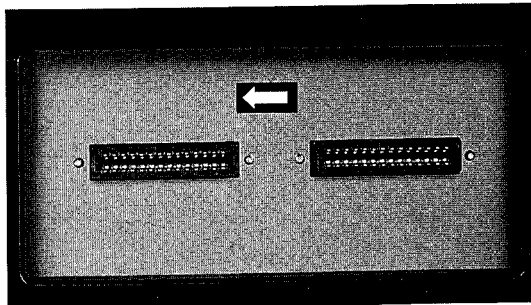

Figure 2B

3. Remove the 28-pin jumper connectors* from their sockets in the compartment. Save these connectors in case you later wish to return the mixer to the unbalanced configuration. (Refer to Figures 2A and 2B.)

*The EM-150IIB has only one jumper connector.

NOTE: The 28-pin sockets are intentionally mounted loosely so they "float", allowing for self-alignment when the transformer module is installed. **DO NOT ATTEMPT TO TIGHTEN THE SOCKET MOUNTING SCREWS.**

4. Hold the balancing transformer module so its connectors face the mixer. The module's label should be on the top, and its arrow should be pointing in the same direction as the arrow in the connector compartment (i.e., to your left). (Refer to Figures 3A and 3B.)



Figure 3A (EM-150IIB and BT-150)



Figure 3B (EM-300B and BT-300)

5. Press the module firmly onto the socket(s) within the transformer compartment.
6. Replace the 4 phillips head screws, removed in step 1, to secure the module to the mixer. (Refer to Figure 4.)

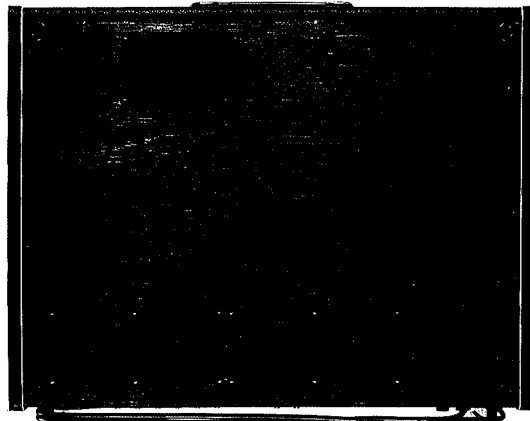

Figure 4 (EM-300B)

NOTE: The bottom right-hand screw set in approximately 1/2" to the left of the module's bottom right corner to ensure proper orientation of the BT- module.

7. Return the mixer to its normal upright position, and apply the "LO-Z BAL/HI-Z" sticker provided with the transformer module. The sticker should be placed on the mixer's rear panel, to the left of the input connectors, so it covers the original nomenclature.

SPECIAL INSTRUCTIONS: BALANCING HALF OF AN EM-300B

If you require a maximum of 6 balanced inputs on an EM-300B mixer, you can install a BT-150 transformer module instead of the BT-300 module.

1. Set the EM-300 down on a suitable work table, and remove the transformer compartment access cover as described in Steps 1 and 2 of the preceding instructions.
2. Remove only the left-hand jumper connector from it, socket in the transformer compartment. (Refer to Figure 7.)
3. Remove the two screws that secure the small "blind plate" adjacent to the connector in the BT-150 module, and set the plate and screws aside. The resulting opening in the module provides clearance for the righthand jumper connector which remains in the mixer. (Refer to Figures 5 and 6.)

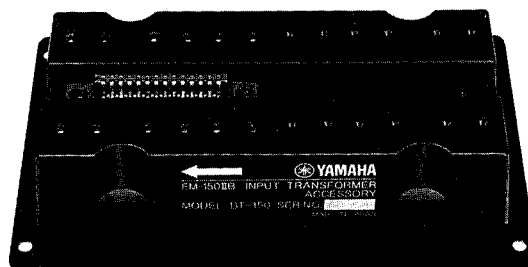

Figure 5 BT-150 (with blind plate installed)

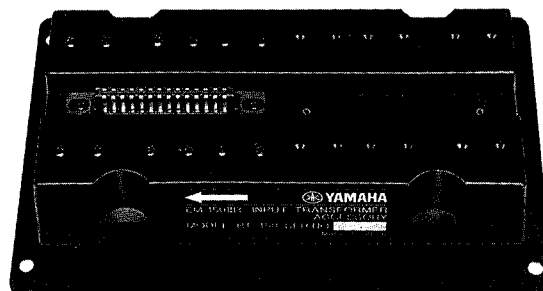

Figure 6 BT-150 (with blind plate removed)

4. As in the preceding instructions, align the arrow on the BT-150 with the arrow in the transformer compartment, and insert the module firmly onto the connector socket. (Refer to Figure 7).
5. Replace the 4 phillips head screws, removed in step 1, to secure the module to the mixer. (Refer to Figure 4.)

NOTE: The bottom right-hand screw set in approximately 1/2" to the left of the module's bottom right corner to ensure proper orientation of the BT- module.

6. Channels 1 through 6 now have balanced "LO-Z" inputs. Channels 7 through 12 remain as they were, with unbalanced "LO-Z" inputs. It is advisable to label the mixer's rear panel accordingly.



Figure 7

WARNING REGARDING OPERATION WITH BALANCED INPUTS

When an EM mixer's input has been balanced by installation of any BT- transformer module, the "+4" position of the Input Level switch should no longer be used for signal sources plugged into the channel's "LO-Z" XLR

input. This precaution is necessary to prevent transformer saturation and consequent distortion. The "+4" setting may be used for signal sources plugged into the channel's "HI-Z" phone jack input.

RESTORING A TRANSFORMER BALANCED MIXER TO UNBALANCED OPERATION

The procedure for restoring an EM mixer to its original unbalanced configuration is the opposite of that for installing the BT- transformer module. When removing the BT-

module from the mixer, be sure you withdraw only the 4 outermost phillips head screws; the other 4 screws hold the module together.

Block Diagrams

EM-100II BLOCK DIAGRAM

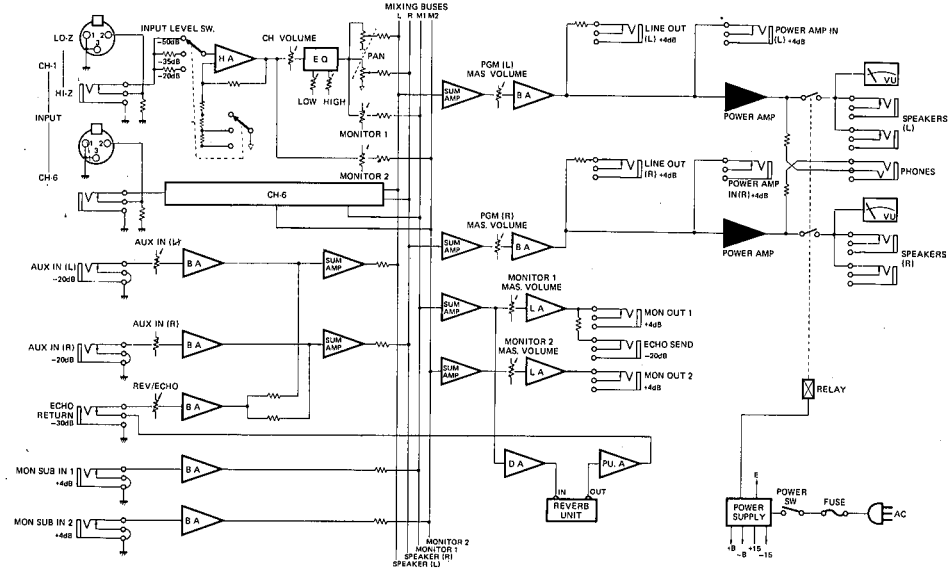

EM-150IIB BLOCK DIAGRAM

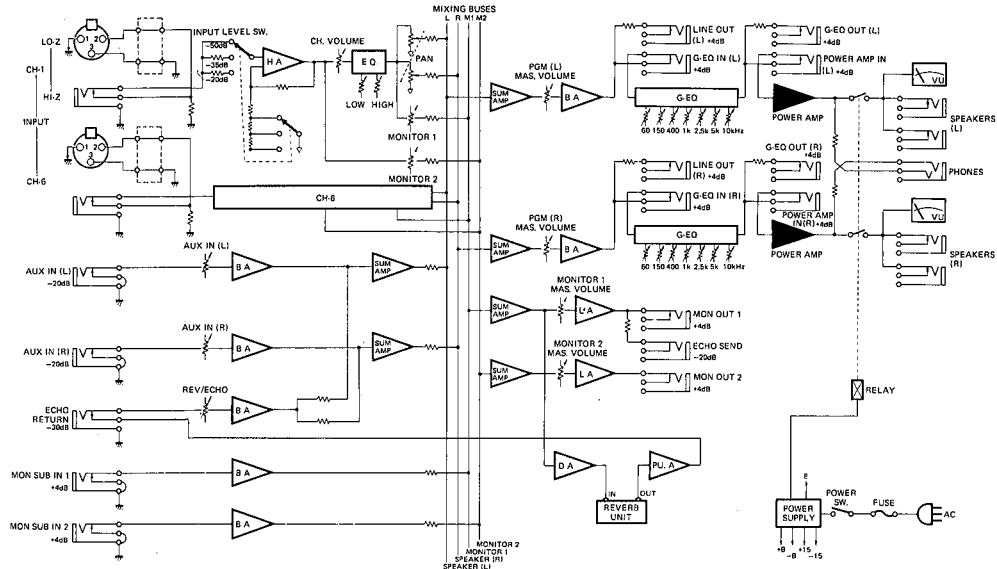

EM-200B/300B BLOCK DIAGRAM

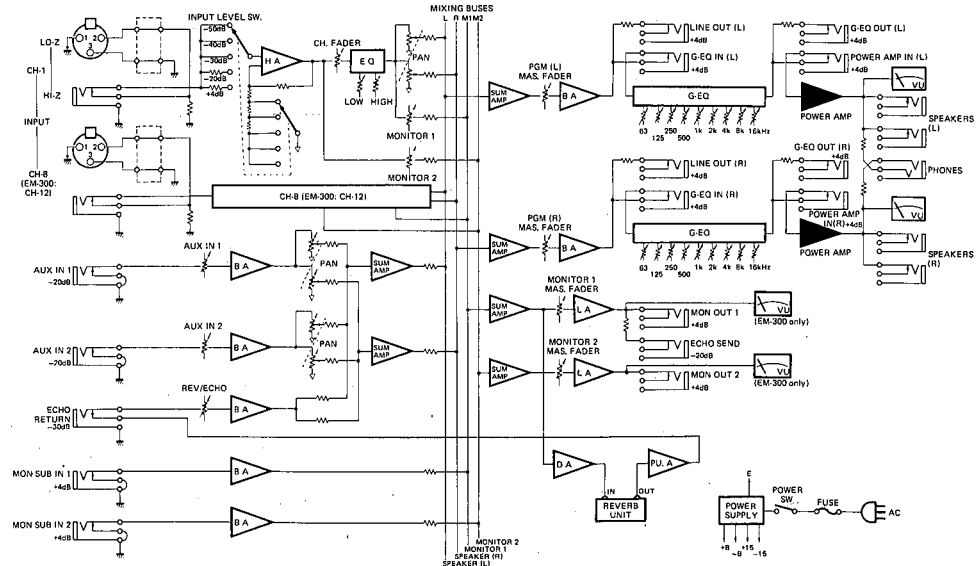

Troubleshooting

The following chart may be helpful if you encounter difficulty with your EM-Mixer.

DIFFICULTY	POSSIBLE CAUSES
NO POWER (VU Meters have no light or level)	<ol style="list-style-type: none">1. Mixer is not plugged into a "live" AC outlet.2. Fuse is blown. Replace with same size and type. If fuse blows again, see "Fuse Blown" below.
NO SIGNAL OUTPUT (VU Meters moving) (VU Meters light, but do not move)	<ol style="list-style-type: none">1. Speakers are incorrectly patched to outputs.2. Speaker cables or connectors are open/shorted.1. Input Channel Volume controls are at 0.2. Input Level switch is set improperly for channel source.3. Inputs are incorrectly connected or connected to wrong impedance jack.4. Master faders are at 0.
VERY LOW SIGNAL LEVEL (Channel and Master Volume controls turned up)	<ol style="list-style-type: none">1. Microphone or line input level is too low to drive Mixer (Needs matching transformer or preamplifier).2. Input Level switch is not set properly.3. Excessive EQ cut on Input Channel or Graphic Equalizers.
FUSE BLOWN	<ol style="list-style-type: none">1. Mixer output is patched back into a Mixer input.2. Hi-level amplified signal is fed to Mixer input.3. Short in Speaker, Monitor, Line Out, G-EQ out or other cables.4. Overheating due to covered top-panel vents.
<p>Caution: Replace fuse with one of similar size and type. If second fuse blows refer to authorized Yamaha service center.</p> <p>Never use a fuse of higher rating than that specified. Doing so will only cause damage to your Mixer.</p>	
SOUND IS DISTORTED	<ol style="list-style-type: none">1. Channel or Master Volume is too high (VU meter pinning).2. Input Level switch is too low.3. Input signal is too strong. (Use a "direct box" to lower the level).
FEEDBACK	<ol style="list-style-type: none">1. Microphones are placed in front of speakers.2. Channel EQ is set for too much boost.3. Graphic Equalizers are set for too much boost.
LOUD BUZZING	<ol style="list-style-type: none">1. Shorted cables or circuits. Turn off AC Power at once. Double check input and output connections, and replace damaged or suspect cables.2. Ground loop or input source problem. Unplug all inputs to Mixer and check each individually until buzzing starts. Buzz does not necessarily indicate a problem in the equipment, but may require the use of a common AC power line, addition or elimination of ground connections, or use of shorter cables.

Warranty & Service

WARNING: There are no user-serviceable parts in your EM-Mixer. Refer servicing to qualified Yamaha service technicians.

The Warranty Registration Card delivered with the EM-Mixer should be completed and returned to the factory at the time of purchase. Retain the Warranty ID card for your records. In the event warranty service

is required, please contact your Yamaha dealer. If you need assistance in locating a Yamaha dealer, call Yamaha Combo Product Service at (714) 522-9353

YAMAHA EM-MIXER PRODUCT WARRANTY

LIMITED ONE YEAR WARRANTY

Each Yamaha EM-Mixer is designed and manufactured to provide a high level of performance. Yamaha International Corp. believes in the craftsmanship that goes into Yamaha products. Please read this Warranty to familiarize yourself with the Warranty terms.

Yamaha desires that every new Yamaha product owner understand this Warranty; therefore, should you have any questions, ask your authorized dealer or write directly to Yamaha.

CONDITIONS OF WARRANTY

If, during the one (1) year period from the date of original purchase your product is found by Yamaha to have a defect in material or workmanship, Yamaha and/or its authorized service center will repair defects without charge for material or labor. In the event Yamaha determines that the defect cannot be repaired, then Yamaha will replace the defective product with an identical Product or one which is reasonably equivalent.

WHERE PERMITTED BY LAW, YAMAHA INTERNATIONAL CORPORATION'S LIABILITY SHALL BE LIMITED TO THAT SET FORTH IN THIS WARRANTY AND YAMAHA SHALL NOT BE LIABLE FOR INCIDENTAL OR CONSEQUENTIAL DAMAGES, INCLUDING INJURY TO PERSONS OR PROPERTY.

YAMAHA INTERNATIONAL CORPORATION MAKES NO OTHER WARRANTY OF ANY KIND EXPRESSED OR IMPLIED. ALL IMPLIED WARRANTIES OF MERCHANTABILITY AND FITNESS FOR A PARTICULAR PURPOSE WHICH EXCEED THE OBLIGATIONS AND TIME LIMITS STATED IN THIS WARRANTY ARE HEREBY DISCLAIMED BY YAMAHA INTERNATIONAL CORPORATION AND EXCLUDED FROM THIS WARRANTY.

OWNER'S RESPONSIBILITY

In order for Yamaha to provide proper warranty service, it is necessary that the purchaser of the product assume certain responsibilities.

1. Send to Yamaha the Warranty Registration Card within ten (10) days of purchase.
2. Be prepared to present the Warranty Card or proof of purchase to avoid undue difficulties in determining eligibility for warranty protection.
3. Notify your Authorized Yamaha Dealer of any defects within ten (10) days of discovery.
4. Return your Yamaha product to your Authorized Dealer in order that he may inspect and approve warranty service which shall be completed within a reasonable period of time.

WARRANTY SHALL NOT EXTEND TO:

1. Products subjected to abnormal strain, neglect, abuse, modification or accidental damage.
2. The result of normal wear.
3. Products whose trademark, name, or identification number has been changed or removed.
4. Products purchased from anyone other than an Authorized Yamaha Dealer.

This warranty is limited to the 50 states of the USA. If you plan to use the EM-Mixer outside the USA, please contact Yamaha Combo Product Service at (714) 522-9353.

YAMAHA INTERNATIONAL CORPORATION
Box 6600
Buena Park, California 90622



SINCE 1887



YAMAHA

International Corp., Box 6600, Buena Park, Calif. 90622

LOM-213 81910 5 Printed in Japan