



**MOTIF XF6**

**MOTIF XF7**

**MOTIF XF8**

---

**MUSIC PRODUCTION SYNTHESIZER**

Owner's Manual

# SPECIAL MESSAGE SECTION

**PRODUCT SAFETY MARKINGS:** Yamaha electronic products may have either labels similar to the graphics shown below or molded/stamped facsimiles of these graphics on the enclosure. The explanation of these graphics appears on this page. Please observe all cautions indicated on this page and those indicated in the safety instruction section.

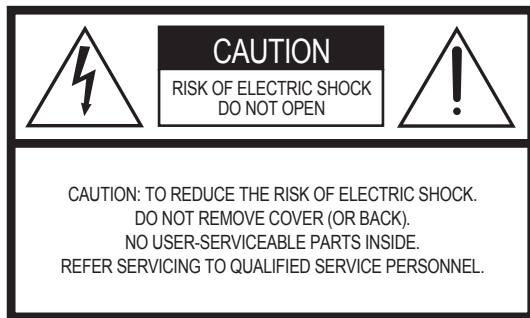

The exclamation point within the equilateral triangle is intended to alert the user to the presence of important operating and maintenance (servicing) instructions in the literature accompanying the product.

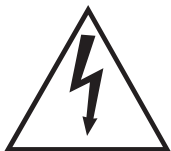

The lightning flash with arrowhead symbol, within the equilateral triangle, is intended to alert the user to the presence of uninsulated “dangerous voltage” within the product’s enclosure that may be of sufficient magnitude to constitute a risk of electrical shock.

**IMPORTANT NOTICE:** All Yamaha electronic products are tested and approved by an independent safety testing laboratory in order that you may be sure that when it is properly installed and used in its normal and customary manner, all foreseeable risks have been eliminated. **DO NOT** modify this unit or commission others to do so unless specifically authorized by Yamaha. Product performance and/or safety standards may be diminished. Claims filed under the expressed warranty may be denied if the unit is/has been modified. Implied warranties may also be affected.

**SPECIFICATIONS SUBJECT TO CHANGE:** The information contained in this manual is believed to be correct at the time of printing. However, Yamaha reserves the right to change or modify any of the specifications without notice or obligation to update existing units.

**ENVIRONMENTAL ISSUES:** Yamaha strives to produce products that are both user safe and environmentally friendly. We sincerely believe that our products and the production methods used to produce them, meet these goals. In keeping with both the letter and the spirit of the law, we want you to be aware of the following:

**Battery Notice:** This product MAY contain a small non-rechargeable battery which (if applicable) is soldered in place. The average life span of this type of battery is approximately five years. When replacement becomes necessary, contact a qualified service representative to perform the replacement.

**Warning:** Do not attempt to recharge, disassemble, or incinerate this type of battery. Keep all batteries away from children. Dispose of used batteries promptly and as regulated by applicable laws. Note: In some areas, the servicer is required by law to return the defective parts. However, you do have the option of having the servicer dispose of these parts for you.

**Disposal Notice:** Should this product become damaged beyond repair, or for some reason its useful life is considered to be at an end, please observe all local, state, and federal regulations that relate to the disposal of products that contain lead, batteries, plastics, etc.

**NOTICE:** Service charges incurred due to lack of knowledge relating to how a function or effect works (when the unit is operating as designed) are not covered by the manufacturer’s warranty, and are therefore the owners responsibility. Please study this manual carefully and consult your dealer before requesting service.

**NAME PLATE LOCATION:** The graphic below indicates the location of the name plate. The model number, serial number, power requirements, etc., are located on this plate. You should record the model number, serial number, and the date of purchase in the spaces provided below and retain this manual as a permanent record of your purchase.

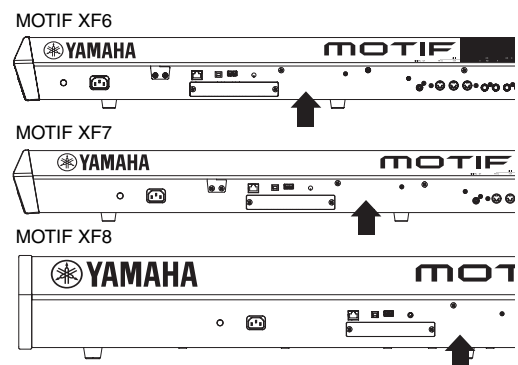

**Model** \_\_\_\_\_

**Serial No.** \_\_\_\_\_

**Purchase Date** \_\_\_\_\_

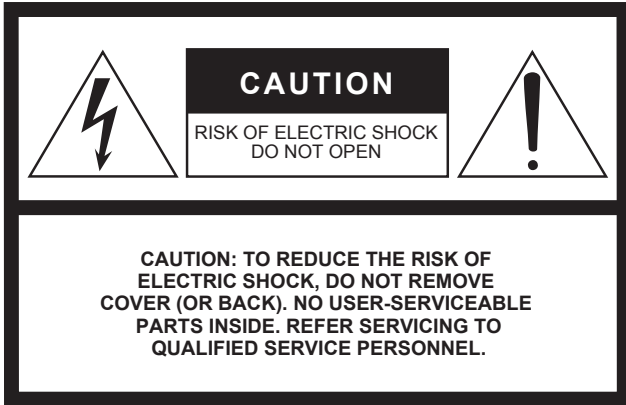

## Explanation of Graphical Symbols

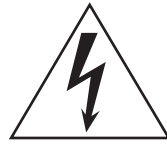

The lightning flash with arrowhead symbol within an equilateral triangle is intended to alert the user to the presence of uninsulated “dangerous voltage” within the product’s enclosure that may be of sufficient magnitude to constitute a risk of electric shock to persons.



The exclamation point within an equilateral triangle is intended to alert the user to the presence of important operating and maintenance (servicing) instructions in the literature accompanying the product.

The above warning is located on the rear of the unit.

## IMPORTANT SAFETY INSTRUCTIONS

- 1 Read these instructions.
- 2 Keep these instructions.
- 3 Heed all warnings.
- 4 Follow all instructions.
- 5 Do not use this apparatus near water.
- 6 Clean only with dry cloth.
- 7 Do not block any ventilation openings. Install in accordance with the manufacturer’s instructions.
- 8 Do not install near any heat sources such as radiators, heat registers, stoves, or other apparatus (including amplifiers) that produce heat.
- 9 Do not defeat the safety purpose of the polarized or grounding-type plug. A polarized plug has two blades with one wider than the other. A grounding type plug has two blades and a third grounding prong. The wide blade or the third prong are provided for your safety. If the provided plug does not fit into your outlet, consult an electrician for replacement of the obsolete outlet.
- 10 Protect the power cord from being walked on or pinched particularly at plugs, convenience receptacles, and the point where they exit from the apparatus.
- 11 Only use attachments/accessories specified by the manufacturer.
- 12 Use only with the cart, stand, tripod, bracket, or table specified by the manufacturer, or sold with the apparatus. When a cart is used, use caution when moving the cart/apparatus combination to avoid injury from tip-over.
- 13 Unplug this apparatus during lightning storms or when unused for long periods of time.
- 14 Refer all servicing to qualified service personnel. Servicing is required when the apparatus has been damaged in any way, such as power-supply cord or plug is damaged, liquid has been spilled or objects have fallen into the apparatus, the apparatus has been exposed to rain or moisture, does not operate normally, or has been dropped.



### WARNING

TO REDUCE THE RISK OF FIRE OR ELECTRIC SHOCK, DO NOT EXPOSE THIS APPARATUS TO RAIN OR MOISTURE.

(UL60065\_03)

### Information for Users on Collection and Disposal of Old Equipment



This symbol on the products, packaging, and/or accompanying documents means that used electrical and electronic products should not be mixed with general household waste.

For proper treatment, recovery and recycling of old products, please take them to applicable collection points, in accordance with your national legislation and the Directives 2002/96/EC.

By disposing of these products correctly, you will help to save valuable resources and prevent any potential negative effects on human health and the environment which could otherwise arise from inappropriate waste handling.

For more information about collection and recycling of old products, please contact your local municipality, your waste disposal service or the point of sale where you purchased the items.

#### For business users in the European Union

If you wish to discard electrical and electronic equipment, please contact your dealer or supplier for further information.

#### Information on Disposal in other Countries outside the European Union

This symbol is only valid in the European Union. If you wish to discard these items, please contact your local authorities or dealer and ask for the correct method of disposal.

(weee\_eu)

# PRECAUTIONS

## PLEASE READ CAREFULLY BEFORE PROCEEDING

\* Please keep this manual in a safe place for future reference.



### WARNING

Always follow the basic precautions listed below to avoid the possibility of serious injury or even death from electrical shock, short-circuiting, damages, fire or other hazards. These precautions include, but are not limited to, the following:

#### Power supply/Power cord

- Do not place the power cord near heat sources such as heaters or radiators, and do not excessively bend or otherwise damage the cord, place heavy objects on it, or place it in a position where anyone could walk on, trip over, or roll anything over it.
- Only use the voltage specified as correct for the instrument. The required voltage is printed on the name plate of the instrument.
- Use only the supplied power cord/plug.
- Check the electric plug periodically and remove any dirt or dust which may have accumulated on it.
- Be sure to connect to an appropriate outlet with a protective grounding connection. Improper grounding can result in electrical shock.

#### Do not open

- This instrument contains no user-serviceable parts. Do not attempt to disassemble or modify the internal components in any way. If it should appear to be malfunctioning, discontinue use immediately and have it inspected by qualified Yamaha service personnel.

#### Water warning

- Do not expose the instrument to rain, use it near water or in damp or wet conditions, or place containers on it containing liquids which might spill into any openings. If any liquid such as water seeps into the instrument, turn off the power immediately and unplug the power cord from the AC outlet. Then have the instrument inspected by qualified Yamaha service personnel.
- Never insert or remove an electric plug with wet hands.

#### Fire warning

- Do not put burning items, such as candles, on the unit. A burning item may fall over and cause a fire.

#### If you notice any abnormality

- When one of the following problems occur, immediately turn off the power switch and disconnect the electric plug from the outlet. Then have the device inspected by Yamaha service personnel.
  - The power cord or plug becomes frayed or damaged.
  - It emits unusual smells or smoke.
  - Some object has been dropped into the instrument.
  - There is a sudden loss of sound during use of the instrument.



### CAUTION

Always follow the basic precautions listed below to avoid the possibility of physical injury to you or others, or damage to the instrument or other property. These precautions include, but are not limited to, the following:

#### Power supply/Power cord

- Do not connect the instrument to an electrical outlet using a multiple-connector. Doing so can result in lower sound quality, or possibly cause overheating in the outlet.
- Always connect the three-pin attachment plug to a properly grounded power source. (For more information about the main power supply, see page 16.)
- When removing the electric plug from the instrument or an outlet, always hold the plug itself and not the cord. Pulling by the cord can damage it.
- Remove the electric plug from the outlet when the instrument is not to be used for extended periods of time, or during electrical storms.

#### Location

- Do not place the instrument in an unstable position where it might accidentally fall over.
- Before moving the instrument, remove all connected cables.
- When setting up the product, make sure that the AC outlet you are using is easily accessible. If some trouble or malfunction occurs, immediately turn off the power switch and disconnect the plug from the outlet. Even when the power switch is turned off, electricity is still flowing to the product at the minimum level. When you are not using the product for a long time, make sure to unplug the power cord from the wall AC outlet.

## Connections

- Before connecting the instrument to other electronic components, turn off the power for all components. Before turning the power on or off for all components, set all volume levels to minimum.
- Be sure to set the volumes of all components at their minimum levels and gradually raise the volume controls while playing the instrument to set the desired listening level.

## Handling caution

- Never insert or drop paper, metallic, or other objects into the gaps on the panel or keyboard.
- Do not rest your weight on, or place heavy objects on the instrument, and do not use excessive force on the buttons, switches or connectors.
- Do not use the instrument/device or headphones for a long period of time at a high or uncomfortable volume level, since this can cause permanent hearing loss. If you experience any hearing loss or ringing in the ears, consult a physician.

Yamaha cannot be held responsible for damage caused by improper use or modifications to the instrument, or data that is lost or destroyed.

Always turn the power off when the instrument is not in use.

## NOTICE

To avoid the possibility of damage to the product, data or other property, follow the notices below.

### ■ Handling and Maintenance

- Do not use the instrument in the vicinity of a TV, radio, stereo equipment, mobile phone, or other electric devices. Otherwise, the instrument, TV, or radio may generate noise.
- Do not expose the instrument to excessive dust or vibrations, or extreme cold or heat (such as in direct sunlight, near a heater, or in a car during the day) to prevent the possibility of panel disfiguration or damage to the internal components.
- Do not place vinyl, plastic or rubber objects on the instrument, since this might discolor the panel or keyboard.
- When cleaning the instrument, use a soft, dry/dry or slightly damp cloth. Do not use paint thinners, solvents, cleaning fluids, or chemical-impregnated wiping cloths.

### ■ Saving data

- SDRAM data is lost when you turn off the power to the instrument. Save the data to a USB storage device/external device such as a computer.
- To protect against data loss through media damage, we recommend that you save your important data onto two USB storage devices/external media.

## Information

### ■ About copyrights

- Copying of the commercially available musical data including but not limited to MIDI data and/or audio data is strictly prohibited except for your personal use.
- This product incorporates and bundles computer programs and contents in which Yamaha owns copyrights or with respect to which it has license to use others' copyrights. Such copyrighted materials include, without limitation, all computer software, style files, MIDI files, WAVE data, musical scores and sound recordings. Any unauthorized use of such programs and contents outside of personal use is not permitted under relevant laws. Any violation of copyright has legal consequences. DON'T MAKE, DISTRIBUTE OR USE ILLEGAL COPIES.

### ■ About functions/data bundled with the instrument

- This device is capable of using various types/formats of music data by optimizing them to the proper format music data for use with the device in advance. As a result, this device may not play them back precisely as their producers or composers originally intended.

### ■ About this manual

- The illustrations and LCD screens as shown in this manual are for instructional purposes only, and may appear somewhat different from those on your instrument.
- Windows is a registered trademark of Microsoft® Corporation in the United States and other countries.
- Apple, Mac and Macintosh are trademarks of Apple Inc., registered in the U.S. and other countries.
- FireWire and the FireWire symbol are trademarks of Apple, Inc., registered in the U.S. and other countries. The FireWire logo is a trademark of Apple, Inc.
- The company names and product names in this manual are the trademarks or registered trademarks of their respective companies.

### About the latest Firmware Version

Yamaha may from time to time update firmware of the product and the accessory application software without notice for improvement. We recommend that you check our web site for later releases and upgrade your firmware of the MOTIF XF or the accessory application software.

<http://www.yamahasyth.com/>

Note that the explanations in this Owner's Manual apply to the version of firmware when this Owner's Manual was produced. For details about the additional functions due to later releases, refer to the above website.

# Welcome

## A message from the MOTIF XF Development Team

Thank you for purchasing the Yamaha MOTIF XF Music Synthesizer.

Since the first MOTIF was launched in 2001, the MOTIF series has evolved with the times and has finally reached fourth-generation status.

The new MOTIF XF adds a number of significant enhancements to its predecessors and features many powerful functions that make it an indispensable tool in both music production and live performance.

Second, the User Interface via the color LCD display introduced from the MOTIF XS has been drastically improved so that it is easy to view the important information like Voice program number even another keyboard is located above the MOTIF XF at the live scene.

In terms of the sound, the MOTIF XF provides a wide variety of Voices that fully take advantage of the Expanded Articulation feature, which enables expressive tonal change (via Velocity and the Assignable Function buttons). Many Voices have been added and enhanced to improve the MOTIF's famed set of ultra-realistic acoustic instrument sounds. We've also strengthened the synthesizer sound engine, giving it a wealth of powerful and dynamic synth waveforms and effect-related Voices. They allowing you to truly play and perform with the synth sounds, tweaking the filters and controllers for extraordinary expressiveness—far beyond even what you've come to expect from a digital keyboard.

Secondly, the user interface and the color LCD display introduced with the MOTIF XS has been improved dramatically, making it even easier to view important information, such as the Voice program name and number—even when another keyboard is placed above the MOTIF XF onstage.

Furthermore, in one of the most important advantages of the MOTIF XF, an optional Flash Memory Expansion Board can be installed. This feature was included in response to many and repeated requests from power users. Now, Sample (audio) data remains on the board, even when the power is turned off—allowing you to instantly use Waveforms containing Samples you've recorded when you turn the power back on, without the need to load them from an external USB storage device.

We are confident these new features, in addition to the already strong set of functions of the MOTIF series, will aid in all your musical endeavors—from writing and recording to live performance.

In order to take full advantage of the MOTIF XF's functionality, please read this manual carefully. We also recommend that you keep this manual in a safe and handy place for future reference.

We really hope that the MOTIF XF will help your creativity and musical work grow by leaps and bounds.

Enjoy!

Sincerely,

The Yamaha MOTIF XF Development Team

## About this Manual



### Owner's Manual (this book)

Provides overall explanations of the basic functions for each mode.

Please use this Owner's Manual for an overview of the basic and more important operations of the MOTIF XF. If you need more detailed information or instructions on specific functions, use the Reference Manual described below.



### PDF documentation (included in the CD-ROM)

The following manuals are available in the included CD-ROM as PDF format. Please insert the CD-ROM to the disk drive of your computer then click/open any of them.

#### ■ Reference Manual

Explains in detail about the internal structure, connection examples and all the parameters for each mode. Use this manual if you need more detailed information which is not covered in the Owner's Manual.

If you need more information on the current status or display of the MOTIF XF, use the Function Tree provided in this manual. This convenient Function Tree helps you quickly find the page covering the relevant function or operation.

#### ■ Data List

This contains various important lists such as the Voice List, Waveform List, Performance List, Performance List, Effect Type List, Master Program List, Arpeggio Type List, MIDI Implementation Chart and Remote Control Function List.

## How to use the PDF manuals

The Reference Manual and the Data List are provided as data documents in PDF format. These PDF files can be viewed and read on a computer. When using Adobe® Reader® to view a PDF file, you can search for specific words, print a specific page or link to open a desired section in the manual. The term search and link functions are especially convenient methods of navigating through a PDF file, and we recommend that you use them.

The latest version of Adobe Reader can be downloaded from the following URL.  
<http://www.adobe.com/products/reader/>

## Accessories

- AC Power cord
- Owner's Manual (this book)
- CD-ROM x 1 (Containing the PDF files of the Reference Manual and Data List)
- DVD-ROM x 1 (containing DAW software)

## About the accessory disk

### Special Notice

- The software included in the accessory disk and the copyrights thereof are under exclusive ownership by Steinberg Media Technologies GmbH.
- Copying of the software or reproduction of this manual in whole or in part by any means is expressly forbidden without the written consent of the manufacturer.
- Yamaha makes no representations or warranties with regard to the use of the software and documentation and cannot be held responsible for the results of the use of this manual and the software.
- This disk is NOT for audio/visual purposes. Do not attempt to play the disk on an audio/visual CD/DVD player. Doing so may result in irreparable damage to your player.
- Note that Yamaha does not offer technical support for the DAW software in the accessory disk.

### About the DAW software in the accessory disk

The accessory disk contains DAW software both for Windows and Mac.

#### NOTE

- Make sure to install DAW software under the "Administrator" account.
- In order to have continuous use of DAW software, including support and other benefits, you will need to register the software and activate your software license by starting it while the computer is connected to the Internet. Click the "Register Now" button shown when the software is started, then fill in all required fields for registration. If you do not register the product, you will be unable to use the application after a limited period of time expires.
- If you are using a Mac computer, double-click the "\*\*\*\*.mpkg" file to start installation.

For information about the minimum system requirements and latest information on the software in the disk, check the web site below.

<http://www.yamahasynth.com/download/>

### About software support

Support for the DAW software in the accessory disk is provided by Steinberg on its website at the following address.

<http://www.steinberg.net>

You can visit the Steinberg site also via the Help menu of the included DAW software. (The Help menu also includes the PDF manual and other information on the software.)

# Main Features

## ■ New, enhanced Voice set covering a wide range of music styles

The MOTIF XF is loaded with 741 MB of preset Wave memory—more than double the size of the previous MOTIF XS—and has 136 additional Voices. These new Voices include Synthesizer, Brass, Saxophone, Strings, Guitar, Bass and Drum Kit as well as Piano, Clavi, and Combo Organ.

## ■ XA (Expanded Articulation) feature

Expanded Articulation (XA) is a newly designed, sophisticated tone generation system that allows you to more effectively recreate realistic sound and natural performance techniques—such as legato and staccato—often used on acoustic instruments but up to now unavailable or difficult to realize on electronic keyboards. This feature enables:

- Realistic legato performance
- Authentic note release sound
- Special “key off” sounds, by setting the XA control parameter for desired Elements
- Switching among different sounds to recreate the natural performance on an acoustic instrument
- Potential for completely new sounds and new styles of playing

## ■ Extensive Effect Processing

The MOTIF XF gives you a wide array of signal processing options, including separate Reverb and Chorus, an overall Master Effect, including multi-band compression, five-band master EQ, and a total of eight independent Insertion Effects. The latter include a huge variety of effects, plus a special Vocoder feature.

## ■ Improved User Interface

Unlike the MOTIF series, this new MOTIF XF provides several design types of the LCD display for each mode. From these types, you can select the desired one according to the use scene including the music creation and live performance.

## ■ Expanded, enhanced Arpeggio function, including Ending types

The MOTIF XF has added 1,248 new Arpeggio types, for a total of 7,881 Arpeggio types—including Ending types, as well as synthesizer and vintage sequencer style Arpeggios and Drum/Percussion loop Arpeggios.

## ■ Built-in SDRAM for Sampling

Unlike its predecessors, the MOTIF XF features 128 MB of SDRAM built in, letting you perform audio sampling, without the need for installing an optional DIMM.

## ■ Optional Flash Memory Expansion Module

The MOTIF XF also newly provides the option of installing a Flash Memory Expansion Module (FL512M/FL1024M), allowing you to internally store Waveforms that include your sampled audio sounds, and keep those Waveforms/sounds intact, even when turning off the power.

## ■ Responsive, expressive keyboard

The MOTIF XF6 features a 61-key keyboard, while the MOTIF XF7 has 76 keys with the high-quality FSX keyboard and the MOTIF XF8 has 88 keys with the high-quality BH (Balanced Hammer) keyboard. All are equipped with a touch response feature (both initial touch and aftertouch). These allow you to expressively change the sound in various ways — initial touch by the strength with which you play the keys, and aftertouch by how strongly you press the keys when holding them down.

## ■ Audio Record/Playback

You can now record your performances on the MOTIF XF as WAV-format audio files (44.1-kHz, 16-bit, stereo) on a USB storage device or a computer connected via a network. What's more, the MOTIF XF can now also play WAV or AIFF audio files stored on a connected USB storage device or computer.

## ■ Integration with Cubase

The MOTIF XF is specially designed to work seamlessly with Cubase, Steinberg's full-featured DAW software (included in the accessory disk) — giving you a comprehensive, all-in-one music production system, in which hardware and software are fully integrated.



# Contents

Welcome		
—A message from the MOTIF XF Development Team	6	
About this Manual	6	
Accessories	7	
About the accessory disk	7	
Main Features	8	
<b>Controls and Functions</b>	<b>10</b>	
Top Panel	10	
Rear Panel	14	
<b>Setting Up</b>	<b>16</b>	
Power Supply	16	
Connecting Speakers or Headphones	16	
Powering Up the System	16	
Adjusting the Volume and the Brightness of the Display	17	
Listening to the Demo Song	17	
Resetting the User Memory to the Initial Factory Settings	18	
<b>Basic Operation</b>	<b>19</b>	
<b>Modes</b>	<b>21</b>	
<b>Playing the Keyboard in the Voice mode</b>	<b>22</b>	
Selecting a Preset Voice	22	
Using the Category Search function	23	
Using the Arpeggio function	23	
Changing the Arpeggio type	24	
Using the Controllers	25	
Using the Knobs	25	
Voice Editing	26	
Enhancing the sound with Effects	27	
Storing the edited Voice	27	
<b>Playing the Keyboard in the Performance mode</b>	<b>28</b>	
Selecting a Performance	28	
Performance Play mode indications	28	
Using the Controllers and Knobs	28	
How Voices are assigned to Parts of a Performance	28	
Creating a Performance by combining Voices	29	
Changing the Arpeggio settings for each Part	30	
Storing the Performance	30	
<b>Recording in the Performance mode</b>	<b>31</b>	
Performance Record Structure	31	
Recording the Melody and Arpeggio playback to the Song	31	
Recording Arpeggio playback to a Pattern	32	
<b>Audio Record/Playback</b>	<b>33</b>	
Recording your performance as audio	33	
Playing an audio file	34	
<b>Using as a Master Keyboard (Master Mode)</b>	<b>35</b>	
Registering the Edited Voice/Performance/Song/Pattern	35	
Making settings for use as a master keyboard	35	
<b>Creating an original Song</b>	<b>37</b>	
Terminology	37	
Song Playback	37	
Recording to a track	38	
Creating a Song by using Arpeggio	38	
Correcting wrong notes	39	
Creating a swing feel—Play Effect	40	
Storing the created Song	40	
<b>Creating an original Pattern</b>	<b>41</b>	
Pattern Structure	41	
Listening to the Demo Patterns	41	
Viewing the Demo Pattern's Patch display	42	
Creating a Pattern by using Arpeggio	42	
Storing the created Pattern	43	
Creating a Pattern Chain for converting to a Song	43	
<b>Multi-timbral Tone Generator Settings for Song/Pattern Playback (Mixing mode)</b>	<b>46</b>	
<b>Using the Sampling feature</b>	<b>47</b>	
Setting up for Sampling	47	
Sampling in the Voice/Performance mode	48	
Sampling in the Pattern mode	50	
Sampling a one-shot sound in the Song mode	52	
Saving a Waveform to the Flash Memory Expansion Module	53	
<b>Making Global System Settings (Utility mode)</b>	<b>54</b>	
Setting automatic power-on tasks	54	
Selecting the Design Type of the display	54	
Adjusting the tuning	55	
Transpose	55	
<b>Using a Connected Computer</b>	<b>56</b>	
Using the USB TO HOST terminal	56	
Using the MIDI terminal	57	
Using the IEEE1394 terminal	57	
Song playback from a DAW using the MOTIF XF as a tone generator	59	
Recording your performance on the MOTIF XF to the DAW	59	
Using another tone generator together with the MOTIF XF	60	
Using the MOTIF XF as an audio interface	61	
Remote-controlling the software (Remote mode)	61	
Using the MOTIF XF Editor VST	63	
<b>Saving / Loading Data in the File mode</b>	<b>64</b>	
Saving the settings to a USB storage device	64	
Loading the settings from a USB storage device	64	
USB storage devices	65	
<b>Display Messages</b>	<b>66</b>	
<b>Troubleshooting</b>	<b>68</b>	
<b>Installing Optional Hardware</b>	<b>74</b>	
<b>Specifications</b>	<b>78</b>	
<b>Index</b>	<b>80</b>	

# Controls and Functions

## Top Panel

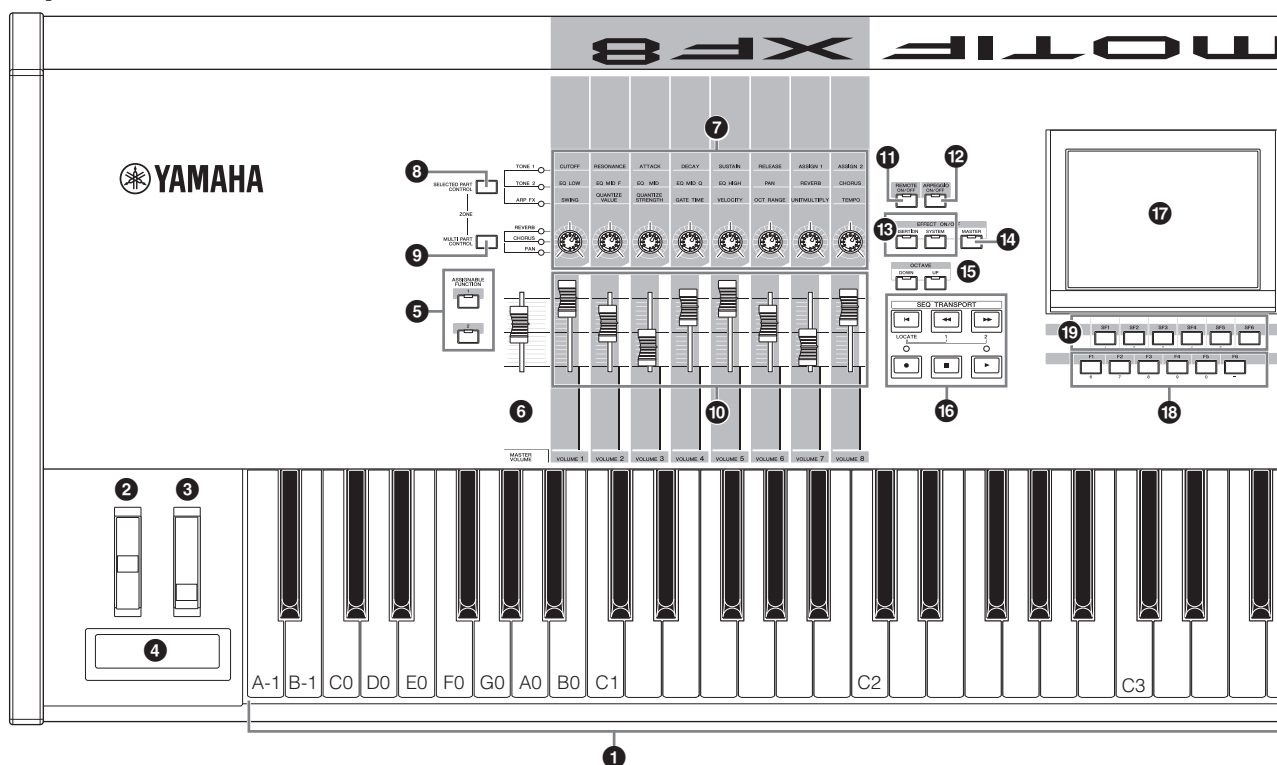

### 1 Keyboard

The MOTIF XF6 features a 61-key keyboard, while the MOTIF XF7 has 76 keys and the MOTIF XF8 has 88 keys. All are equipped with a touch response feature (both initial touch and aftertouch). With initial touch, the instrument senses how strongly or softly you play the keys, and uses that playing strength to affect the sound in various ways, depending on the selected Voice. With aftertouch, the instrument senses how much pressure you apply to the keys while playing, and uses that pressure to affect the sound in various ways, depending on the selected Voice. Moreover, any of a variety of functions can be assigned to aftertouch for each Voice.

### 2 Pitch Bend wheel

Controls the pitch bend effect. You can also assign other functions to this controller.

### 3 Modulation wheel

Controls the modulation effect. You can also assign other functions to this controller.

### 4 Ribbon Controller

This controller is touch sensitive, and is controlled by running your finger lightly across its surface laterally. You can also assign other functions to this controller.

### 5 ASSIGNABLE FUNCTION buttons

According to the XA Mode (Expanded Articulation Mode) settings in the Voice Element Edit mode, you can call up the specific Element of the selected Voice by pressing each of these buttons during your keyboard performance. In addition, you can assign other functions to these buttons.

### 6 MASTER VOLUME (page 17)

Move the slider upwards to raise the output level from the OUTPUT L/R jacks and the PHONES jack.

**NOTE** The MASTER VOLUME cannot control the volume of audio signal output from the DIGITAL OUT connector and IEEE1394 connector of the optional FireWire expansion board (if installed).

### 7 Knobs (page 25)

These eight highly versatile knobs let you adjust various aspects or parameters of the current Voice. Use the [SELECTED PART CONTROL] button or [MULTI PART CONTROL] button to change the functions assigned to the knobs.

### 8 [SELECTED PART CONTROL] button (page 25)

Pressing this button changes the functions assigned to the eight knobs. The lamp next to the currently active parameters will light. In the Voice mode, the function of each knob is applied to the current Voice. In the Performance mode, the function of each knob is applied only to the currently selected Part or to all Parts depending on the setting. In the Song/Pattern mode, the function of each knob is applied only to the currently selected Part.

**NOTE** For more information about ❶ – ❸, refer to “Controller Block” in the Reference Manual.

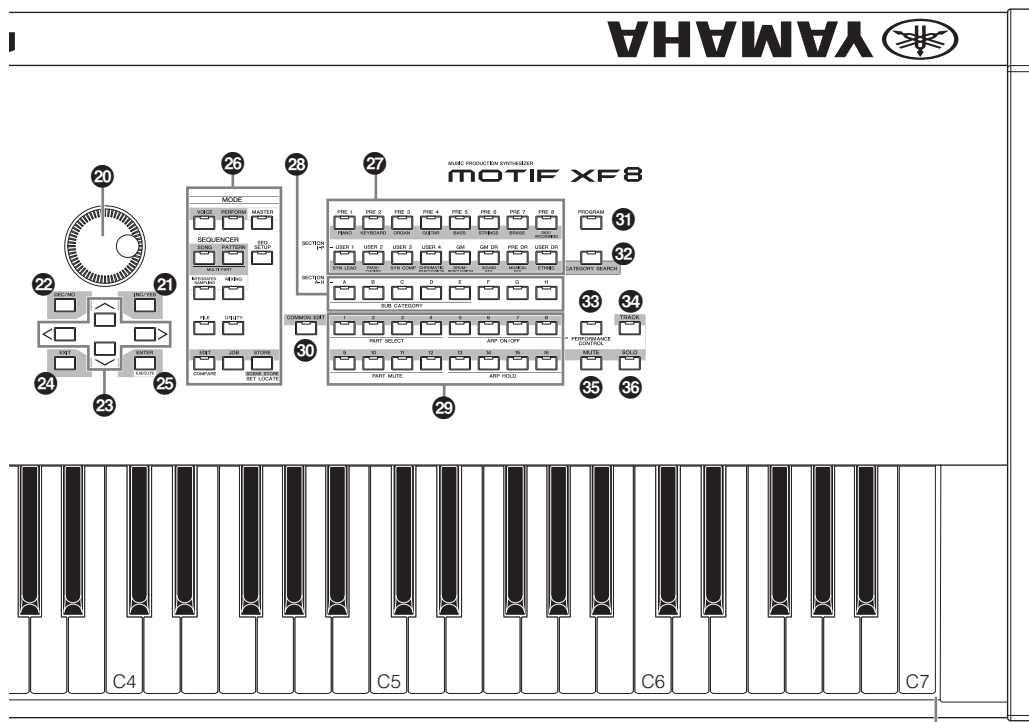

**❹ [MULTI PART CONTROL] button**

Pressing this button changes the functions assigned to the eight knobs in the Performance /Song/Pattern mode. The lamp next to the currently active parameters will light. In the Performance mode, the four knobs at the left end correspond to Parts 1 – 4. In the Song/Pattern mode, all knobs correspond to Parts 1 – 8 or 9 –16 (depending on the currently selected Part)

**❺ Control Sliders (pages 25, 28)**

These sliders control the volume of the sound in different ways depending on the mode selected:  
 Voice mode: volume of the eight Elements  
 Performance mode: volume of the four Parts  
 Song/Pattern modes: volume of the eight Parts, including the current Part  
 Master mode: volume or specified Control Change number of the eight Zones

**NOTE** If all of the Control Sliders are set to the minimum, you may not hear any sound from the instrument, even when playing the keyboard or a Song/Pattern. If this is the case, raise all the sliders to a suitable level.

**NOTE** The MASTER VOLUME slider adjusts the audio output level from this instrument. On the other hand, the Control Sliders adjust the volume for each Element of the Voice or each Part of the Performance/Song/Pattern as a parameter. Accordingly, the values set via the Control Sliders can be stored as Voice, Performance, Song, or Pattern data.

**❻ [REMOTE ON/OFF] button (page 61)**

The Remote mode lets you control sequencer software on your computer from the panel controls of the instrument. Turn the [ON/OFF] button on to enter the Remote mode.

**❼ [ARPEGGIO ON/OFF] button (page 23)**

Press this button to enable or disable playback of the Arpeggio for each Voice, Performance, Song, or Pattern. If the Arpeggio Switch of the selected Part is set to off in the Performance/Song/Pattern mode, however, pressing this button has no effect.

**❽ EFFECT buttons**

The extensive effect block of the instrument provides Insertion effects (eight sets, with two effect units per set), System Effects (Reverb and Chorus), and Master Effects. The effects can be applied to the keyboard-played Voices and to Song/Pattern playback. When the lamp of the [INSERTION] or [SYSTEM] button is turned on, the corresponding Effect is on.

**14 [MASTER EFFECT] button**

When this button is pressed (the lamp lights), the Master Effect is applied to the overall sound of this instrument. Also, to access the Master Effect setting display, press and hold the [MASTER EFFECT] button for a second or two.

**15 OCTAVE [UP] and [DOWN] buttons**

Use these buttons to change the note range of the keyboard. To restore the normal octave setting, press both buttons simultaneously.

**16 SEQ TRANSPORT buttons (page 17)**

These buttons control recording and playback of the Song/Pattern sequence data.

**[◀] (Top) button**

Instantly returns to the beginning of the current Song or Pattern (i.e., the first beat of the first measure).

**[◀◀] (Reverse) button**

Press briefly to move back one measure at a time, or hold to continuously rewind.

**[▶▶] (Forward) button**

Press briefly to move forward one measure at a time, or hold to continuously fast-forward.

**[●] (Record) button**

Press this to enable recording (Song or Pattern phrase). (The indicator lights.)

**[■] (Stop) button**

Press to stop recording or playback.

**[▶] (Play) button**

Press to start playback from the current point in the Song or Pattern. During recording and playback, the indicator flashes at the current tempo.

**17 LCD Display (page 17)**

The large backlit LCD displays the parameters and values related to the currently selected operation or mode.

**18 [F1] – [F6] (Function) buttons (page 19)**

These buttons located directly below the LCD display call up the corresponding functions indicated in the display.

**19 [SF1] – [SF6] (Sub Function) buttons (page 19)**

These buttons located directly below the LCD display call up the corresponding sub functions indicated in the display. These buttons can be also used to call up the Arpeggio type in some displays of the Play mode, Edit mode and Record mode. These buttons can be also used as Scene buttons in the Song Play/Song Record/Pattern Play/Pattern Record modes.

**20 Data dial (page 19)**

For editing the currently selected parameter. To increase the value, turn the dial right (clockwise); to decrease the value, turn the dial left (counter-clockwise). If a parameter with a wide value range is selected, you can change the value in broader strokes by quickly turning the dial.

**21 [INC/YES] button (page 19)**

For increasing the value of the currently selected parameter. Also, this is used to actually execute a Job or a Store operation.

**22 [DEC/NO] button (page 19)**

For decreasing the value of the currently selected parameter. Also, this is used to cancel a Job or a Store operation.

**NOTE** You can also use the [INC/YES] and [DEC/NO] buttons to quickly move through parameter values in 10-unit jumps, especially those with large ranges. Simply hold down one of the buttons (of the direction you want to jump), and simultaneously press the other button. For example, to jump in the positive direction, hold down the [INC/YES] button and press [DEC/NO].

**23 Cursor buttons (page 19)**

The cursor buttons move the “cursor” around the LCD display screen, highlighting and selecting the various parameters.

**24 [EXIT] button**

The menus and displays of the MOTIF XF are organized according to a hierarchical structure. Press this button to exit from the current display and return to the previous level in the hierarchy.

**25 [ENTER] button**

Use this button to actually enter a number when selecting a Memory or Bank for Voice or Performance. Also use this button to execute a Job or a Store operation.

**26 MODE buttons (page 21)**

These buttons select the MOTIF XF operating modes (e.g., Voice mode).

**27 Bank buttons (page 22)**

Each button selects a Voice or Performance Bank. When the [CATEGORY SEARCH] button is turned on, these buttons can be used to select the Main category (printed below each button). When the [TRACK] button is turned on in the Pattern mode, these lower buttons are used to select the desired Section from I – P.

**28 Group [A] – [H] buttons (page 22)**

Each button selects a Voice or Performance Group. When the [CATEGORY SEARCH] button is turned on, these buttons can be used to select the Sub category. When the [TRACK] button is turned on in the Pattern mode, these buttons are used to select the desired Section from A – H.

**29 Number [1] – [16] buttons (page 22)**

Use of these buttons differs depending on the on/off status of the [TRACK], [MUTE], [SOLO] and [PERFORMANCE CONTROL] buttons.

## Functions of the Number [1] – [16] buttons

Mode	[PERFORMANCE CONTROL] button	[TRACK] button	[MUTE] button	[SOLO] button
Voice Play	—	Keyboard transmit channel setting	—	—
Normal Voice Edit	—	Changes the Edit mode from Common Edit to Element Edit and Element selection (1 – 8)	Element Mute setting (9 – 16)	Solo Element selection (9 – 16)
Drum Voice Edit	—	Changes the Edit mode from Common Edit to Drum Key Edit	—	—
Performance Play	Performance Control (30)	Keyboard transmit channel setting	Part Mute setting (1 – 4)	Solo Part selection (1 – 4)
Performance Edit	Performance Control (30)	Performance Part selection (1 – 4)	Part Mute setting (1 – 4)	Solo Part selection (1 – 4)
Master Play	—	Keyboard transmit channel setting (when memorizing the Voice mode or Performance mode to the current Master) or Song/Pattern track selection (when memorizing the Song mode or Pattern mode to the current Master)	—	—
Master Edit	—	Changes the Edit mode from Common Edit to Zone Edit and Zone selection (1 – 8)	—	—
Song Play/ Pattern Play	—	Song/Pattern track selection	Song/Pattern track Mute setting	Solo track selection
Song Mixing/ Pattern Mixing	—	Song/Pattern Part selection	Song/Pattern Part Mute setting	Solo Part selection
Mixing Voice Edit	Element selection (1 – 8)	Element selection (1 – 8)	Element Mute setting (9 – 16)	Solo Element selection (9 – 16)

### 30 [COMMON EDIT] button

Turning this button on enters the Common Edit mode, which lets you edit the parameters commonly applied to all Elements, Parts or Zones in the Voice Edit mode, Performance Edit mode, Song Mixing Edit mode, Pattern Mixing Edit mode, and Mixing Voice Edit mode.

### 31 [PROGRAM] button (page 22)

When this button is turned on, using the Bank/Group/Number buttons selects a Voice, Performance, Song, Pattern, and Master in the corresponding mode.

### 32 [CATEGORY SEARCH] button (page 23)

This button is used to call up the Category Search function (page 23).

In the Voice Play mode, this function can be used for finding and selecting a desired Voice.

In the Performance Play mode, this function can be used for assigning a desired Voice to each Part on the [F2] Voice display. On the displays other than [F2], this function can be used for selecting a desired Performance.

On the [F1] Track View display in the Song Play mode, [F1] Play display in the Pattern Play mode, and [F1] 1 – 16 display in the Mixing Play mode, this function can be used for assigning a desired Voice to each Part.

### 33 [PERFORMANCE CONTROL] button

This button is available only in the Performance Mode. When this button is turned on, the following functions are assigned to the Number buttons [1] – [16].

Number buttons	Function
[1] – [4]	Selecting Parts 1 – 4.
[5] – [8]	Setting the Arpeggio Switch to on/off for Parts 1 – 4.
[9] – [12]	Setting the mute status for Parts 1 – 4.
[13] – [16]	Setting the Arpeggio Hold for Parts 1 – 4.

### 34 [TRACK] button (page 38)

Turning this button on in the Song/Pattern mode enables the Number [1] – [16] buttons for selecting corresponding Song/Pattern tracks. When this button is turned on in the Pattern mode, the Group buttons [A] – [H] can be used to select the desired Section from A – H and the lower buttons of the Bank buttons can be used to select the desired Section from I – P.

### 35 [MUTE] button (page 37)

Turning this button on in the Normal Voice Edit mode and Mixing Voice Edit mode enables the Number buttons [1] – [8] for muting Voice Elements (1 – 8). Turning this button on in the other modes enables the Number buttons [1] – [16] for muting Performance Parts (1 – 4), Song Tracks/Parts (1 – 16), and Pattern Tracks/Parts (1 – 16).

### 36 [SOLO] button (page 37)

Turning this button on in the Normal Voice Edit mode and Mixing Voice Edit mode enables the Number buttons [1] – [8] for soloing a Voice Element (1 – 8). Turning this button on in the other modes enables the Number buttons [1] – [16] for soloing a Performance Part (1 – 4), a Song Track/Part (1 – 16), and a Pattern Track/Part (1 – 16).

**NOTE** The on/off status of the buttons (34 – 36) affects the Number [1] – [16] buttons in different ways, depending on the currently selected mode. Refer to the table at the top of this page.

## Rear Panel

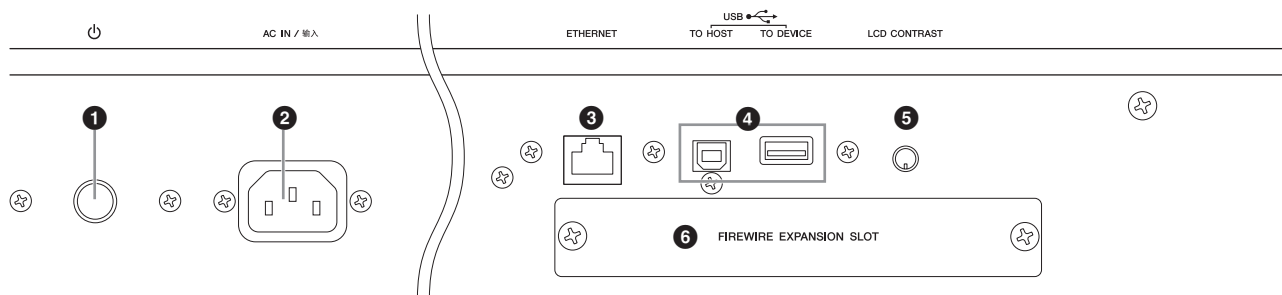

### 1 (Power switch) (page 16)

Press to turn power on () or off ()

### 2 AC IN (AC Power Cord Socket)

Be sure to plug the AC power cord into this socket before plugging the power cord into an AC outlet. Use only the AC power cord supplied with this instrument. If the supplied cord is lost or damaged and needs to be replaced, contact your Yamaha dealer. The use of an inappropriate replacement can pose a fire and shock hazard!

### 3 ETHERNET connector

You can connect the MOTIF XF to a LAN network by using this connector and a LAN cable. When connected to a network, the MOTIF XF is capable of mounting and accessing drives of computers on the same network. For more information, refer to “Connections” in the Reference Manual.

### 4 USB connectors (pages 56, 65)

There are two different types of USB connectors, and the rear panel of the instrument features both.

The USB TO HOST connector is used to connect this instrument to the computer via the USB cable and allows you to transfer MIDI data between the devices. Unlike MIDI, USB can handle multiple ports (page 57) via a single cable. The USB connection between the instrument and the computer can only be used for transfer of MIDI data. No audio data can be transferred via USB.

The USB TO DEVICE connector is used to connect this instrument to a USB storage device (hard disk drive, CD-ROM drive, flash memory, etc.) via the USB cable. This lets you save data created on this instrument to an external USB storage device and load data from a USB device to the instrument. Save/Load operations can be performed in the File mode.

#### USB

USB is an abbreviation for Universal Serial Bus. It is a serial interface for connecting a computer with peripheral devices, and enables much faster data transfer compared to conventional serial port connections.



### 5 LCD Contrast Control (page 17)

Use this control to set the LCD display for optimum legibility.

### 6 FireWire expansion board (FW16E) cover (page 74)

The optional FW16E can be installed by removing this cover. By installing an FW16E board (equipped with the IEEE1394 connector), you can upgrade your MOTIF XF for convenient and easy connection to an IEEE1394-compatible computer.

**NOTE** Yamaha recommends that you use an IEEE1394 cable with a length of 4.5 meters or less.

**NOTE** The digital audio output via the IEEE1394 connector is fixed to a resolution of 24 bit/44.1 kHz.

### 7 DIGITAL OUT connector

Use this connector to output digital signals over a coaxial (RCA-pin) cable. The digital signal format is CD/DAT (S/P DIF). This connector outputs a digital signal of 44.1 kHz/24 bit. By using this jack, you can record the keyboard performance or Song/Pattern playback of this synthesizer to external media (e.g., a CD recorder) with exceptionally high-quality sound—thanks to the direct digital connection.

**NOTE** Audio signal output from the DIGITAL OUT connector is equivalent to the one output from the OUTPUT L/MONO and R jacks with the exception that audio signal is digital or analog. It results that the output setting of the DIGITAL OUTPUT for each Part or each Drum Key depends on the one of the OUTPUT L/ MONO and R jacks.

### 8 MIDI IN/OUT/THRU connectors

MIDI IN is for receiving control or performance data from another MIDI device, such as an external sequencer. MIDI THRU is simply for redirecting any received MIDI data (via MIDI IN) to connected devices, allowing convenient chaining of additional MIDI instruments. MIDI OUT is for transmitting all control, performance and playback data from the MOTIF XF to another MIDI device, such as an external sequencer.

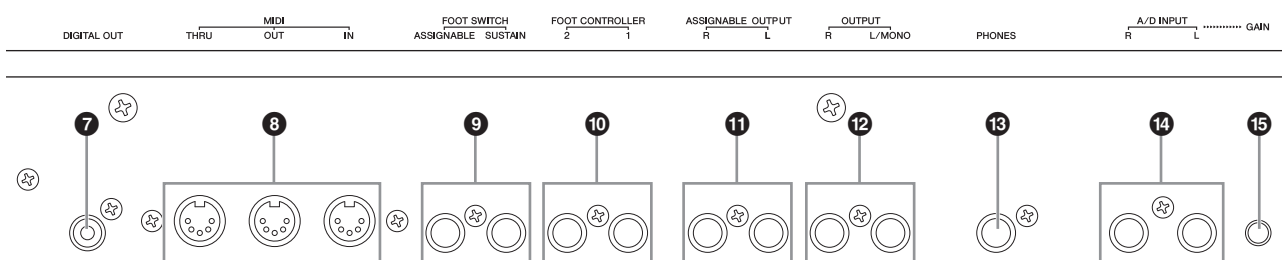

### 9 FOOT SWITCH jacks

For connection of an optional FC3/FC4/FC5 Footswitch to the SUSTAIN jack and a FC4/FC5 Footswitch to the ASSIGNABLE jack. When connected to the SUSTAIN jack, the Footswitch controls sustain. When connected to ASSIGNABLE, it can control one of various different assignable functions. The function assignment can be set in the Voice Edit mode.

For more information, refer to “Voice mode” in the Reference Manual.

### 10 FOOT CONTROLLER jacks

For connection of optional foot controllers (FC7 and FC9). Each jack lets you continuously control one of various different assignable functions—such as volume, tone, pitch, or other aspects of the sound. The function assignment can be set in the Voice Edit mode.

For more information, refer to “Voice mode” in the Reference Manual.

### 11 ASSIGNABLE OUT L and R jacks

Line level audio signals are output from this instrument via these phone jacks (1/4" mono phone plug). These outputs are independent of the main output (at the L/MONO and R jacks below), and can be freely assigned to any of the Drum Voice keys or the Parts. This lets you route specific Voices or sounds for processing with a favorite outboard effect unit. The Parts which can be assigned to these jacks are as follows:

- Audio Part in the Voice mode
- Drum Voice key to which the drum/percussion instrument is assigned
- Any Part of a Performance\*
- Any Part of a Song\*
- Any Part of a Pattern\*

\*Including the Audio Input Part

The Part assignment above can be set via the Output Select parameter. For details, refer to the Reference Manual.

### 12 OUTPUT L/MONO and R jacks

Line level audio signals are output via these phone jacks. For monophonic output, use only the L/MONO jack.

### 13 PHONES (Headphone) jack (page 16)

This standard stereo phones jack is for connection to a set of stereo headphones.

### 14 A/D INPUT jacks (page 47)

External audio signals can be input via these phone jacks (1/4" mono phone plug). Various devices such as microphone, guitar, bass, CD player, synthesizer can be connected to these jacks and their audio input signal can be sounded as the Audio Part of the Voice, Performance, Song, or Pattern. In the Sampling mode (page 47), these jacks are used for capturing audio data as samples. In addition, you can use the special Vocoder feature by connecting a microphone to this L jack and inputting your Voice to the microphone.

Use 1/4" mono phone plugs. For stereo signals (such as from audio equipment), use both jacks. For mono signals (such as from a microphone or guitar), use only the L jack.

### 15 GAIN knob (page 50)

For adjusting the input gain of the audio at the A/D INPUT jacks (above). Depending on the connected device (microphone, CD player, etc.), you may need to adjust this for optimum level.

# Setting Up

## Power Supply

Connect the supplied AC power cord in the following order. Make sure the Power switch on the MOTIF XF is set to off.

- 1 Connect the supplied power cord to the AC IN on the instrument's rear panel.
- 2 Connect the other end of the power cord to an AC outlet.

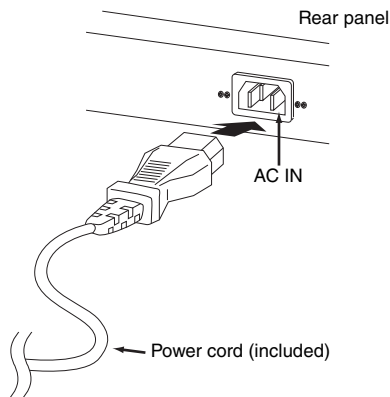

**NOTE** Follow this procedure in reverse order when disconnecting the power cord.



### WARNING

Use only the AC power cord supplied with the MOTIF XF. The use of an inappropriate replacement can pose a fire and shock hazard!



### CAUTION

- Make sure your MOTIF XF meets the voltage requirement for the country or region in which it is being used. The power cord includes a grounding pin to prevent electrical shock and damage to equipment. When connecting to an outlet, connect the adaptor's ground lead to the ground screw. If you're unsure how to connect, then contact your Yamaha dealer or service center.
- Even when the Power switch is in the off position, a small amount of electricity is still flowing to the unit. When you are not using the MOTIF XF for a long time, make sure to unplug the AC power adaptor from the wall AC outlet.

## Connecting Speakers or Headphones

Since the MOTIF XF has no built-in speakers, you will need to monitor the sound of the instrument by using external equipment. Connect a set of headphones, powered speakers, or other playback equipment as illustrated below. When making connections, be sure that your cables have the appropriate ratings.

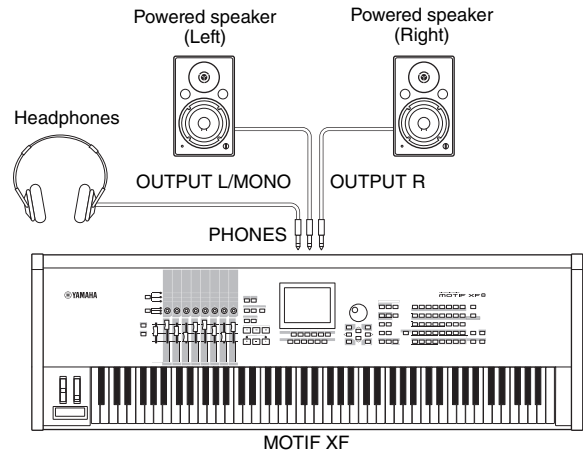

## Powering Up the System

Make sure the volume settings of the MOTIF XF and external devices such as powered speakers are turned down to the minimum before turning the power on. When connecting the MOTIF XF to the powered speakers, turn on the power switch of each device in the following order.

### When turning the power on:

First, the MOTIF XF, then the connected powered speakers.

### When turning the power off:

First, the connected powered speakers, then the MOTIF XF.

Please keep in mind that the Power switch is located at the right side (from the view of the keyboard) of the AC IN socket on the rear panel of the MOTIF XF.

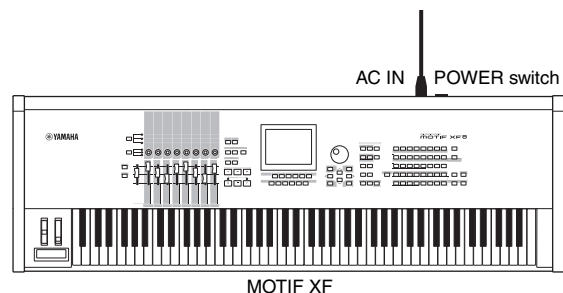



## Adjusting the Volume and the Brightness of the Display

Adjust the volume levels of the MOTIF XF and the connected amplifier/speaker system. If the display is not easily visible, use the Contrast control to adjust for optimum visibility.

Adjust the volume with the MASTER VOLUME slider.

Adjust the display contrast with the Contrast control.

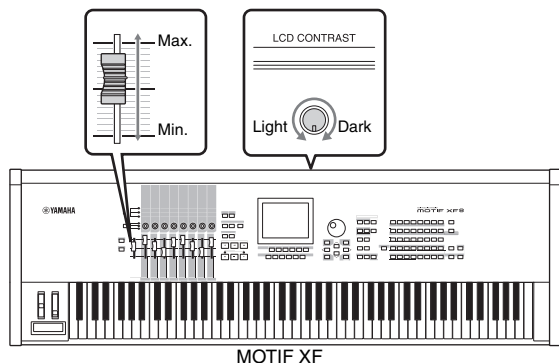

### CAUTION

Do not listen with the headphones at high volume for long periods of time. Doing so may cause hearing loss.

**NOTE** Keep in mind that the LCD display is not a touch screen type. Do not touch and press the display directly or forcefully.

## Listening to the Demo Song

Try listening to the preset Demo Songs, enjoy the high-quality sound, and get a taste for how you can use the MOTIF XF to create your own music.

### Playing the Demo Song

**1** Press the [SONG] button to enter the Song Play mode.

The Track View display of the Song Play mode appears.

**2** Press the SEQ TRANSPORT [▶] (Play) button to start the Demo Song.

The Song currently shown on the display starts.

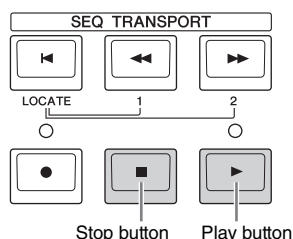

**NOTE** To adjust the volume level of the Demo Songs, use the MASTER VOLUME slider.

**3** Press the SEQ TRANSPORT [■] (Stop) button to stop the Demo Song.

## Selecting another Song

**1** Make sure that the cursor is located on the Song Number in the Track View display.

The highlighted frame within the display is called the "cursor." You can move the cursor up, down, left and right by using the Cursor buttons. If the cursor is located on another parameter, move the cursor to the Song Number.

Song number    Song name

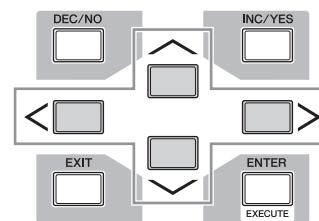

**NOTE** Keep in mind that the example displays shown in this manual are for instruction purposes only, and may appear somewhat different from those on your instrument.

**2** Press the [INC/YES] and [DEC/NO] buttons or rotate the data dial to change the Demo Song number.

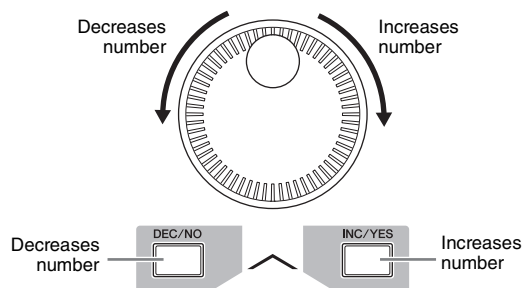

**NOTE** You can change the value of various parameters as well as the Song number by using the [DEC/NO]/[INC/YES] button or data dial after moving the cursor to the desired location. This basic operation is used for all of the selection and adjustment operations on the instrument.

## Loading the Demo data

In the default settings (when shipped from the factory), several Demo Songs and Patterns are stored to the instrument, starting at Song 01 and Pattern 01. However, you may delete them by recording your original data or loading a different Song/Pattern from an external USB storage device. To restore the original Demo data, follow the instructions below.

### NOTICE

Loading the Demo data overwrites all the Songs or Patterns. Before loading the Demo data, please check whether or not there is important data in the Songs or Patterns. If there is important data in the Songs or Patterns, save it to the external USB storage device or a computer on the network before loading the Demo data. For information about how to save, see page 64.

- 1 Press the [FILE] button and [UTILITY] button simultaneously.

The Demo Load display appears.

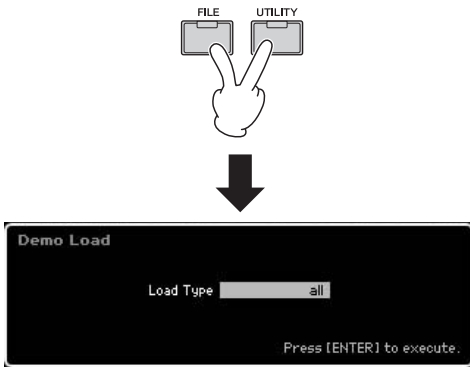

- 2 Make sure that the Load Type is set to “all,” then press the [ENTER] button to load the Demo data.

A display prompt appears to confirm whether or not the destination data (Song/Pattern) should be deleted.

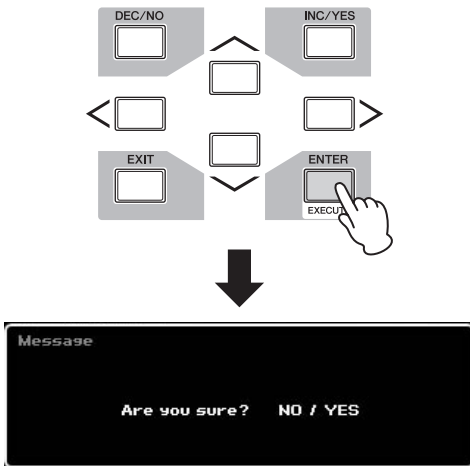

**NOTE** If you want to load only the Demo Song data, set the Load Type to “song.” If you want to load only the Demo Pattern data, set the Load Type to “pattern.”

### NOTICE

Loading the Demo data will overwrite all the Song/Pattern data already created and stored, regardless of the Load Type setting.

- 3 Press the [INC/YES] button to execute the Demo Load operation.

The Demo data is loaded to the Song and Pattern memory location, then the Song Play Track View display appears.

**NOTE** If you set the Load Type to “pattern” in step 2 above, the Pattern Play display appears after loading.

## Resetting the User Memory to the Initial Factory Settings

The original factory settings of this synthesizer’s User Memory can be restored as follows.

**NOTE** When connecting a computer to the MOTIF XF via a IEEE1394 cable, disable the driver used for this connection beforehand, and follow the procedure below to execute Factory Set.

### NOTICE

When the factory settings are restored, all the Voice, Performance, Song, Pattern, and system settings in the Utility mode you created will be erased. Make sure you are not overwriting any important data. Be sure to save all important data to your USB storage device or a computer on the network before executing this procedure (page 64).

- 1 Press the [UTILITY] button then the [JOB] button to call up the Factory Set display.

- 2 Set the check box of “All” to on, then press the [ENTER] button.

The display prompts you for confirmation. Press the [DEC/NO] button to cancel the Load operation.

- 3 Press the [INC/YES] button to execute the Factory Set.

After the Factory Set has been completed, a “Completed” message appears and operation returns to the original display.

### NOTICE

- For Factory Set operations that take longer to process, you will see the message “Now executing Factory Set...” during processing. While such a message is shown on the display, never attempt to turn off the power while data is being written to Flash ROM. Turning the power off in this state results in loss of all user data and may cause the system to freeze (due to corruption of data in the Flash ROM). This means that this synthesizer may not be able to start up properly, even when turning the power on next time.
- When entering a checkmark to the box of the Power On Auto Factory Set and executing the Factory Set, the Factory Set will automatically be executed each time turning the power on. Keep in mind that this also means that your original data in Flash ROM will be erased each time you turn on the power. Therefore, the checkmark of this box should normally be removed. If you remove the checkmark of this box and execute the Factory Set, the Factory Set will not be executed when turning the power on next time.

For details about the Factory Set, refer to “Resetting the User Memory to the Initial Factory Settings—[JOB] (Factory Set)” in the Reference Manual.

# Basic Operation

## Moving the Cursor

Use these four buttons to navigate the display, moving the cursor around the various selectable items and parameters in the screen. When selected, the relevant item is highlighted (the cursor appears as a dark block with inverse characters). You can change the value of the item (parameter) at which the cursor is located by using the data dial, [INC/YES] and [DEC/NO] buttons.

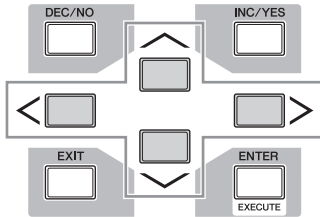

## Changing (editing) parameter values

Rotating the data dial to the right (clockwise) increases the value, while rotating it to the left (counter-clockwise) decreases it. For parameters with large value ranges, you can increase the value by 10 by simultaneously holding down the [INC/YES] button and pressing the [DEC/NO] button.

To decrease by 10, do the opposite; simultaneously hold down the [DEC/NO] button and press the [INC/YES] button.

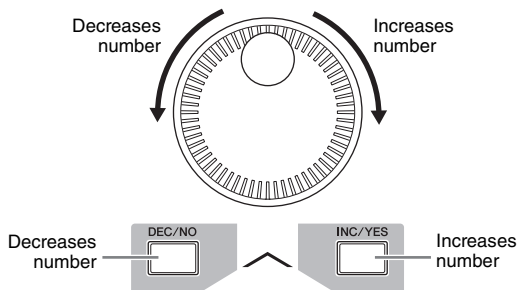

## Functions and Sub-Functions

Each mode described above contains various displays, with various functions and parameters. To navigate your way through these displays and select a desired function, use the [F1] – [F6] buttons and the [SF1] – [SF5] buttons. When you select a mode, the available displays or menus appear directly above the buttons at the bottom of the display (as shown below).

Depending on the currently selected mode, up to six functions are available and can be called up with the [F1] – [F6] buttons. Keep in mind that the available functions differ depending on the selected mode.

Depending on the currently selected mode, up to five functions (sub-functions) are available and can be called up with the [SF1] – [SF5] buttons (the [SF6] button is used mainly to call up the INFO and LIST displays). Keep in mind that the available functions differ depending on the selected

mode. (Some displays may not have any sub-functions for these buttons.)

The example display below is called up by pressing the [F5] button then pressing the [SF1] button.

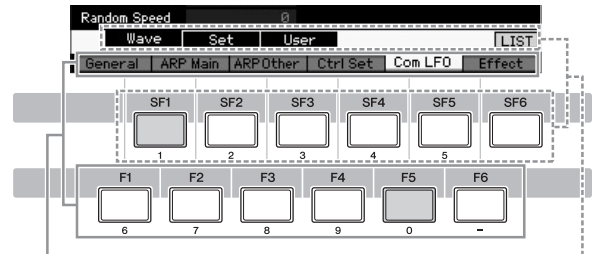

These functions can be selected via the corresponding button ([F1] – [F6]).

These functions can be selected via the corresponding button ([SF1] – [SF6]).

## Inputting a number directly

For parameters having large value ranges (such as the start and end points of a sample), you can also enter the value directly, using the buttons below the LCD display as a numeric keypad. When the cursor is located on such a parameter, the [NUM] icon appears at the lower right corner of the LCD display. When the [SF6] NUM button is pressed in this status, each digit (1 – 9, 0) is assigned to the [SF1] – [SF5] and [F1] – [F5] buttons as shown below, allowing you to input a number directly by using these buttons.

Depending on the selected parameter, a negative value can be input. When such a parameter is selected and you wish to input a negative value, press the [F6] button (to which “-” is assigned) then use the [SF1] – [SF5] and [F1] – [F5] buttons.

After completing the number input, press the [ENTER] button to actually enter the number.

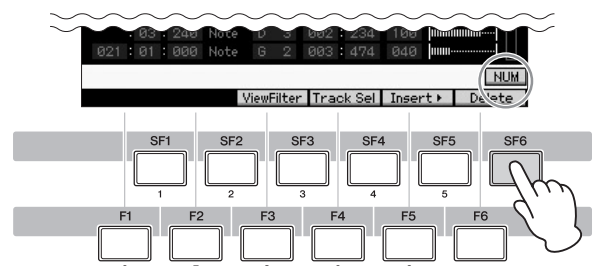

You can use these buttons as the numeric keypad.

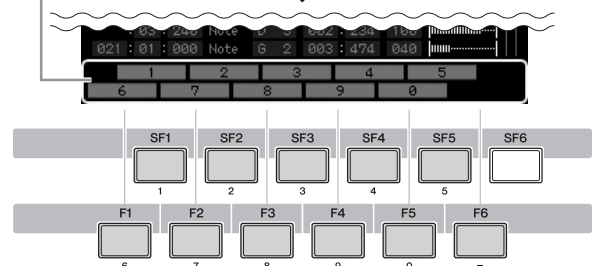



# Modes

There are several operation modes in the MOTIF XF, and they can be selected by using the nine mode buttons. These modes include: Voice, Performance, Song, Pattern, Mixing, Sampling and Master. Depending on the selected mode, you can play and perform on the keyboard and create your own original music.

If you want to play the keyboard conventionally, use the Voice or Performance mode. If you're creating music, particularly multi-part arrangements, use the Song or Pattern mode. In addition, the following modes are available: the Utility mode for making overall settings and the File mode for managing files for saving the data you created on this synthesizer and recording your keyboard performance as audio data and playing back audio files.

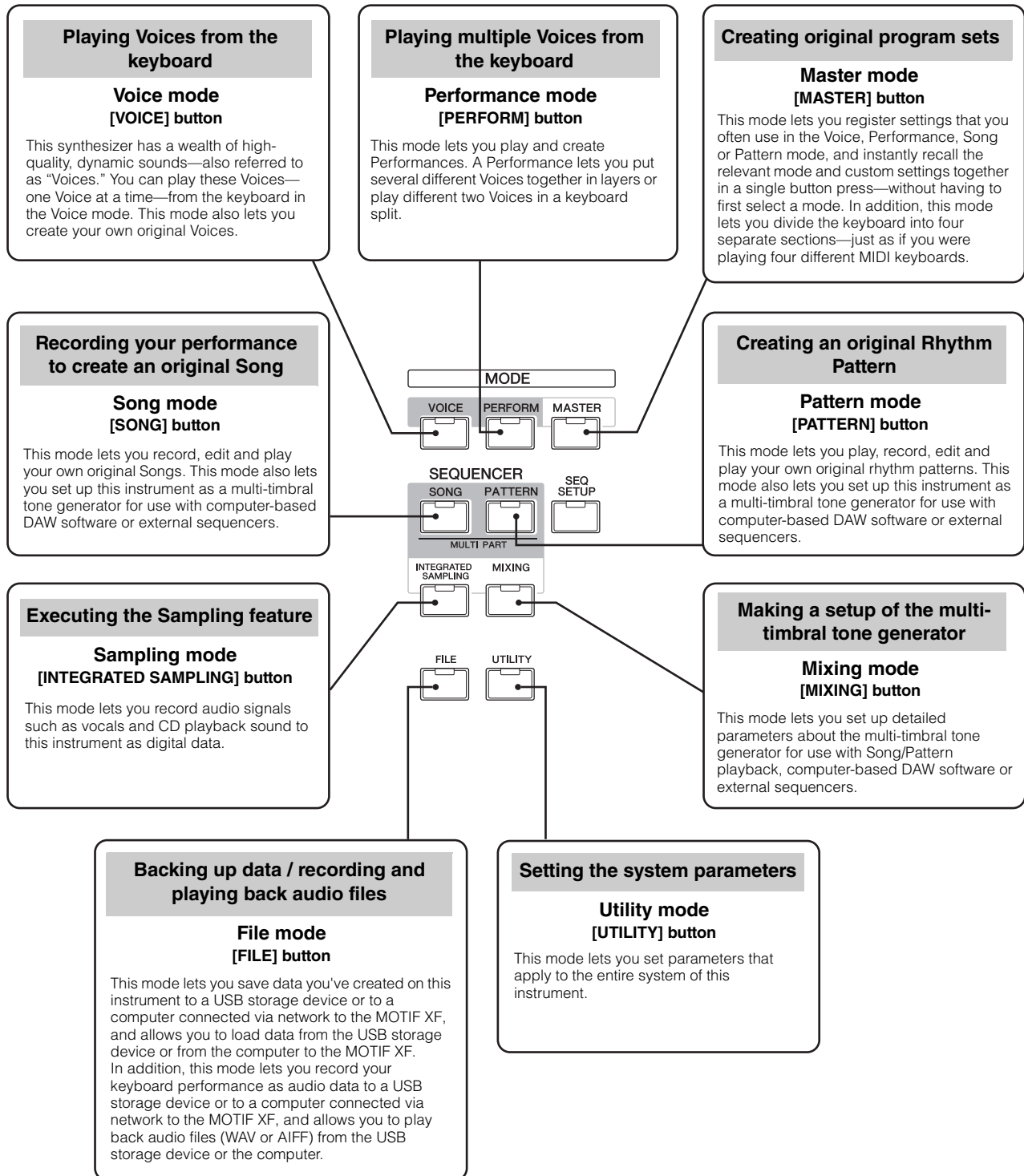

For more information, refer to the “Function Tree” in the Reference Manual.

# Playing the Keyboard in the Voice mode

In the Voice Play display (the top display of the Voice mode), you can select and play a single Voice. The Voices of this instrument are divided into the following two types:

## Normal Voices

Normal Voices are mainly pitched musical instrument type sounds (piano, organ, guitar, etc.) that can be played over the range of the keyboard.

## Drum Voices

Drum Voices are mainly percussion/drum sounds that are assigned to individual notes. These Voices are used to perform rhythm parts.

This instrument features Banks for memorizing Voices. There are basically three different types of Banks: Preset, User, and GM. The contained Voices and features depend on the Bank as described below.

## Preset Banks

The Preset Banks contain a full set of specially programmed Voices. Voices you've edited yourself cannot be saved in the Preset Banks.

## User Banks

The User Banks contain the Voices you have edited and stored. The Voices of User Bank 1 are those of your original creation, while the Voices of User Banks 2 – 4 are picked up from Preset Voices by default. The Voices No. 1 – 8 of the User Drum Bank are those of your original creation, while the Voices No. 9 – 32 of the User Drum Bank are picked up from Preset Voices by default.

### NOTICE

If a Voice in a User Bank (User Voice) is overwritten or replaced, that User Voice will be lost. When you store an edited Voice, be careful not to overwrite any important User Voices.

## GM Bank

The GM Bank contains the Voices allocated according to the GM standard.

### GM Voice

GM (General MIDI) is a worldwide standard for Voice organization and MIDI functions of synthesizers and tone generators. It was designed primarily to ensure that any song data created with a specific GM device would sound virtually the same on any other GM device—no matter the manufacturer or the model. The GM Voice bank on this synthesizer is designed to appropriately play back GM song data. However, keep in mind that the sound may not be exactly the same as played by the original tone generator.

In the Voice mode, a total of 16 Banks (Preset Bank 1 – 8, User Bank 1 – 4, GM Bank, Preset Drum Bank, User Drum, GM Drum Bank) are available. Each of these Banks includes

the Voices according to the Voice type. In the Voice Play display, you can select the desired Voice from various Voice Banks and play it.

**NOTE** For details about the Voice, refer to "Basic Structure." For a list of the Preset Voices, refer to the separate Data List PDF file.

## Selecting a Preset Voice

### 1 Press the [VOICE] button.

This calls up the Voice Play display. (The [VOICE] button lamp lights.)

### 2 Press the [PROGRAM] button so that the lamp lights then press one of the Bank buttons to select a Voice Bank.

In this condition, playing the keyboard sounds the Voice indicated in the display. The parameters shown in the Voice Play mode are briefly explained below.

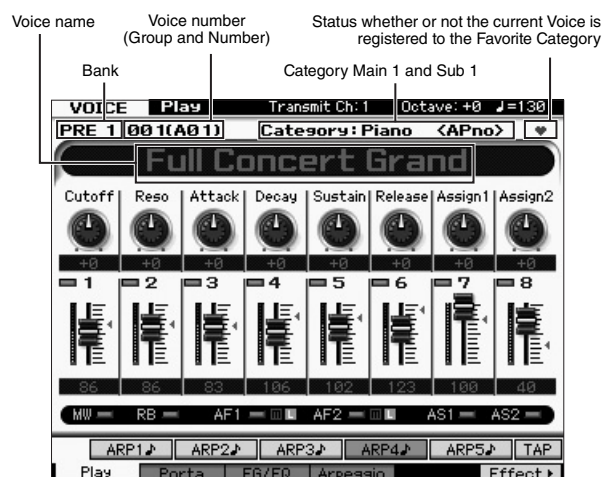

**NOTE** The above display appears when the Type is set to "1" and the Name Position is set to "TOP" at the VOICE line in the display called up via the [UTILITY] → [F1] General → [SF2] Screen. You can change this parameter setting by pressing any of the Cursor buttons while holding the [EXIT] button. This operation lets you call up the desired one from four types of the display design provided in the MOTIF XF.

### Normal Voice Banks

There are 13 different banks for the Normal Voices: PRE1 – 8 (Preset Banks), GM (GM Bank), USR1 – 4 (User Banks).

### Drum Voices Banks

There are 3 different banks for the Drum Voices: PDR (Preset Drum Bank), GMDR (GM Drum Bank), UDR (User Drum Bank).

### 3 Press one of the Group buttons [A] – [H] then press one of the Number buttons [1] – [16] to select a Voice.

**NOTE** You can use the data dial or [DEC]/[INC] buttons to select the Voice number. This operation lets you call up Voices in subsequent or previous Banks.

### 4 Play the keyboard.

## Using the Category Search function

The Voices are conveniently divided into specific Categories, irrespective of their bank locations. The categories are divided based on the general instrument type or sound characteristics. The Category Search function gives you quick access to the sounds you want.

### 1 Press the [CATEGORY SEARCH] button in the Voice Play display.

The Category Search dialog appears.

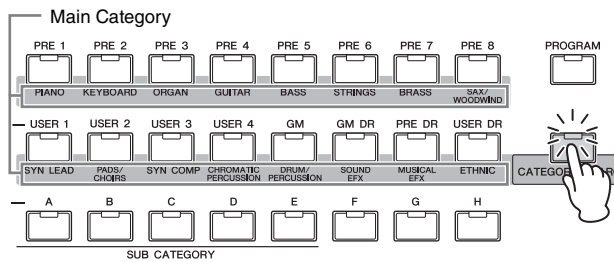

### 2 Move the cursor position to “Main” (Main Category) with the Cursor [<] button, and use the data dial to select the Main Category.

### 3 Move the cursor position to “Sub” (Sub Category) with the Cursor [>] button, and use the data dial to select the Sub Category.

### 4 Move the cursor position to “Voice List” with the Cursor [>] button, and use the data dial to select the Voice.

If you want to change the Category or Sub Category, press the Cursor [<] button to go back to step 2 or 3.

### 5 Press the [ENTER] button to actually call up the selected Voice.

This closes the Category Search dialog.

Below is a list of the Categories and their panel abbreviations.

Abbreviation	Category
Piano	Piano
Keys	Keyboard instruments (Harpsichord, Clav, etc.)
Organ	Organ
Guitr	Guitar
Bass	Bass
Strng	Strings
Brass	Brass
SaxWW	Saxophone and other woodwind instruments
SynLd	Synth Lead
Pads	Synth Pad
SyCmp	Synth Comp
CPerc	Chromatic Percussion (Marimba, Glockenspiel, etc.)
Dr/Pc	Drum/Percussion
S.EFX	Sound Effect
M.EFX	Musical Effect
Ethnc	Ethnic

## Using the Arpeggio function

This function lets you trigger rhythm patterns, riffs and phrases using the current Voice by simply playing notes on the keyboard. Since the preset Voices already have their own Arpeggio types pre-assigned, all you need to do is select the desired Voice and turn on the Arpeggio function. For certain Voices, simply selecting the Voice will turn Arpeggio on.

Try selecting different Voices and check out the various Arpeggio types.

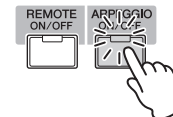

For example, select the Voice numbered “A01” of the Preset Drum Bank, turn the [ARPEGGIO ON/OFF] button on, then hold down a key (any key) on the keyboard, and listen as a rhythm is played automatically. The rhythm stops when you release the key.

Other preset Voices also have their own appropriate Arpeggio types for automatic playing of arpeggio/rhythm patterns. Up to five Arpeggio types can be assigned to the [SF1] – [SF5] buttons for each Voice.

When a certain Voice is selected, the same sequence is played back both regardless of the pressed note or notes. When a certain Voice is selected, on the other hand, the different sequence is played back depending on which notes are played or how they are played. Check out how Arpeggios are played back for different Voices by selecting various Voices and playing notes in various ways.

### Transmitting Arpeggio playback as MIDI data

The Arpeggio phrase can be transmitted as MIDI data by setting the following parameters to on:

#### ■ Voice Arpeggio

Voice mode → [UTILITY] → [F3] Voice → [SF3] Arpeggio → “ARP MIDI Out Switch”

#### ■ Performance Arpeggio

Performance mode → [EDIT] → select a Part → [F3] ARP Other → “MIDI Out Switch”

#### ■ Song/Pattern Arpeggio

Song mode/Pattern mode → [MIXING] → [EDIT] → select a Part → [F3] ARP Other → “MIDI Out Switch”

**NOTE** The transmit channel for Arpeggio can be set at the “MIDI Out Channel” parameter in the same display as “MIDI Out SW.”

### Setting the Arpeggio Tempo by using the Tap button

The Arpeggio playback tempo can be changed by pressing the [SF6] TAP button in the Voice Play display. Press this button several times at the desired tempo.



**NOTE** This Tap function is available also in the top display of the Performance/Song/Pattern/Master mode.

## Changing the Arpeggio type

The Arpeggio type assigned to each of the [SF1] – [SF5] buttons can be changed as desired.

### 1 From the Voice Play display, press the [F4] button to call up the Arpeggio display.

These global parameters apply to all the [SF1] – [SF5] buttons as a group.



These parameters can be set for each of the [SF1] – [SF5] buttons.

### 2 Press one of the [SF1] – [SF5] buttons.

The lower half of the display will be changed for the pressed button. The upper half of the display is common to all the [SF1] – [SF5] buttons.

### 3 In the lower half of the display, select the Category, Sub Category and Type of the Arpeggio.

The Category determines the instrument type, the Sub Category determines the rhythm type, and the Type determines the Arpeggio type itself. Press any note to trigger the Arpeggio playback to find your favorite one.

Go on and assign Arpeggio types in the same way to the other [SF] buttons as desired.



## Using the Controllers

The MOTIF XF gives you an amazing amount of control options. Not only is it equipped with conventional Pitch Bend and Modulation Wheels, it also features an extensive array of special Knobs, Sliders, Ribbon Controller, and Assignable Function buttons.

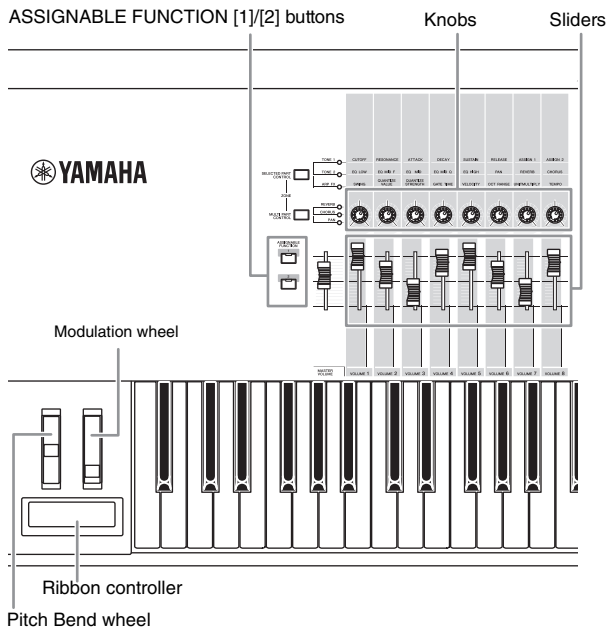

The Voice Play display lets you confirm the assignment status for each of the six Controllers—in other words, whether or not the specific function is assigned. (See the controller assignment chart below.) Keep in mind that the name of the Voice may include an abbreviation of the controller most suitable for use when playing the Voice.

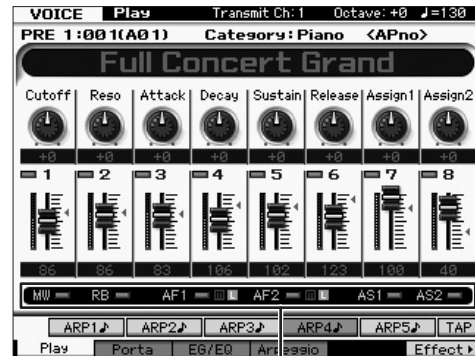

Indicates the controller assignment

Display	Description
AS1, AS2	Indicates whether or not the specific function is assigned to the knobs 7 (AS1) and 8 (AS2) respectively when the TONE 1 lamp is turned on.
AF1, AF2	Indicates whether or not the specific function is assigned to the ASSIGNABLE FUNCTION [1] and [2] buttons respectively. When the "m" indicator is turned on, pressing/holding the button turns the lamp on and releasing the button turns the lamp off. When the "L" indicator is turned on, pressing the button alternates the lamp status between on and off.
MW, RB	Indicates whether or not the specific function is assigned to the Modulation Wheel and Ribbon Controller respectively.

## Using the Knobs

Try using the Knobs with your left hand while playing the keyboard with your right with the Voice A01 "Full Concert Grand."

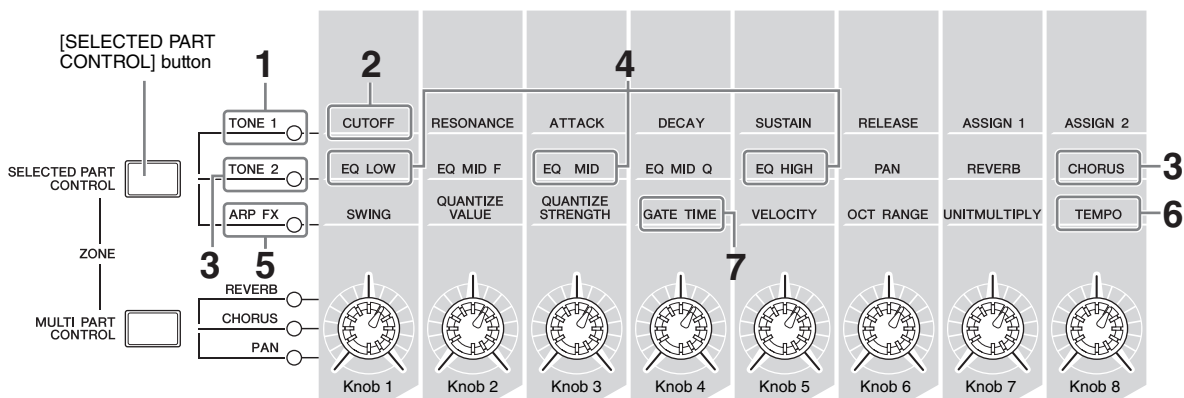

### 1 Press the [SELECTED PART CONTROL] button a few times so that the TONE 1 lamp lights.

The Control Function window appears when a display other than the Voice Play display is shown. You can also turn on the TONE 1 lamp by holding down the [SELECTED PART CONTROL] button.

### 2 Rotate the Knob 1 (at the far left) while playing the keyboard.

Turning the knob clockwise results in a brighter sound, while turning it counterclockwise results in a softer, muffled sound.

The sound changes in this way because Knob 1 is assigned to the Cutoff Frequency parameter (labeled CUTOFF in the matrix above Knob 1 and next to TONE 1).

**NOTE** The functions assigned to each of Knobs and current values are shown in the display.

Functions assigned to Knobs



- 3 Press the [SELECTED PART CONTROL] button a few times so that the TONE 2 lamp lights, then rotate the Knob (at the far right).**

The CHORUS (as printed above the Knob) is applied to the current Voice.

**NOTE** A red point on the Knob or Slider graphic indicates the current value to which the Knob or Slider is set. Moving the Knob or Slider has no effect on the sound until this point is reached. Once you move the Knob or Slider past this point, the red point disappears and moving the Knob or Control Slider affects the sound.

- 4 Turn Knob 1, Knob 3, and Knob 5 with the TONE 2 lamp turned on.**

You can change the sound by boosting or attenuating the LOW, MID and HIGH band (as printed above the Knobs respectively) of the EQ (equalizer).

- 5 Press the [SELECTED PART CONTROL] button a few times so that the ARP FX lamp lights, turn [ARPEGGIO ON/OFF] on, then turn the Knobs with your left hand while playing the notes with your right hand.**

In this status, all the Knobs can be used to change how the Arpeggio is played back.

Then, turn the [ARPEGGIO ON/OFF] button ON and operate the Knobs with your left hand while holding the keys with your right hand.

- 6 Rotate Knob 8 (at the far right) while playing the keyboard to change the tempo of the Arpeggio.**

- 7 Rotate Knob 4 to change the gate time of the Arpeggio notes, for example, from staccato to legato playback.**

Try out other Knobs as well.

**NOTE** For more information about the functions assigned to the Knobs in the Voice mode, refer to the Reference Manual.

By using the Knobs in this way, you can change the sound of the Preset Voice to create your own original Voice.

**NOTE** Controlling the knobs does not affect some Voices.

#### The Edit [E] Indicator

When changing the value of the parameter in the Voice Play or Edit display, the Edit Indicator will appear on the top right corner of the LCD. This gives a quick confirmation that the current Voice has been modified but not yet stored. To store the current edited status, execute the Store operation (page 27).

## Voice Editing

“Editing” refers to the process of creating a Voice by changing the parameters that make up the Voice. This can be done in Voice Edit, a sub mode within the Voice mode. The actual parameters that are available differ depending on the Voice type.

### Normal Voice Edit

A Normal Voice (pitched musical instrument-type sounds) can consist of up to eight Elements. There are two types of Voice Edit displays: Common Edit, for editing the settings common to all eight Elements; and Element Edit, for editing individual Elements.

#### About Elements

An Element is the basic and the smallest unit for a Voice, and is created by applying various parameters (Effect, EG, etc.) to the waveform of the instrument sound. Each Voice of this instrument consists of several Elements.

### Drum Voice Edit

There are two types of Drum Voice Edit displays: Common Edit, for editing the settings that apply to all Drum keys in the Voice; and Element Edit, for editing individual keys (Elements).

For details about Voice Edit, refer to the Voice mode chapter in the Reference Manual.

## Enhancing the sound with Effects

This instrument features a wide variety of Effects, letting you add reverb and chorus processing to the selected Voice for your keyboard performance. Simply changing the Effect type applied to the preset Voice lets you instantly come up with different sounds. The instructions below explain how to set the Effect type and the related parameters applied to the Preset Voice then store the settings as a User Voice.

- 1 Press the [VOICE] button to enter the Voice Play mode.
- 2 Select the Voice for which you wish to change or edit the Effect.
- 3 Press the [F6] Effect button.  
The Effect Connect display appears.

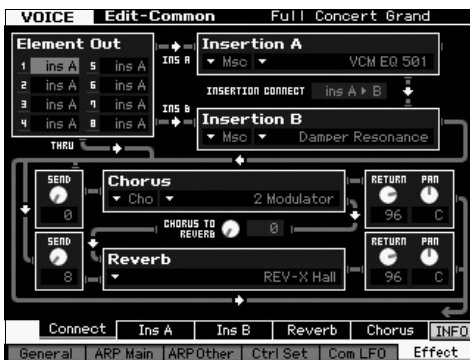

- 4 Move the cursor to "Insertion A."
- 5 In the "Insertion A" box, select the Effect Category at the left area then select the Effect Type at the right area.
- 6 Press the [SF2] Ins A button to call up the display which lets you set detailed parameters of the Effect Type specified in step 5.



- 7 Move the cursor to "Preset" then select the template by using the Data dial.  
Each of the templates includes the typical settings of parameters for the currently selected Effect Type. Try out several templates so that you can find how each Effect affects the sound.

- 8 If desired, set each of the parameters.  
Try narrowing in on the desired sound by finely editing the parameters provided for each Effect Type.

For details about the Effect parameters, refer to the "Basic Structure" in the Reference Manual.

## Storing the edited Voice

- 1 After editing the Voice, press the [STORE] button to call up the Voice Store window.

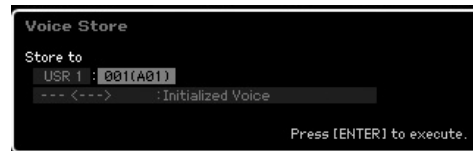

- 2 Set the destination for storing the Voice.  
Select the destination User Bank (USR 1 – 4 for the Normal Voice, UDR for the Drum Voice) and the Voice number to be stored by using the data dial, [INC/YES] and [DEC/NO] buttons. You can also use the [USER 1] – [USER 4], [USER DR], Group [A] – [H], and Number [1] – [16] buttons to specify the destination.
- 3 Press the [ENTER] button. (The display prompts you for confirmation.)  
To cancel the Store operation, press the [DEC/NO] button.
- 4 Press the [INC/YES] button to execute the Store operation.  
After the Voice has been stored, a "Completed" message appears and operation returns to the Voice Play display. In this condition, the just edited/stored Voice is selected as shown in the display, letting you instantly play the Voice.

**NOTICE**  
If you are editing a Voice and you select a different Voice without storing the one being edited, all the edits you've made will be erased.

**NOTICE**  
When you execute the Store operation, the settings for the destination memory will be overwritten. Important data should always be saved to a USB storage device connected to the USB TO DEVICE terminal. For instruction about the Save operation, see page 64.

For more information about the Voice, refer to the Voice mode chapter in the Reference Manual.

# Playing the Keyboard in the Performance mode

As in the Voice Play mode, the Performance Play mode is where you select and play the instrument sounds of this synthesizer. However, in the Performance mode, you can mix several different Voices together in a layer, or split them across the keyboard, or even set up a combination layer/split. Each Performance can contain up to four different Parts. Press the [PERFORM] button to enter the Performance Play mode.

## Selecting a Performance

Selecting a Performance is done in basically the same way as selecting a Voice. The Category Search function is available also in the Performance Play mode. Note that the MOTIF XF has no Preset Performances and provides only three User Banks. Consequently, press any of the [USER 1] – [USER 4] buttons to select a Performance after pressing the [PROGRAM] button.

## Performance Play mode indications

The Performance Play display indicates the Voice names for each of four parts making up the Performance at the bottom right corner. Except for this, the display is almost same as in the Voice Play mode.

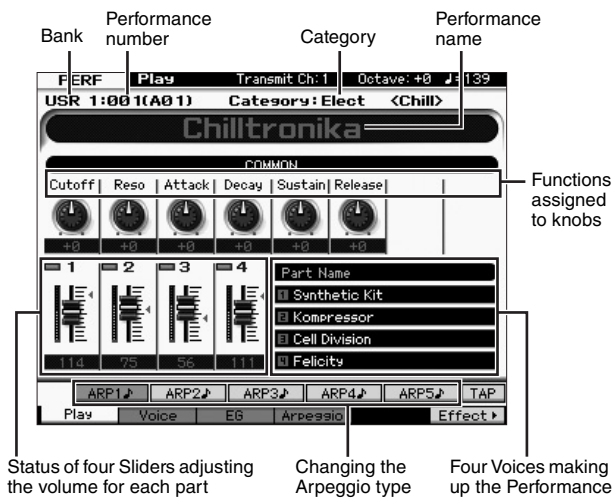

**NOTE** The above display appears when the Type is set to "1" in the [F6] Screen display of the Utility mode. You can change this parameter setting by pressing any of the Cursor buttons while holding the [EXIT] button. This operation lets you call up the desired one from four display design types provided in the MOTIF XF.

## Using the Controllers and Knobs

As in the Voice Play mode, you can change the tonal characteristics by using the controllers and knobs in the Performance mode.

Try selecting a Performance and operating the controllers and knobs.

## How Voices are assigned to Parts of a Performance

By default (when shipped from the factory), various types of Performances are provided in the User Banks. For some of these Performances, it may not be immediately obvious how to play them or use them, since they are more complicated than normal Voices. In this section, you'll learn the typical ways in which Performances are created, and thus better understand how to play and use them.

Each Performance can contain up to four different Parts. This section covers the typical four types of Voice assignments to these four parts.

### Performance Structure Layer

This method lets you play multiple (two or more) Voices simultaneously by pressing any notes. In the Performance mode, you can create a thicker sound by combining two similar Voices—for example, two different Strings Voices, each with a different attack speed.

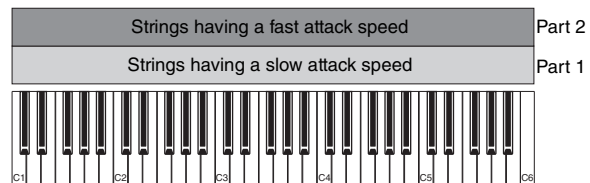

### Performance Structure Split by Note range

This method lets you play different Voices with your left hand and right hand. By assigning the Strings to the lower range and assigning the Flute to the higher range separately as illustrated below, you can play the Strings as accompaniment with your left hand and play the Flute as melody with your right hand.

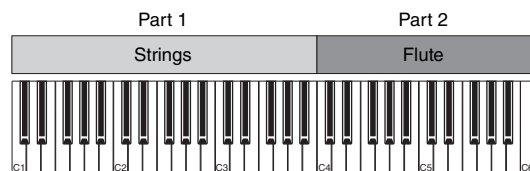

### Performance Structure Split by Velocity range

This method lets you trigger different Voices depending on your playing strength (velocity). In this example below, playing the note with low velocities triggers Strings sounds with a slow attack speed. Playing the note with middle

velocities triggers Strings sounds with a fast attack speed. Playing the note with high velocities triggers Orchestra Hits.

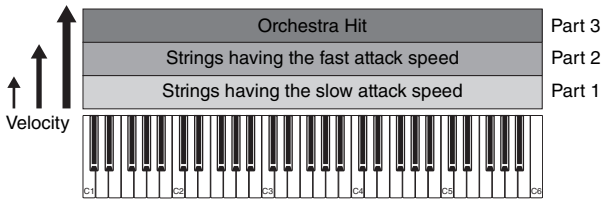

**Performance Structure**      **Using the Arpeggio**

With this method, you can play all the parts of a band by yourself. This type of Performance also uses different Arpeggio types assigned to the individual Parts, making it even easier to sound like a full band. In the example below, the Drum pattern (by Arpeggio) will be played back indefinitely even when you release the notes, the Bass line (by Arpeggio) will be played back by your left hand performance, and the Guitar backing (by Arpeggio) or Piano Arpeggio will be played back by your right hand performance.

In addition, you can change the Arpeggio Type assignment for each Part by pressing any of the [SF1] – [SF5] buttons.

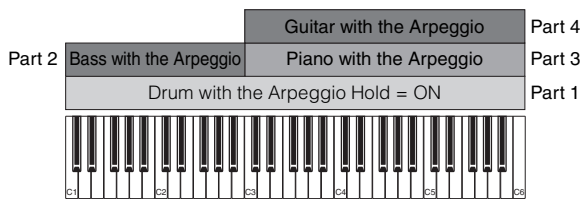

Using or combining the four methods described above gives you the ability to create a rich variety of Performances. By default, many Performances stored in the User Banks may be created via the above methods. Try out various Performances and see which method is used for each.

## Creating a Performance by combining Voices

After checking out the pre-programmed Performances in the User Banks, try creating your own original Performance. In this section, we'll create a Performance by combining two Voices.

### Preparing to create a Performance (Initializing the Performance)

- 1 In the Performance Play mode, press the [JOB] button, and then the [F1] button.**  
The Initialize display is shown. Make sure that the check box of "All Parameters" is checked.
- 2 Press the [ENTER] button. (The display prompts you for confirmation.)**
- 3 Press the [INC/YES] button to initialize the Performance.**

#### 4 Press the [PERFORM] button.

The current Performance name will change to "Initialized Perform" in the display.

**NOTE** When you initialize a Performance, the Voice at Preset Bank 1, Voice number 1 is assigned to each of all Parts and all the Parts are turned on by default.

## Playing several Voices together (Layer)

Try combining two Voices by assigning your favorite Voice to Part 2.

- 1 In the Performance Play display, press the [F2] button to call up the Voice display.**  
From this display, you can confirm what Voices are assigned to the Parts. You can also confirm that all the Parts are turned on after executing the Initialize function above.
- 2 Move the cursor to the checkbox of the PART 2 then press the [INC/YES] button to enter the checkmark.**
- 3 Move the cursor to the VOICE, then select the desired Voice by setting a Bank and Voice number.**

**NOTE** From this display, you can use the Category Search function to select a Voice. Like in the Voice mode, use the [CATEGORY SEARCH] button. Please note that the category names printed below the Bank buttons correspond not to the Performance Category but to the Voice Category.



#### 4 Play the keyboard.

The Part 1 (Piano Voice) and Part 2 (the Voice you have selected above) are sounded simultaneously in a layer.

Next, let's play different Voices with the left and right hands.

## Split

You can play different Voices with the left and right hands by assigning one Voice to Part 1, with a note range in the lower section of the keyboard, and a different Voice to Part 2, with a note range in the higher section of the keyboard.

- 1 Move the cursor to the NOTE LIMIT HI of Part 1.**
- 2 Set the highest note of Part 1 by pressing the corresponding key while holding the [SF6] KBD button.**  
The illustration of the keyboard indicates the specified note range in color.

- 3 Move the cursor to the NOTE LIMIT LO of the Part 2.
- 4 Set the lowest note of Strings sounds with a Part 2 by pressing the corresponding key while holding the [SF6] KBD button.

The illustration of the keyboard indicates the specified note range in color.

5 Play the keyboard.

The notes you play with your left hand sound the Piano Voice (Part 1), while the notes you play with your right hand sound the different Voice (Part 2) you have selected.

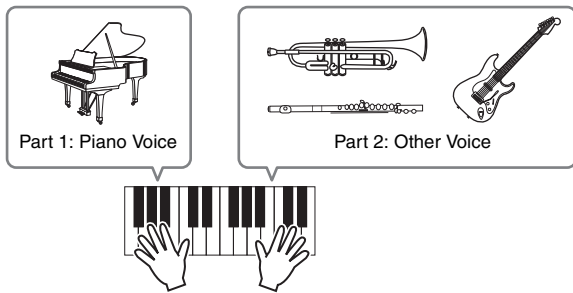

### Adjusting the Part levels

Adjust the Volume settings of Parts 1 and 2 by using the Control sliders.

### Changing the Arpeggio settings for each Part

Try changing the Arpeggio settings for each Part. You can assign the rhythm or backing pattern that best matches the desired style of music to the Performance.

- 1 From the Voice Play display, press the [F4] button to call up the Arpeggio display.
- 2 Select the desired Arpeggio by pressing one of [SF1] – [SF5] buttons.

The lower half of the display will change depending on the pressed button. The top of the display (Common Switch, Sync Quantize Value and Tempo) is common to all the Sub Function buttons.

Settings common to the [SF1] – [SF5] buttons



Step 2

3 Select the Category, Sub Category and Type of the Arpeggio for each of the Parts 1 – 4.

The Category determines the instrument type, the Sub Category determines the rhythm type, and the Type determines the Arpeggio type itself. Set the BANK to "PRE" when using a Preset Arpeggio type.

Note that the Arpeggio Hold parameter is useful as well as the Arpeggio type selection. When this parameter is set to "on," the Arpeggio playback continues even if the note is released. This parameter should be set to "on" when the Drum Voice is assigned to the Part and you wish to have playback of the Arpeggio (rhythm pattern) continue regardless of whether you hold the note or not.

Arpeggio Hold parameter



**NOTE** Categories and Sub Categories can easily be selected by calling up their respective lists on the display. When moving the cursor, for example, to the Category and pressing the [SF6] button, the Category List appears at the cursor location. You can select the desired one by using the data dial, [INC/YES] and [DEC/NO] buttons. After selecting, pressing the [ENTER] button actually calls up the selected Arpeggio type. This operation is very useful and convenient in selecting from the huge variety of available Arpeggios.

Go on and assign Arpeggio types in the same way to the other [SF] buttons as desired.

### Storing the Performance

After editing, make sure to store the created Performance to internal memory by pressing the [STORE] button to call up the Performance Store window.

The Store operation is the same as that of Voice Store (page 27).

■ NOTICE ■

If you are editing a Performance and you select a different Performance without storing the one being edited, all the edits you've made will be erased.

■ NOTICE ■

The preset data of the Performances is stored in the User Bank memory. Storing the Performance data you've created erases the preset Performance data. If you wish to restore the preset data of the Performance, execute the Factory Set Job in the Utility mode, which results in the erasing of your original data. Consequently, make sure to save any important data to an external USB storage device to avoid losing important data.

For more information about Performances, refer to the Performance mode chapter in the Reference Manual.

# Recording in the Performance mode

While experimenting and playing around with Arpeggios in the Performance mode, you may find some rhythm patterns and phrases that you like, and you may want to store them for future recall. The best and easiest way to capture these is to record your keyboard playing to a Song or Pattern.

## Performance Record Structure

By using the Performance Record function, your keyboard performance for Parts 1 – 4 will be recorded to tracks 1 – 4 of the Song/Pattern respectively. Controller/Knob operations and Arpeggio playback as well as your keyboard playing in the Performance mode can be recorded to the specified track as MIDI events.

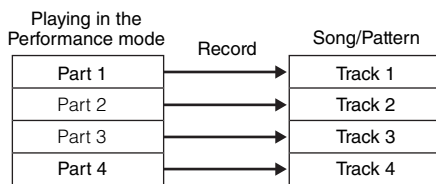

## Recording the Melody and Arpeggio playback to the Song

When the Song is selected as destination of the Performance recording, you can record your keyboard playing with the Arpeggio without having to worry about measure limits or running out of recording space. It is a good idea, for example, to record your keyboard playing, freely calling up various Arpeggio types, then editing the Song later as necessary. You may even want to keep the recorder 'running' as you improvise, then listen back later and pick out the best parts to create your final Song. Try recording as shown in the instructions below.

- 1 In the Performance Play mode, select a Performance for recording.**
- 2 Press the [ARPEGGIO ON/OFF] button so that the lamp lights.**

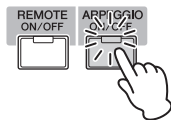

- 3 Press the [●] (Record) button to call up the Performance Record display.**

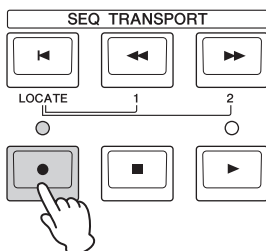

- 4 Set the following parameters as required in the Performance Record display.**



- 1 Sequencer Mode = "song"**

By setting this parameter to "song," you can record your keyboard performance to the Song.

- 2 Song number**

Select a destination song. Executing Performance recording overwrites and erases all the previously recorded data of the specified Song. Make sure to select a Song which contains no data.

- 3 Time Signature = "4/4"**

Set the same value here as that of the Arpeggio type. Normally, set this to "4/4."

- 4 Tempo**

Set the desired tempo of the metronome and Arpeggio for recording.

- 5 Key On Start Switch = (on)**

When set to "on," recording starts immediately when you press any note on the keyboard. Set this parameter to "on" when using the Arpeggio.

**NOTE** indicates the off status, whereas indicates the on status.

- 6 Copy Performance Parameters = on**

Enter the checkmark when you wish to copy the parameter settings for Parts 1 – 4 of the Performance to Parts 1 – 4 of the Song Mixing.

- 7 Click (on)**

Press the [F5] button to turn the metronome on if you wish to use the metronome.

- 5 Press any note to start recording.**

Play the keyboard in time with the metronome. You can change the Arpeggio type and settings by pressing any of the [SF1] – [SF5] buttons while recording.

- 6 Press the [■] (Stop) button to stop recording and return to the Performance Play display.**

## 7 After recording, press the [SONG] button to enter the Song Play mode, then play the recorded Song.

As desired, record the keyboard performance to another track in the Song Record mode and edit the recorded data in the Song Edit mode or Song Job mode to finalize the Song data. After finalizing the Song data, press the [STORE] button to store your original Song.

## Recording Arpeggio playback to a Pattern

If you record your keyboard playing along with Arpeggio playback in the Performance mode to a Pattern, you can quickly create full and complete rhythm patterns lasting just a few measures. These short patterns of MIDI sequence data can be played back repeatedly in a loop and then conveniently used as 'building blocks' for your original Songs.

Follow the instructions below, playing with your favorite Arpeggios in the Performance mode, and record your improvisations to a Pattern. Once you've recorded three or four good Patterns, you'll have enough building blocks to create a complete Song!

### 1 In the Performance Play mode, select a Performance for recording.

Find the Performance which triggers your favorite rhythm pattern or phrases via the Arpeggio.

### 2 Press the [ARPEGGIO ON/OFF] button so that the lamp lights.

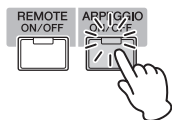

### 3 Press the [●] (Record) button to call up the Performance Record display.

### 4 Set the following parameters as required in the Performance Record display.



### 1 Sequencer Mode = "pattern"

By setting this parameter to "pattern," you can record your keyboard performance to the Pattern.

### 2 Pattern number

Select a destination Pattern number. Executing the Performance Recording overwrites and erases all the previously recorded data of the specified Pattern. Make sure to select a Pattern which contains no data.

### 3 Section

Select a Section to be recorded, from A – P. If you create several Sections, you can use them as rhythm variations within a single Song.

### 4 Section Length

Set the length of the Section to be recorded. Set the value to 1 – 4 according to the length of the current Arpeggio types.

### 5 Time Signature = "4/4"

Set the same value here as that of the Arpeggio type. Normally, set this to "4/4."

### 6 Tempo

Set the desired tempo of the metronome and Arpeggio for recording.

### 7 Key On Start Switch = IIII (on)

When set to "on," recording starts immediately when you press any note on the keyboard. Set this parameter to "on" when using the Arpeggio.

### 8 Copy Performance Parameters = on

Enter the checkmark when you wish to copy the parameter settings for Parts 1 – 4 of the Performance to Parts 1 – 4 of the Pattern Mixing.

### 9 Click (on)

Press the [F5] button to turn the metronome on if you wish to use the metronome.

## 5 Press any note to start recording. The recording stops when the end of the Pattern length is reached.

Recording stops returns to the Performance Play display. Please note that loop recording is not available in the Performance Record mode, although it is available in the Pattern Record mode.

## 6 After recording, press the [PATTERN] button to enter the Pattern Play mode then play the recorded Pattern.

Create several Sections in the Performance Record mode, then create a Pattern Chain by connecting the Sections together to create an entire Song. For details, see page 43.



# Audio Record/Playback

With the Audio Record / Play function, you can now record your performances on the MOTIF XF as WAV-format audio files (44.1-kHz, 16-bit, stereo) on a USB storage device or a computer connected via a network. What's more, the MOTIF XF can now also play WAV or AIFF audio files stored on a connected USB storage device or computer. Record and playback operations are done in the File mode, and these procedures are described in detail below.

## Recording your performance as audio

Your performances on the MOTIF XF can be recorded as 44.1-kHz, 16-bit, stereo audio files. The recording level is fixed, and it is possible to record continuously for up to 74 minutes (assuming that the USB storage device or computer has sufficient free memory).

### 1 If you want to record on a USB storage device, connect it to the USB TO DEVICE connector on the rear panel.

Alternatively, if you want to save your performances on a networked computer, set up File Sharing for accessing the computer from the instrument as described in "Network connection" of the Reference Manual.

### 2 Select the Voice, Performance, Song, or Pattern to be recorded by pressing the [VOICE], [PERFORM], [SONG], or [PATTERN] button and then using the data dial or the [DEC/NO] and [INC/YES] buttons.

If you select a Song or Pattern, be sure to also set the Parts to be recorded.

### 3 Press the [FILE] button and then the [F4] Audio button.

The File mode Audio display will appear.

### 4 Set the device and directory where your performances will be recorded using the cursor [^][v] buttons together with the data dial and the [DEC/NO] and [INC/YES] buttons.

Select the device connected in Step 1 above using the Device section (1), and navigate to the directory to be used to store your performances using the Directory section (2).

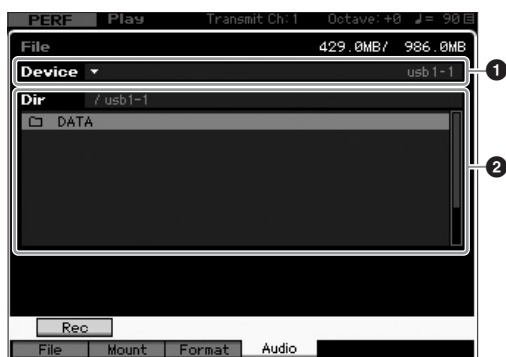

### 5 Press the [SF1] Rec button.

The Input Character window will be displayed.

**NOTE** If you selected a previously recorded audio file in the Directory section (2) before pressing the [SF1] Rec button, the name of that file will be automatically entered into the Input Character window.

### 6 Enter a file name and then press the [ENTER] button.

The STANDBY display will appear. File names may contain up to 20 alphanumeric characters. For detailed instructions on naming, refer to "Basic Operation" (page 20).

#### ■ NOTICE ■

If the Input Character window contains the name of a file already existing in the selected directory when you press the [ENTER] button, you will be asked to confirm whether or not you want to overwrite that file. Please note that if you press the [INC/YES] button in response, the file in question will be immediately deleted from the directory.

### 7 Set the required trigger level.

If you set the trigger level to "manual," recording will begin whenever you press the [ENTER] button. Alternatively, if you set a value between 1 and 127, recording will begin automatically whenever the playback volume exceeds that level. The level set here will be indicated by red triangles in the level meter. For best results, set this parameter as low as possible to capture the entire signal, but not so low as to record unwanted noise.



### 8 Press the [ENTER] button.

If you have set the trigger level to "manual," recording will begin immediately and the displayed status will change from "STANDBY" to "RECORDING." If you have set a value between 1 and 127 as the trigger level, the displayed status will change from "STANDBY" to "WAITING."

## 9 Play the keyboard.

If you set the trigger level to a value between 1 and 127, recording will begin automatically whenever the playback volume exceeds that level; furthermore, the displayed status will change from "WAITING" to "RECORDING" at that time. If you want to include the currently selected Song or Pattern in your recording, press the SEQ TRANSPORT [▶] (Play) button at any time to start playback. You can also press one of the Number buttons [1] – [16] while recording to change parts.

## 10 When you have finished playing, press the [ENTER] button once again.

Recording will end and the recorded audio file will be saved on the selected device.

### ■ NOTICE ■

The MOTIF XF or the selected storage device should never be turned off during recording or while the recorded audio file is being saved. Turning off either device at this time may make it impossible to subsequently access the storage device.

## Playing an audio file

Using the MOTIF XF, you can now playback WAV and AIFF audio files stored on a USB storage device or a networked computer

### 1 If you want to play an audio file on a USB storage device, connect it to the USB TO DEVICE connector on the rear panel.

Alternatively, if you want to play an audio file on a networked computer, setup File Sharing for accessing the computer from the instrument as described in "Network connection" of the Reference Manual.

### 2 Press the [FILE] button and then the [F4] Audio button.

The File mode Audio display will appear.

### 3 Select the device and the file to be played using the cursor [▲][▼] buttons together with the data dial and the [DEC/NO] and [INC/YES] buttons.

Select the device connected in Step 1 above using the Device section (1), and set the audio file for playback using the Directory section (2).



### 4 Press the [SF2] Play button.

The audio file will begin playing.

### 5 If necessary, you can adjust the playback volume using the data dial or the [DEC/NO] and [INC/YES] buttons.

### 6 To stop playback, press the [SF2] Stop button, the [ENTER] button, or the [EXIT] button.

Operation will return to the File mode Audio display.

**NOTE** Keep in mind that you can also play a desired Voice on the keyboard (selected in the Voice or Performance mode) during audio playback.

# Using as a Master Keyboard (Master Mode)

The Master mode lets you:

- Create and store up to 128 programs, each containing a Voice, a Performance, a Song or a Pattern—which can be instantly called up for use.
- Assign up to eight separate Zones in each Master program for use as a master keyboard.

You can use the Master mode to memorize the settings you use most often, including the information on which mode is used, and call up these settings instantly anytime you need them with a single button press. Furthermore, you can memorize the settings for controlling an external MIDI device by the Master, allowing you to change and control the connected external MIDI tone generator in sequence while performing live.

## Registering the Edited Voice/ Performance/Song/Pattern

It is a good idea to assign the Voice mode to one Master program number (for example, 001) and the Performance mode to the next numbered program (i.e., 002) if you want to quickly call up a specific Voice then a related specific Performance. Follow the steps below to store the program.

- 1 Press the [MASTER] button to enter the Master mode.**
- 2 Select a Master to be edited.**
- 3 Press the [EDIT] button to enter the Master Edit mode.**
- 4 Press the [COMMON EDIT] button to call up Common Edit, then press the [F2] Other button.**



- 5 Move the cursor to “Mode” then select the desired Mode (i.e., Voice mode).**
- 6 Move the cursor to “Memory” then select the desired program number (i.e., Voice number).**
- 7 Press the [STORE] button to store the created Master program.**

## Making settings for use as a master keyboard

In the Master mode, you can divide the keyboard into a maximum of eight independent areas (called “Zones”). Different MIDI channels and different functions of the Knobs and Control Sliders can be assigned to each Zone. This makes it possible to control several Parts of the multi-timbral tone generator simultaneously by a single keyboard or to control Voices of an external MIDI instrument over several different channels in addition to the internal Voices of this synthesizer itself—letting you use the MOTIF XF to effectively do the work of several keyboards. You can set the parameters related to the eight Zones in the Master Edit mode and store the settings as a User Master. There are two types of Master Edit displays: those for editing parameters common to all eight Zones and those for editing individual Zones.

- 1 Press the [MASTER] button to enter the Master mode.**
- 2 Select a Master to be edited.**
- 3 Press the [EDIT] button to enter the Master Edit mode.**
- 4 Press the [COMMON EDIT] button to call up Common Edit, then press the [F2] Other button.**



- 5 Move the cursor to “Zone Switch” then select “on.”**
- 6 Move the cursor “Knob Control Assign” then select “zone.”**

**7 Press the Number [1] button to enter Zone Edit.**

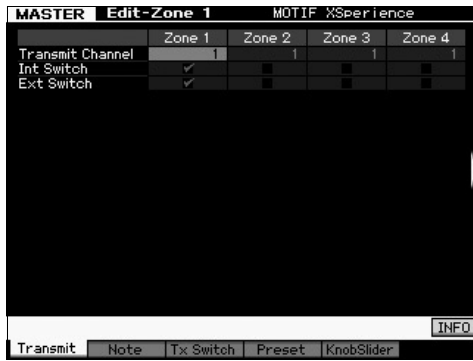

**8 Set the parameters for Zone 1 on each of the [F1] – [F5] displays.**

**9 Press one of the [2] – [8] buttons then set the parameters for Zone 2 – 8 on each of the [F1] – [F5] displays.**

**10 After setting all the desired parameters, press the [STORE] button to store your settings as a Master program.**

After completing these settings, assign a name to the Master in the [F1] Name parameter of the Master Common Edit display. After naming, press the [STORE] button to store the Master.

For more information about the Master mode, refer to the Master mode chapter in the Reference Manual.

# Creating an original Song

Now that you've learned some of the basic features of the MOTIF XF—including how to select Voices and Performances, play with the Arpeggios, and record your playing and Arpeggio playback to a Song or Pattern—you're ready to create your own original Song.

The MOTIF XF features a built-in multitrack sequencer for recording your keyboard performance as MIDI data. This function by itself is enough to create full, complex multi-instrument arrangements and complete Songs.

## Terminology

Below are some common terms used in Song recording that you may want to familiarize yourself with before beginning.

### Song

Songs and Patterns are MIDI sequence data consisting of up to 16 tracks. A Song on this synthesizer is effectively the same as a Song on a MIDI sequencer, and playback automatically stops at the end of the recorded data.

### Track

This is a memory location on the sequencer where your musical performances (made up of MIDI events) are stored. The MOTIF XF provides 16 tracks, which correspond to the 16 Parts of the Mixing.

### Mixing

This is a program in which multiple Voices are assigned to Parts for multi-timbral play in the Song and Pattern modes. Each Mixing can contain up to 16 parts and a separate Mixing can be created for each Song.

### Realtime Recording

With realtime recording, the instrument functions in the same way as a MD recorder, recording the performance data as it is played. This allows you to capture all the nuances of an actual performance. Realtime Record features three available methods: Replace, Overdub and Punch In/Out. Replace lets you overwrite an already recorded track with new data. Overdub lets you add more data to a track that already contains data. Punch In/Out lets you re-record only over a specific area of the track.

## Song Playback

Before you learn how to create a Song, you should know something about the mute/solo functions and how to use the sliders during Song playback. Call up a Demo Song (page 17) then try out the following operations while playing back the Demo Song.

### Track mute

You can mute a specific track or tracks of the Song.

#### 1 Press the [MUTE] button so that its lamp lights.

The lamps of the Number buttons light.

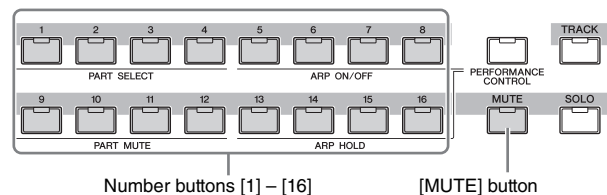

#### 2 Press any of the Number buttons [1] - [16] so that its lamp will be turned off and the corresponding track will be muted.

Multiple tracks can be muted simultaneously.

#### 3 Press the button which is turned off so that its lamp lights and the corresponding track will be sounded.

For future recording, make sure to turn off the Mute settings of all the tracks.

### Track solo

You can solo a specific track of the Song.

#### 1 Press the [SOLO] button so that its lamp lights.

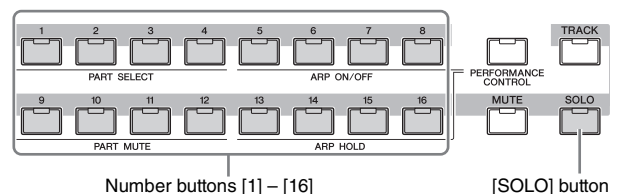

#### 2 Press any of the number buttons [1] - [16] so that its lamp flashes to solo the corresponding track.

Press another number button to change the soloed track.

#### 3 Press the [TRACK] or [MUTE] button to return to the original status.

## Adjusting the volume of each Part

You can adjust the volume for each of eight Parts, using the panel sliders.

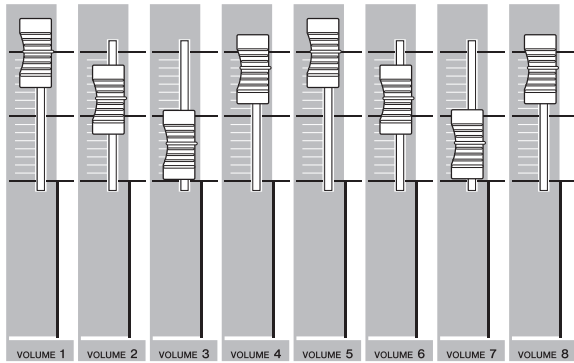

When one of Tracks 1 – 8 is currently selected, the eight sliders are used to adjust the volume for Parts 1 – 8. When one of Tracks 9 – 16 is selected, the sliders are used to adjust the volume for Parts 9 – 16. The track can be selected by turning the [TRACK] button on and pressing the desired Number button.

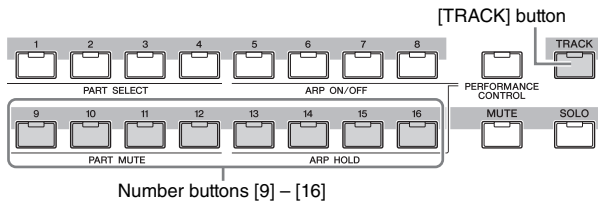

In addition to sliders, Knobs 1 – 8 can be used to affect the sound of the Song playback in real time. For details, refer to the Reference Manual.

## Recording to a track

Soon you'll record your keyboard performance, recording a part to Track 1. First though, you'll need to set up the MOTIF XF for realtime recording.

**1 Press the [SONG] button to enter the Song Play mode and then select a Song that contains no data.**

**2 Press the [RECORD] button to enter the Song Record mode.**

The Record Setup display appears.

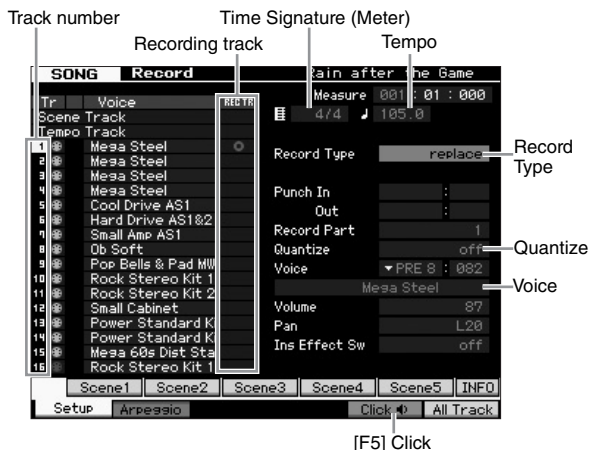

**3 Set the following parameters on the Record Setup display.**

**3-1** With the [TRACK] lamp turned on, press the Number button [1] to set the recording track to 1. The red circle symbol is shown at the REC TR column of Track 1. The Record Part is automatically set to 1.

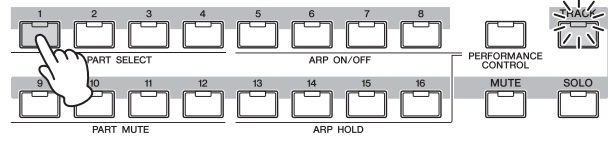

**3-2** Move the cursor to Time Signature (Meter) then set the value. Here, set this to "4/4."

**3-3** Move the cursor to Tempo then set the desired value. Here, set this to "144."

**3-4** Move the cursor to Record Type then select "replace." This method overwrites any previously recorded data.

**3-5** Set Quantize to "240." This convenient feature lets you automatically quantize (or "clean up" the timing of) the notes in real time, as you record. Quantize aligns the timing of note events to the nearest beat. Normally, the smallest note value in the notation sheet (you will play) should be set.

**3-6** Select the Voice for recording by specifying the Bank and Number. The value set here is applied to Part 1 of the Mixing.

**3-7** Press the [F5] button to turn the Metronome on . Pressing the [F5] button toggles the Metronome on and off.

**NOTE** The metronome related settings (such as note resolution, volume and pre-count measure number before recording) can be set in the Click display of the Sequencer Setup called up via the [SEQ SETUP] button. For details, refer to the Reference Manual.

**4 After completing recording setup, press the [▶] (Play) button to start recording.**

Press the [▶] (Play) button so that its indicator flashes, then actually start recording after the count-in.

**5 When you've finished playing, press the [■] (Stop) button to stop recording.**

If you've played any wrong notes, press the [■] (Stop) button, then try recording again. After recording your keyboard performance to Track 1, set the REC TR to 2 in the Recording Setup display, then record another performance to Track 2.

## Creating a Song by using Arpeggio

In addition to creating a Song by recording your keyboard performance conventionally, you can also use the powerful Arpeggio playback features.

Arpeggio phrases triggered simply by pressing any note can be recorded to a Song track.

**1 Press the [SONG] button to enter the Song Play mode.**

**2** Press the [ARPEGGIO ON/OFF] button so that the lamp lights.

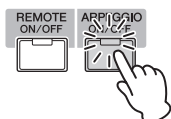

**3** Press the [RECORD] button to enter the Song Record mode.

**4** Press the [F1] button to call up the Record Setup display.



**5** Set the following parameters in the Record Setup display.

**5-1** To select the desired track, press the [TRACK] button (the lamp lights), then press the appropriate Number button [1] – [16].

**5-2** Set the Time Signature to “4/4.”

**5-3** Set the Quantize parameter to “off.”

**6** Press the [F2] button to call up the Record Arpeggio display.



**7** Set the following parameters as required in the Arpeggio Record display.

**7-1** Set the Switch parameter to on.

**7-2** Set the Voice with Arpeggio (ARP) parameter to on. When this is set to “on,” the Voice matching the selected Arpeggio type is automatically called up each time the Arpeggio type is changed.

**7-3** Select the Arpeggio type by specifying the Category, Sub Category and Type.

**8** After completing recording setup, press the [▶] (Play) button to start recording.

Press the [▶] (Play) button so that its indicator flashes, then actually start recording after the count-in.

**9** When you reach the end of the above notation, press the [■] (Stop) button to stop recording.

If you’ve played any wrong notes, press the [■] (Stop) button, then try recording again.

## Correcting wrong notes

If you’ve played any wrong notes while recording and wish to correct them, press the [EDIT] button from the Song Play mode to go to the Song Edit mode. Song Edit lets you clean up and edit data of already recorded Songs or insert new data to the Songs.

Check for any mistakenly recorded or wrong events on the Event List display of the Song Edit mode, then correct them as needed.

**1** Select the recorded Song then press the [EDIT] button to enter the Song Edit mode.

The Event List display appears.

**2** Select the track to be edited.

Press the Number button [1]. The list of the MIDI events recorded in the previous section appears on the display.

**NOTE** Various MIDI events as well as note on/off data are shown on the display if you operate controllers such as Pitch Bend wheel, knobs and sliders while recording.

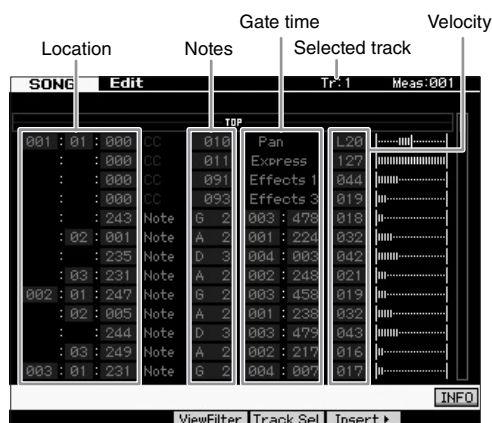

**3** Use the Cursor buttons to move the cursor to the location to be edited.

After confirming the location at which the wrong data is recorded, use the Up/Down Cursor button to move the cursor to the location, then use the Left/Right Cursor button to move the cursor to the data type to be corrected. For example, if you recorded a wrong note data at the 2nd note of the 3rd beat, move the cursor to the location indicated MEAS (measure) = 002, BEAT = 03 and CLOCK = 240. Then, move the cursor to NOTE if you wish to correct the note data and move the cursor to GATE if you wish to correct the gate time (note length).

**NOTE** Each key has a note name; for example, the lowest (farthest left) key on the keyboard corresponds to C1 and the highest (farthest right) key to C6. See page 10.

**NOTE** The Song location at which you edit or input the event is indicated by MEAS (measure), BEAT and CLOCK. A quarter-note (one beat when the time signature is set to “4/4”) consists of 480 divisions. The length of each note (gate time) is indicated by Beat and Clock. For example, 001:000 is equivalent to a quarter note and 000:240 is equivalent to an 8th note.



**4 Turn the data dial to edit the value.**

The entire line of the edited event will start flashing. You can also set the note directly from the keyboard, by holding down the [SF6] KBD button and pressing the desired note.

**5 Press the [ENTER] button to actually enter the edited data (the entire line of the edited event will stop flashing).**

Repeat steps 3 and 5 to correct other wrong events.

**6 After completing editing, press the [EXIT] button to return back to the Song Play mode.**

**NOTE** To easily delete an unnecessary note, move the cursor to the corresponding location, then press the [F6] button.

## Creating a swing feel—Play Effect

The Play Effect feature lets you alter the rhythm in a variety of musically useful ways—for example, to take something that was recorded ‘straight’ and give it a swing feel. Let’s change the performance you recorded above, and apply a swing feel to it here.

**1 From the Song Play display, press the [F2] button to call up the Play FX display.**

Quantize Value of Track 1      Swing Rate of Track 1

SCNG		Play									
Play Effect											
		Quantize		Swing		Note		Clock		Velocity	
Tr	Val	Str	Vel	Gate	Rate	Shift	Shift	Time	Rate	Offset	
1	off	100%	100%	100%	66%	+0	+0	100%	100%	+0	
2	off	100%				+0	+0	100%	100%	+0	
3	off	100%				+0	+0	100%	100%	+0	
4	off	100%				+0	+0	100%	100%	+0	
5	off	100%				+0	+0	100%	100%	+0	
6	off	100%				+0	+0	100%	100%	+0	
7	off	100%				+0	+0	100%	100%	+0	
8	off	100%				+0	+0	100%	100%	+0	
9	off	100%				+0	+0	100%	100%	+0	
10	off	100%				+0	+0	100%	100%	+0	
11	off	100%				+0	+0	100%	100%	+0	
12	off	100%				+0	+0	100%	100%	+0	
13	off	100%				+0	+0	100%	100%	+0	
14	off	100%				+0	+0	100%	100%	+0	
15	off	100%				+0	+0	100%	100%	+0	
16	off	100%				+0	+0	100%	100%	+0	

**2 Move the cursor to the Quantize Value of Track 1, then select the 8th note icon.**

**3 Move the cursor to the Swing Rate of Track 1, then select “66%.”**

This parameter determines the strength or amount of swing applied. Selecting “66%” delays each of the up beat notes to triplet values.

**NOTE** If you’ve recorded an accompanying part to track 2, make sure to apply the same settings to this track as well.

After completing the settings, press the [◀] (Top) button, then press the [▶] (Play) button to start the Song and listen to the swing feel in the playback.

### Applying the Play Effect setting to the actual MIDI data

The Play Effect setting temporarily changes how the Song data is played back, but does not actually change the Song MIDI itself. If you want to save the Play Effect changes as part of the Song data (for example, as a Standard MIDI file), you can use the Job operation to permanently apply the Play Effect settings.

To execute this Job:

- 1 Press the [JOB] button then [F5] Track button.
- 2 Move the cursor to “05: Normalize Play Effect” then press the [ENTER] button.
- 3 Select the corresponding Track, then press the [ENTER] button.

## Storing the created Song

After recording, make sure to store the created Song to internal memory by pressing the [STORE] button to call up the Song Store window.

The operation is basically the same as in the Voice Play mode

**NOTICE**

When you execute the Store operation, the settings for the destination memory will be overwritten. Important data should always be backed up to a separate storage device.

For more information about the Song, refer to the Song mode chapter in the Reference Manual.



# Creating an original Pattern

The Patterns of the MOTIF XF feature short but fully realized instrumental parts that you can repeat (loop), combine, and arrange in any order you want—giving you the basic material for creating a Song. This section covers what you can do in the Pattern mode.

## Pattern Structure

The MOTIF XF provides two modes for creating a Song: Song mode and Pattern mode.

In the Song mode, you can record the Song from the beginning to the end by playing the keyboard. In the Pattern mode, on the other hand, you can create the accompaniment of the Song by creating several sections, such as intro, melody A, main theme and ending, by recording your rhythm pattern to the different Sections, then combining them as a Pattern Chain.

The Pattern mode also lets you record your rhythm patterns or riffs to the different Sections as you wish—and as the inspiration hits—then combine the Sections into a Pattern Chain to create a complete Song. Along with the Arpeggio feature and Performance recording, you have a wide range of easy-to-use tools to quickly create fully arranged, professional sounding Songs.

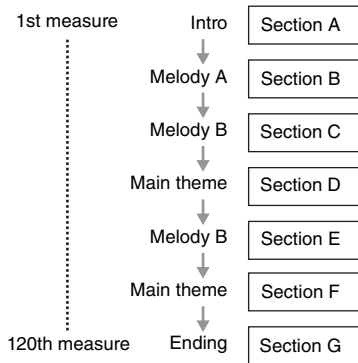

**NOTE** You can create a Pattern Chain by programming the order of Sections. The created Pattern Chain can be converted to Song data by using the Pattern Chain Edit. For details, refer to page 43.

## Listening to the Demo Patterns

Before creating your own original pattern, you should give a listen to some of the preset Demo Patterns. These specially recorded Patterns cover a wide range of musical genres and are full of great hints and ideas on how you can create and use Patterns in your own music.

**1** If necessary, load the Demo Patterns following the procedure on page 17.

**2** Press the [PATTERN] button to enter the Pattern mode.

The Pattern Play display will appear.

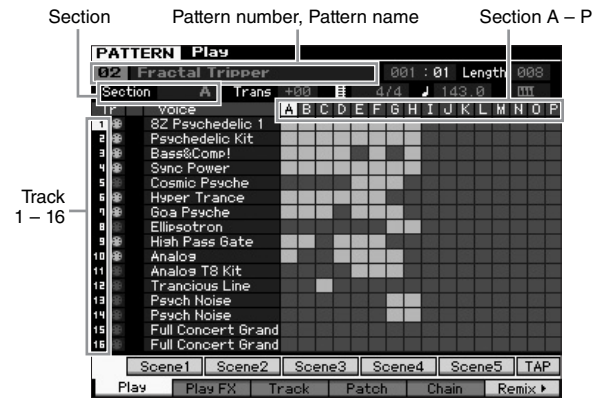

**NOTE** As indicated in the Pattern Play display, a Pattern consists of 16 separate tracks. Accordingly, a Pattern is played back via the various instrument Voices, such as bass, guitar and piano.

**3** Select a Pattern by turning the data dial.

**4** Press the [▶] (Play) button to start playback of the Pattern.

The Pattern will be played back repeatedly until you press the [■] (Stop) button.

**5** Change the Section from A – P.

Pressing the [A] – [H] buttons calls up Sections A – H and pressing the [USER 1] – [USER DR] buttons calls up the Sections I – P.

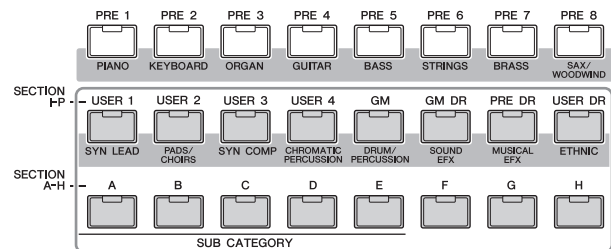

**NOTE** By changing the Sections, you can create rhythmic variations, and easily improvise arrangements (such as intro, verse, chorus, verse, chorus, ending) in real time.

**NOTE** When setting the Track Mute, Track Solo and the volume for each Part of the Pattern, use the same operation as the one in the Song mode. Refer to page 37.

Now, try other Patterns.

## Viewing the Demo Pattern's Patch display

From the Patch display called up via the [F4] button, you can confirm what "Phrase" is assigned to each track of the Pattern Section.

A "Phrase" is a short musical/rhythmic passage consisting of a single track for a single instrument, such as drum, bass, and guitar. This MIDI sequence data can be used as small building blocks for a Song, and can be assigned to any track and any Section. A single Pattern provides memory space for 256 of your own original User Phrases.

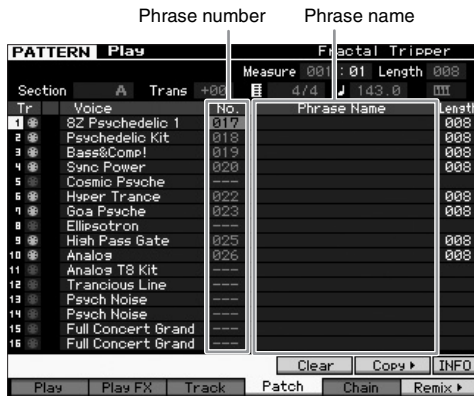

As indicated in this display, the performance data is recorded to the Phrase, then the Phrase is assigned to the recording track. Note that the created Phrase can be assigned to a different track of the same/different Section.

### Section A

Track 1	Phrase 001
Track 2	Phrase 002
:	:
Track 16	Phrase 003

Phrase 001	MIDI data
Phrase 002	MIDI data
Phrase 003	MIDI data
Phrase 004	MIDI data
:	:

### Section B

Track 1	Phrase 002
Track 2	Phrase 003
:	:
Track 16	Phrase 004

Try changing the Phrase for each track and assign each Phrase to an empty track.

**NOTE** Please keep in mind that Phrases are provided only for the Demo Patterns and the number of provided Phrases differs depending on the Demo Pattern. When you want to use a Phrase assigned to a different Pattern, execute the Copy Phrase function by using the [SF5] Copy button. For details, refer to the Reference Manual.

## Creating a Pattern by using Arpeggio

In addition to creating a Pattern by recording your keyboard performance conventionally, you can also use the powerful Arpeggio playback features of the MOTIF XF (described below) and even record audio data from commercially available sample CDs.

This section explains how to create a Pattern by using Arpeggio.

- 1 Press the [PATTERN] button to enter the Pattern Play mode.
- 2 Press the [●] (Record) button to call up the Record Setup display.
- 3 Press the [F1] button to call up the Record Setup display.

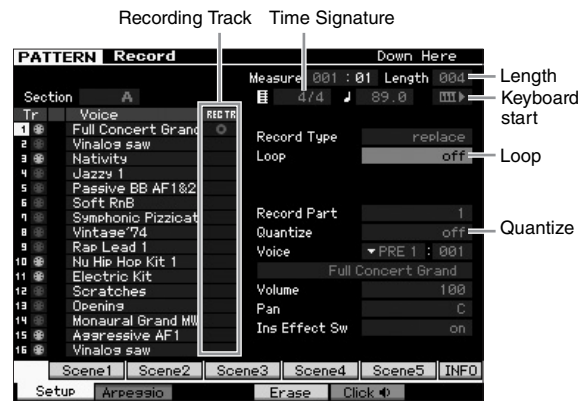

- 4 Set the following parameters in the Record Setup display.
  - 4-1 To select the desired track, press the [TRACK] button (the lamp lights), then press the appropriate Number button [1] – [16].
  - 4-2 Set the Time Signature as desired.
  - 4-3 Set the Pattern length to a value equivalent to the Arpeggio length.
  - 4-4 Turn the Keyboard Start icon " (on)."
  - 4-5 Set the Loop parameter to "off."
  - 4-6 Set the Quantize parameter to "off."
- 5 Press the [F2] button to call up the Record Arpeggio display.



**6 Set the following parameters as required in the Arpeggio Record display.**

- 6-1** Set the Switch parameter to on.
- 6-2** Set the Voice with Arpeggio (ARP) parameter to on. When this is set to "on," a Voice matching the selected Arpeggio type is automatically called up each time the Arpeggio type is changed.
- 6-3** Select the Arpeggio type by specifying the Category, Sub Category and Type.

**7 After completing setup, press a note on the keyboard to start recording.**

Recording will stop automatically when the last measure (specified by the Length) is reached.

**8 Press the [STORE] button to store the Pattern.**

### Storing the created Pattern

After recording, make sure to store the created Pattern to internal memory by pressing the [STORE] button to call up the Pattern Store window.

The operation is basically the same as in the Voice Play mode.

**NOTICE**

When you execute the Store operation, the settings for the destination memory will be overwritten. Important data should always be backed up to a separate storage device.

## Creating a Pattern Chain for converting to a Song

In these instructions you'll learn how to assign each of the created Pattern Phrases to the Section, arrange the Sections in your favorite order to create the Pattern Chain, and convert the Pattern Chain to a Song. This converted Song data can be used as backing accompaniment for Melody recording.

### Creating a Pattern Chain

This section explains how to create a Pattern Chain by arranging the Sections in order as shown in the example below.

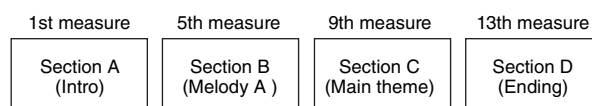

- 1 In the Pattern Play mode, select the desired Pattern.**
- 2 Press the [F5] Chain button.**
- 3 If necessary, move the cursor to the Tempo value then set the desired value.**

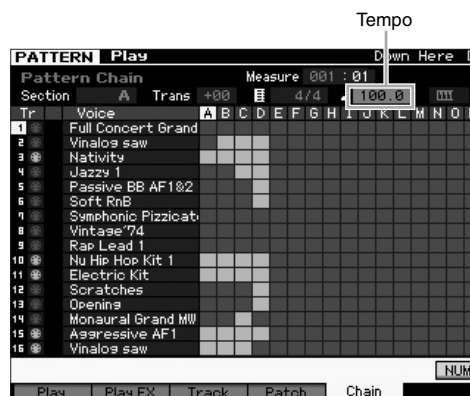

- 4 Press the [EDIT] button to enter the Pattern Chain Edit mode.**



- 5** Press the [SF4] Insert button to call up the Insert Event window and assign Section A to the 1st beat of the 1st measure.

After making sure that the Event Type is set to "Section," MEAS is set to "001," BEAT is set to "01," and CLOCK is set to "000," move the cursor to the corresponding location, select "A" by using the data dial, then press the [SF6] Set button to return to the Chain Edit display, from which you can confirm that the Section A has been assigned to the top of the Pattern Chain.

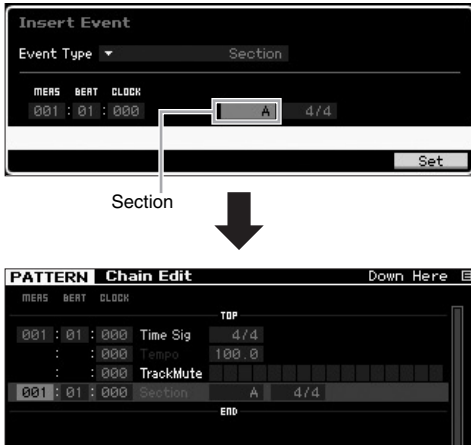

- 6** Using the same procedure as step 5, assign the Section B to the 1st beat of the 5th measure.

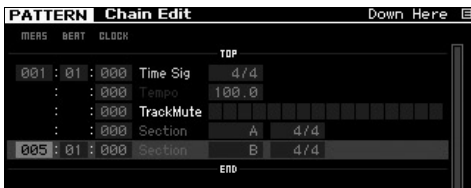

- 7** Using the same procedure as step 5, assign the Section C to the 1st beat of the 9th measure.

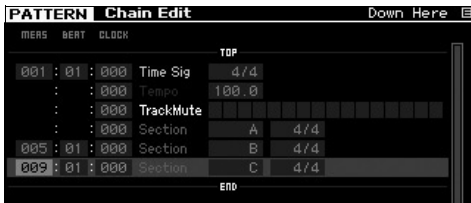

- 8** Using the same procedure as step 5, assign the Section D to the 1st beat of the 13th measure.

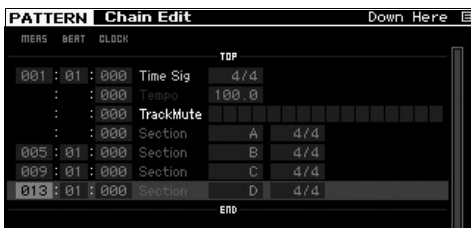

- 9** Assign the "end" indicator to the 14th measure.



**How to correct mistakes in the setting**

- **When setting the wrong Section**  
Move the cursor to the corresponding location, then select the correct Section.
- **When setting the wrong measure**  
Move the cursor to the corresponding line, move the cursor to MEAS, then change the measure number to the correct one.

- 10** Press the [EXIT] button to go back to the Pattern Play mode, then press the [▶] (Play) button to hear the chained playback of the Pattern Sections.

- 11** If necessary, press the [STORE] button to store the Pattern Chain as the current Pattern.

## Converting a Pattern Chain to a Song

Continuing the instructions from above, this next section explains how to convert the created Pattern Chain to Song data. This operation is necessary because Pattern Chain data does not include note events but only information about Section changes, meaning that you cannot add a melody part to this accompaniment.

**12** Press [PATTERN], [F5] Chain, then [EDIT] to enter the Pattern Chain Edit mode.

**13** Press the [SF3] Song button to call up the “Convert to Song” window, then select a Song having no data as the destination.

Here for example, set the Song to “04” and set the Measure to “001.” Enter a checkmark to the box of “Without Program Change.”

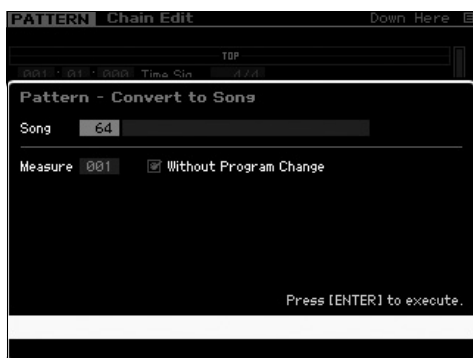

**14** Press the [ENTER] button to execute the Convert operation.

**15** Press the [SONG] button, select Song 04, then press the [▶] (Play) button to hear the converted Song data.

## Recording Melodies

Finally, record the melody part with the backing parts converted from the Pattern Chain.

**16** In the Song Play mode, turn on the [TRACK SELECT] lamp, then select a track having no data by using the Number [1] – [16] buttons.

You can confirm which track has no data by viewing the [F1] Track View display.



**17** Press the [●] (Record) button to enter the Song Record Standby mode.

**18** Set the Record Type to “replace.”



**19** Press the [▶] (Play) button to start recording.

To record, wait for one measure of the Count In, then begin playing.

**20** Press the [■] button to stop recording.

**21** Press the [◀] button to go back to the top of the Song, then press the [▶] (Play) button to hear the recorded Song.

**22** Press the [STORE] button to store the Song.

### NOTICE

The Song data will be lost when turning the power off. Make sure to execute the Store operation before turning the power off.

For more information about Patterns, refer to the Pattern mode chapter in the Reference Manual.

# Multi-timbral Tone Generator Settings for Song/Pattern Playback (Mixing mode)

A Mixing refers to the multi-timbral tone generator settings for the Song/Pattern playback. A Mixing consists of 16 Parts, which correspond to the tracks, and in the Mixing display you can adjust the various mixing related parameters for each Part. From the Song Play or Pattern Play display, press the [MIXING] button to call up the Mixing display, letting you confirm the Mixing settings for each Part: Voice, volume, pan, etc.

Now, let's try adjusting some of the Mixing parameters in the Mixing display.



## 1 From the Song Play or Pattern Play display, press the [MIXING] button to enter the Mixing mode.

The Mixing display will appear.

## 2 To select the desired Part, press the appropriate Number button [1] – [16].

**NOTE** Pressing the [F2] Audio button calls up the display which lets you set the parameters of the AD Part handling the audio signal input via the A/D Input jack and FW Part handling the audio signal input via the IEEE1394 terminal (available only when the optional FW16E has been installed).

## 3 Move the cursor to the Bank and Number, then change the Voice by specifying the Bank and Number.

If you press the [PROGRAM] button (the lamp lights), you can select the desired Voice by using the appropriate Bank, Group and Number buttons.

## 4 Move the cursor to the desired parameter, such as pan or volume, then rotate the data dial to change the value.

**NOTE** If you wish to edit more detailed Mixing parameters, enter the Mixing Edit mode by pressing the [EDIT] button. For more information about the Mixing Edit mode, refer to the Reference Manual.

## 5 To store the Mixing parameter settings, press the [STORE] button to store the Song or Pattern.

The Mixing parameter settings are included in the Song or Pattern data.

For details about the Mixing parameters, refer to the Mixing mode chapter in the Reference Manual.

# Using the Sampling feature

The MOTIF XF has a powerful Sampling function that lets you record audio signals—such as vocals from a microphone or electric guitar—and integrate the resulting Samples with the Voices and Performances of the instrument.

The Sampling mode lets you record sounds—such as vocals from a connected microphone, the signal from an electric guitar, or audio from an external CD or MP3 player—directly to the instrument, and store them as Samples.

1. Using as a User Voice in the Voice/Performance mode
2. Using as a Phrase or rhythm pattern of an audio track in the Song/Pattern mode

## NOTICE

The recorded (edited) sample data is lost when the power is turned off. Make sure to prepare a USB storage device before using the Sampling function.

### Flash Memory Expansion Module (sold separately)

The sample obtained via the Sampling function can be stored as a Waveform by installing the optional Flash Memory Expansion Module FL512M/FL1024M to the MOTIF XF. The sample on the Flash Memory Expansion Module will be maintained even if the power is turned off and can immediately be called up as a Waveform. This is convenient when using a User Voice containing a Waveform to which the Sample created via the Sampling function has been assigned.

## Setting up for Sampling

- 1 Turn the power off and make sure that the GAIN knob on the rear panel is set to the minimum position.

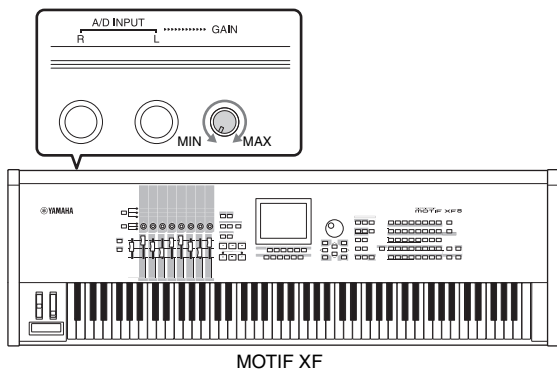

- 2 Connect the audio equipment or the microphone to the A/D INPUT jack on the rear panel.

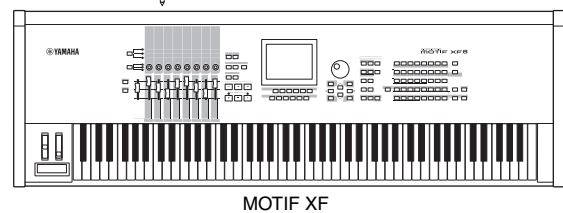
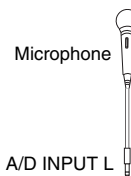
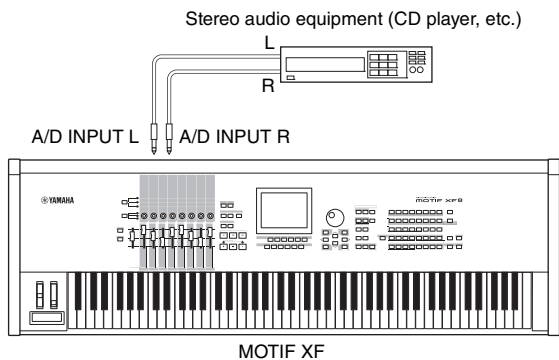

- 3 Turn the power of the MOTIF XF on.
- 4 Press the [UTILITY] button to enter the Utility mode then press the [F2] button to call up the I/O display.
- 5 Set the Mic/Line parameter to “line” or “mic.”  
Select “line” when the audio equipment is connected.  
Select “mic” when the microphone is connected.
- 6 Press the [STORE] button to store the setting.

Sampling setup is completed.

## Sampling in the Voice/ Performance mode

When you enter the Sampling mode from the Voice mode or Performance mode, you can create your own original Samples, edit them, assign them to a Waveform, and then assign the original Waveform to a User Voice. Also, in the Performance mode, the User Voice can be assigned to a Part of a Performance.

### Sampling procedure

- 1 Connect a microphone or other audio equipment to the MOTIF XF.**  
For information about how to do this, see page 16.
- 2 Enter the Voice mode or Performance mode.**  
When entering the Performance mode, select a Performance to which the Sample will be assigned.
- 3 Press the [INTEGRATED SAMPLING] button to enter the Sampling mode. (The indicator lights.)**  
The Sampling Main display appears.
- 4 Press the [F6] Rec button to call up the Record Setup display, then set each parameter as follows.**



Recording Type	Select "sample."
Input Source	Select "A/D Input."
Mono/Stereo	Select "stereo."
Record Next	Select "off."
Frequency	Select "44.1kHz."
Waveform	Select a Waveform having no name (shown as the broken line in the name box below the Waveform number). As name, "New Waveform ***" is assigned to the selected Waveform when stored.
Keybank	Select the note to which you want to assign the sample obtained via the Sampling function.
Voice	Select the Voice Bank and Number as sample destination.
Part	Select the Performance Part to which the new Voice is assigned. This parameter is available only when entering the Sampling mode from the Voice mode.

Set other parameters as necessary.

- 5 Press the [F6] Standby button to call up the Record Standby display.**
- 6 Set the following parameters on the Standby display.**
  - 6-1 Set the Trigger Mode to "level."**



- 6-2 Set the Trigger Level so that the red triangle of the level meter (indicating the Trigger Level) is slightly below the level at which the sound is input.**

**NOTE** The Trigger Mode parameter lets you determine how the Sampling actually starts. When Trigger Mode is set to "level," sampling will begin automatically as soon as the input signal exceeds the specified Trigger Level. When using a microphone, you should set the Trigger Level a little higher than expected, since noise preceding the signal may trigger the Sampling operation sooner than intended.

- 7 Adjust the input sound level for optimum level by using the GAIN knob on the rear panel.**

Try to set the input level as high as possible without clipping for the best sound quality. If you cannot adjust the input level appropriately, change the Mic/Line setting in the Utility mode.

- 8 Turn the Confirm function on or off by pressing the [SF1] button.**

This determines whether you can confirm the recorded Sample (on) or not (off) after Sampling is finished. When Confirm is turned on, you can easily listen back to your just-recorded Sample and conveniently re-record it if you are not satisfied with the results. When Confirm is turned off, the Sampling operation will automatically fix the Sample data and return to the Setup display. Please note that the instrument returns to the STANDBY display after Sampling is finished when Record Next is turned on in the Setup display.

- 9 Press the [F5] Start button.**

This operation enables Sampling but does not start it (a WAITING indication appears in the display).

- 10 Play the sound to be sampled.**

When an audio signal exceeding the specified Trigger Level is input to the instrument, the RECORDING indication replaces the WAITING indication and Sampling starts. During Sampling, a graphic representation of the recorded audio appears in the display.



## 11 Press the [F6] Stop button to stop Sampling.

- If you set Confirm to on in step 8 above, the Sampling Finished display appears. Press the [SF1] Audition button to hear the sampled sound. If you are satisfied with the results, press the [ENTER] button to store the sampled sound as a "Sample" and return to the Setup display. If you are not satisfied with the results and you wish to try again, press the [EXIT] button to return to the Standby display and try Sampling from step 5 again.
- If you set Confirm to off in step 8 above, the sampled sound will be stored as a "Sample" automatically.

## 12 Save the Waveform.

If the optional Flash Memory Expansion Memory (FL512M/FL1024M) is installed to the MOTIF XF, use the Copy Job (page 53) to save the Waveform. If not, save the Waveform to the USB storage device (page 64).

### NOTICE

The recorded (edited) Sample data will be lost when turning the power off. Before turning off the power, you should always copy the Sample data to the optional Flash Memory Expansion Memory (page 53), or save the Sample data to a USB storage device (page 64).

## Sampling Edit procedure

### 1 Press the [INTEGRATED SAMPLING] button to enter the Sampling mode. (The indicator lights.)

The Sampling Main display appears.

### 2 Select a Waveform and Key Bank to which the Sample to be edited is assigned.

### 3 Press the [EDIT] button to enter the Sampling Edit mode.

### 4 Press the [F1] Trim button, then set the desired parameter.

From this display, you can set various parameters.

Here, delete the unnecessary parts of the Sample. Setting the Start Point and End Point determines the necessary part of the Sample. You can confirm the setting result by pressing the [SF1] Audition button. If you are satisfied with the result, press the [ENTER] button to actually extract the unnecessary parts of the Sample data.

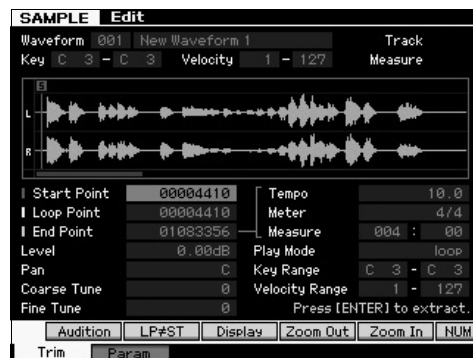

Next, set the Key Range within which you can play the Sample sound. Set the Key Range to "C2 – B3," for example. You can confirm the setting result by actually playing the keyboard. The Sample sounds at a pitch suitable for each note.



### 5 Save the Waveform.

If the optional Flash Memory Expansion Memory is installed to the MOTIF XF, use the Copy Job (page 53) to save the Waveform. If not, save the Waveform to a USB storage device (page 64).

## Sampling in the Pattern mode

In addition to its use in the Voice and Performance modes, the Sampling mode can also be entered from the Song and Pattern modes. This lets you record audio (such as vocals, electric guitar, or audio from an external device), and use it directly on a Song/Pattern track as a Sample Voice.

In this section, you'll learn how to record audio data (from commercially available sample CDs, for example) to the Pattern track, using the versatile Sampling feature. After recording the audio, you can slice it into individual Samples, which can then be played back at any desired tempo—without compromising the sound or introducing pitch changes. These step-by-step instructions assume that the recorded audio data is a one-measure drum pattern in 4/4 time.

### Sampling procedure

- 1 Connect the audio equipment (CD player) to the MOTIF XF.**  
For information about how to do this, see page 47.
- 2 Press the [PATTERN] button to enter the Pattern mode, then select the Pattern Number and Section.**
- 3 Press the [INTEGRATED SAMPLING] button to enter the Sampling mode. (The indicator lights.)**  
The Sampling Main display appears.
- 4 Press the [F6] Rec button to call up the Record Setup display, then set each parameter as follows.**



Recording Type	Select "slice+seq."
Input Source	Select "A/D Input."
Mono/Stereo	Select "stereo."
Record Next	Select "off."
Frequency	Select "44.1kHz."
Track	Select the track to which the Sample Voice is assigned.

Set other parameters as necessary.

- 5 Press the [F6] Standby button to call up the Record Standby display.**
- 6 Set the Trigger Mode to "level," and set the Trigger Level to "1."**

- 7 Play back the audio source (CD player) and adjust the audio input level with the GAIN knob on the rear panel to set the appropriate level.**

Adjust the GAIN so that the level is high enough for a clean recording but not so high as to cause clipping or distortion.

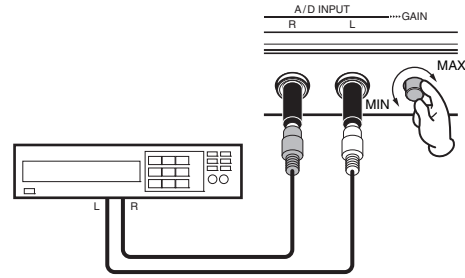

**NOTE** Please note that the input sound may be clipped or distorted if the meter reaches maximum level.

- 8 Stop playback of the audio source (CD player).**
- 9 Press the [F5] button to call up the WAITING indicator (Trigger Standby status).**
- 10 Start the CD player.**  
Since the Trigger Level is set to "1" here, sampling will begin automatically as soon as the audio signal is input from the CD player. In this example, record a one-measure drum pattern from the CD.
- 11 Press the [F6] button to stop sampling, then stop the CD player.**  
The wave of the recorded audio signal will be shown on the display.
- 12 Press the [SF1] button to hear your newly recorded sound.**

### Sampling Edit procedure

#### ■ Setting the End Point of the Recorded Sample

The start point of the recorded Sample will probably be at the correct place—the first beat of the measure—since Sampling start was set to begin automatically with the Trigger Level setting. However, the end point may not be at the end of the measure as desired, since Sampling was stopped manually. Accordingly, you may need to edit the End Point of the recorded sample so that playback of the recorded sample properly matches the beat timing.

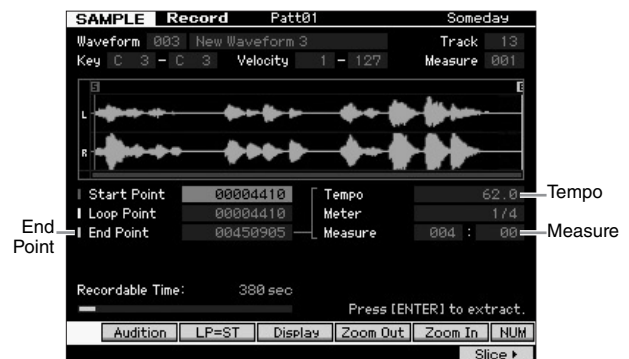

**13** Press the [SF2] button once or twice so that the LP=ST indication is shown.

**14** Move the cursor to the End Point then adjust the value by using the data dial.

Press the [SF1] button to hear the sample. Adjust the End Point so that the Sample plays back smoothly and continuously without stutters, glitches or problems in timing.

**15** After setting the Ending Point, press the [ENTER] button to delete unnecessary data (located after the End point).

After the display prompts you for confirmation, then press the [INC/YES] button to execute the Extract operation.

**NOTE** Many commercially available sample/loop CDs include information on the tempo, measure and meter of specific loops. If this information is available, enter the appropriate values to the parameters above.

#### ■ NOTICE ■

The data deleted via the Extract operation cannot be recovered. If you have accidentally deleted a necessary portion of the Sample, press the [EXIT] button to return to the Setup display, then execute the Sampling operation again.

#### ■ Slice

Next, let's use the Slice function to match the recorded sample with the tempo. This Slice feature lets you automatically divide the recorded sample into separate "slices." These slices are then assigned to successive notes and arranged as MIDI data. This lets you manipulate the component parts of your sample loops as MIDI data, and gives you the power to easily change tempo and even the rhythmic feel, without disturbing the pitch or sound quality.

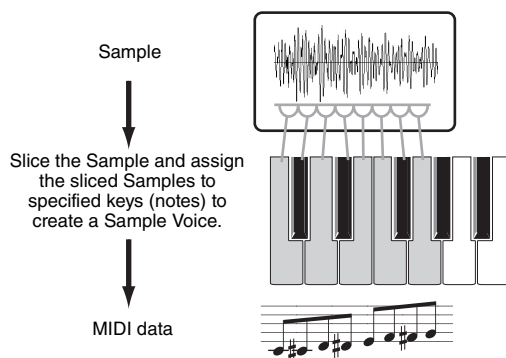

**NOTE** Before executing the Slice operation, you'll need to accurately adjust the length of the sample by adjusting the End Point.

**16** Press the [F6] button to call up the Slice display, then set each parameter as follows.

Since the recorded sample is a one-measure drum pattern in 4/4 time, set the parameters below as shown.

Type	Select "beat1."
Measure	Select "1."
Sensitivity	Select "4."

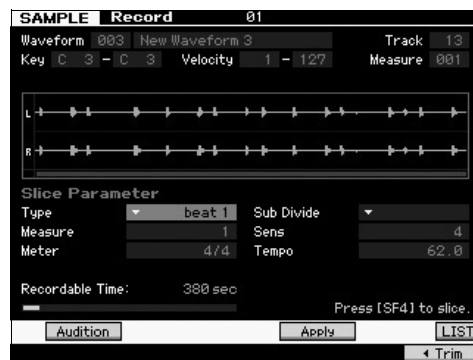

**17** Press the [SF4] Apply button to execute the Slice operation.

**18** Press the keys to which the sliced sample are assigned in order (from C1 for the MOTIF XF6, E0 for the MOTIF XF7, and A-1 for the MOTIF XF8) to confirm whether or not the Sample has been sliced properly.

Listen carefully to the results. If you're not satisfied, press the [SF4] Cancel button again to abort the Slice operation and return the sample to the original status, then try the operation again. Repeat steps 2 – 4 by trying another Slice Type and adjusting the value of the Sensitivity until you are satisfied with the sound.

**19** Press the [ENTER] button to fix the Slice result as Sample data.

**20** Press the [PATTERN] button to call up the Pattern Play display then press the [▶] (Play) button to hear the sliced Sample.

You can change the tempo of the sliced rhythm pattern. Try changing the tempo in the Pattern Play mode.



**21** Press the [STORE] button to store the Pattern.

**22** Save the Waveform.

If the optional Flash Memory Expansion Memory is installed to the MOTIF XF, use the Copy Job (page 53) to save the Waveform. If not, save the Waveform to a USB storage device (page 64).

**NOTE** After creating several Patterns (Sections), use the Pattern Chain feature (page 43) to string them together.

## Sampling a one-shot sound in the Song mode

The MOTIF XF conveniently lets you sample audio material, even while a Song is playing. This allows you to quickly and easily “fly in” samples to your Song as you need them — for example, capturing short sound effects from a CD, or recording background vocal phrases with a microphone. Sounds like these can be added to the Song as desired.

- 1 Connect the audio equipment to the MOTIF XF.**  
For information about how to do this, see page 47.
- 2 Press the [SONG] button to enter the Song mode, then select the Song Number.**
- 3 Press the [INTEGRATED SAMPLING] button to enter the Sampling mode. (The indicator lights.)**
- 4 Press the [F6] Rec button to call up the Record Setup display, then set each parameter as follows.**



Recording Type	Select “sample+note.”
Input Source	Select “A/D Input.”
Mono/Stereo	Select “stereo.”
Record Next	Select “off.”
Frequency	Select “44.1kHz.”
Track	Select the track to which the Sample Voice is assigned.
Keybank	Select the note to which you want to assign the sample obtained via the Sampling function.

Set other parameters as necessary.

- 5 Press the [F6] Standby button to call up the Record Standby display, then make the necessary settings.**



Trigger Mode	Select “measure.”
Punch In/Out	At Punch In, set the measure number at which the Sampling starts automatically during Song playback. At Punch Out, set the measure number at which the Sampling ends automatically during Song playback.

- 6 Press the [F6] REC button again to enable Punch In Waiting.**  
Doing this puts sample recording on standby, waiting for song playback to reach the specified Punch-in measure.
  - 7 Press the [▶] (Play) button to start Song playback.**
  - 8 Start the audio equipment when the Song reaches the Punch In point (when sampling actually starts).**  
Audio is recorded to the instrument.
  - 9 Stop the audio equipment when the Song reaches the Punch Out point (when sampling stops).**  
Press the [SF1] AUDITION button to hear the sampled sound.  
If you're not satisfied with the results and you wish to try again, press the [EXIT] button to return to the Sampling Standby display and try sampling from step 4 again.  
If you are satisfied with the results, press the [ENTER] button to store the sampled sound as a “sample” and return to the Sampling Record display.
  - 10 Press the [SONG] button or [EXIT] button to return to the Song Play mode.**
  - 11 Press the [▶] (Play) button to play the Song.**  
Listen back to the Song (the sample automatically sounds along with playback) and check that the timing is correct. If you're not satisfied with the timing, you can adjust it as needed in the Song Edit mode.
  - 12 Press the [STORE] button to store the Song.**
  - 13 Save the Waveform.**  
If the optional Flash Memory Expansion Memory Module is installed to the MOTIF XF, use the Copy Job (page 53) to save the Waveform. If not, save the Waveform to a USB storage device (page 64).
- **NOTICE** ■
- The recorded (edited) Sample data will be lost when turning the power off. Before turning off the power, you should always copy the Sample data to the optional Flash Memory Expansion Memory (page 53), or save the Sample data to a USB storage device (page 64).

## Saving a Waveform to the Flash Memory Expansion Module

This section covers how to save a Waveform (to which the Sample has been assigned via the Sampling function) to the optional Flash Memory Expansion Module (page 76).

- 1 In the Sampling mode, press the [JOB] button to enter the Sampling Job mode.
- 2 Press the [F3] Other button.

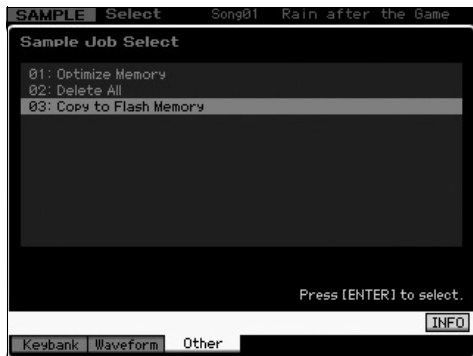

- 3 Select "03: Copy to Flash Memory" then press the [ENTER] button.

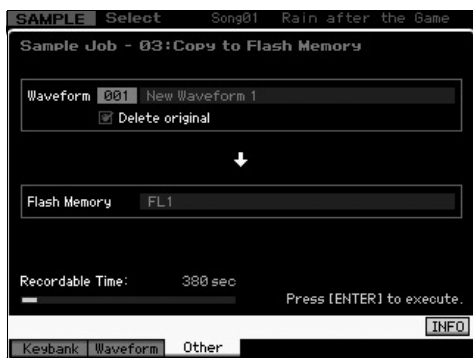

- 4 Select the Waveform including the Sample obtained via the Sampling function.
- 5 Select the Flash Memory Slot as the destination.
- 6 Press the [ENTER] button to execute the Copy operation.  
The Sample data included in the selected Waveform will be copied to the Flash Memory.  
**NOTE** When the selected Waveform includes no Sample data, "No Data" appears and the Copy operation will not be executed.
- 7 Press the [EXIT] button twice to return to the Sampling Main display.

For more information about the Sampling feature, refer to the Sampling mode chapter in the Reference Manual.

# Making Global System Settings (Utility mode)

In the Utility mode, you can set parameters that apply to the entire system of this instrument. To enter the Utility mode, press the [UTILITY] button. Pressing the [EXIT] button returns to the original display. This section describes some useful functions in the Utility mode.

## Setting automatic power-on tasks

You can specify certain automatic tasks that the MOTIF XF will perform when power is turned on.

- 1 Press the [UTILITY] button to enter the Utility mode, then press the [F1] then [SF4] button to call up the Auto Load Setup display.



- 2 Set the Auto Load to on or off.

When set to "on," the specified file on the USB storage device will be loaded automatically when the power is turned on. The file loaded automatically can be selected by pressing the [SF5] SELECT button and the name of the selected file will be shown on the display.

- 3 With the Power On Mode, select the Mode to be called up when the power is turned on.

### Settings:

performance	When turning the power on next time, the Performance Play mode is entered and the first program number (USR1: 001) is selected automatically.
voice (USER1)	When turning the power on next time, the Voice Play mode is entered and the first program number of User Voices (USR1: 001) is selected automatically.
voice (PRE1)	When turning the power on next time, the Voice Play mode is entered and the first program number of Preset Voices (PRE1: 001) is selected automatically.
voice (GM)	When turning the power on next time, the Voice Play mode is entered and the first program number of Preset GM Voices (GM: 001) is selected automatically.
master	When turning the power on next time, the Master Play mode is entered and the first program number (001) is selected automatically.

- 4 Press the [STORE] button to store this setting.

## Selecting the Design Type of the display

You can select the design type of the Top display in the Voice mode, Performance mode and Master mode.

- 1 Press the [UTILITY] button to enter the Utility mode, then press [F1] then [SF2] to call up the Screen Setting display.

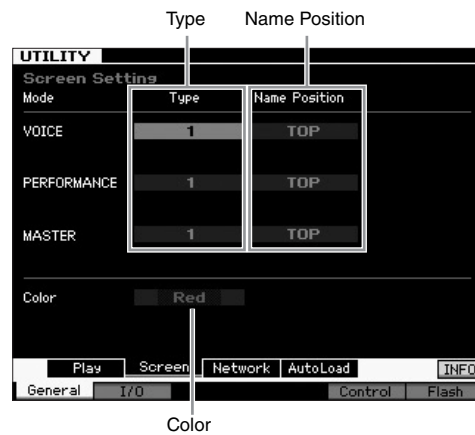

- 2 Move the cursor to the desired location then make the desired setting by referring to the following description.

Type	1	The Top display of each mode will indicate the current status of the Knob/Slider, etc.
	2	The Top display of each mode will indicate the on/off status of each Element/Part, status of the panel controllers and the status of the current Arpeggio, etc.
Name Position	Top	The number/name of the program (Voice, Performance or Master) is shown at the top of the display.
	Bottom	The number/name of the program (Voice, Performance or Master) is shown at the bottom of the display.
Color	One of the following color types can be selected commonly for the three modes: Red, Pink, Purple, Blue, Aqua, Green, Yellow, and White.	

- 3 Press the [STORE] button to store this setting.

### Changing the Design Type on the Top display for each mode

You can change the design type on the top display for each of the Voice, Performance and Master Play mode. Holding the [EXIT] button and pressing the Cursor [<] button will set the Type to "1" while holding the [EXIT] button and pressing the Cursor [>] button will set the Type to "2."

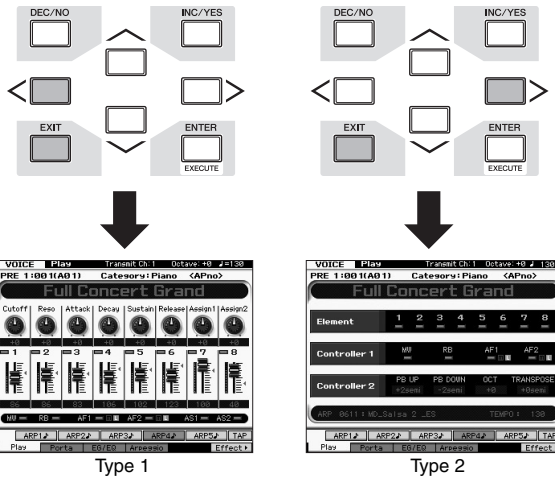

Holding the [EXIT] button and pressing the Cursor [^] button will set the Name Position to "Top" while holding the [EXIT] button and pressing the Cursor [v] button will set the Name Position to "Bottom."

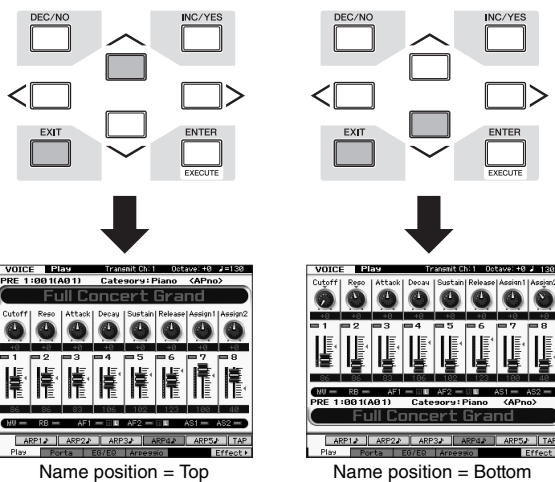

Press the [UTILITY] then [STORE] button to store the Utility setting before turning the power off, if you want to call up the same design type of the display when turning the power on next time.

## Adjusting the tuning

When you play the MOTIF XF with other instruments, you may need to tune the overall sound of the MOTIF XF to match that of the other instruments in the group.

- 1 Press the [UTILITY] button to enter the Utility mode, press the [F1] button, then press the [SF1] button to call up the Play display as below.

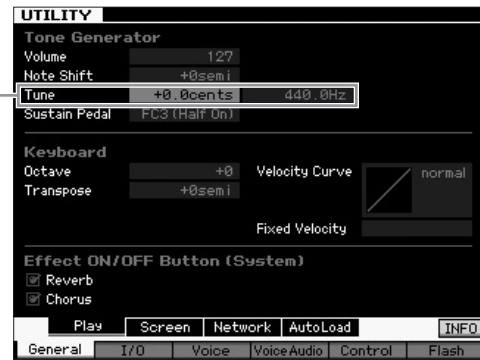

- 2 Move the cursor to Tune, then set the value.

In this example, we'll change the value from "440 Hz" to "442 Hz." Since the Tune parameter is actually adjusted in cents (1 cent = 1/100th of a semitone), the corresponding value in Hertz is shown at right. Since 1 Hz is roughly equivalent to 4 cents, set this value to "+8.0."

- 3 Press the [STORE] button to store the Utility setting.

## Transpose

This function allows the overall pitch of the MOTIF XF to be transposed up or down in semitone increments/decrements. You can play the same notes on the keyboard even when the pitch of the song is shifted up or down in semitones.

- 1 Press the [UTILITY] button to enter the Utility mode, press the [F1] button, then press the [SF1] button to call up the Play display as shown.

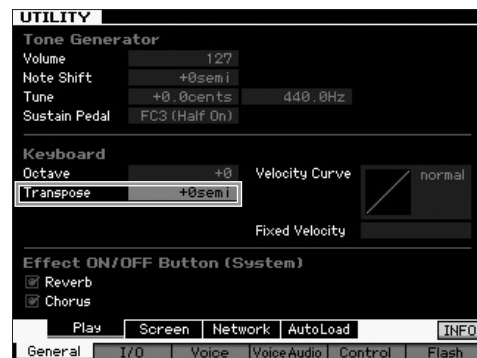

- 2 Move the cursor to Transpose, then set the value.

Set the value to "+1" to transpose the pitch up by a semitone, or set it to "-1" to transpose it down by a semitone. To transpose it up or down by a whole tone, set this to "+/-2"; to transpose by an octave, set it to "+/-12."

**NOTE** To transpose by octaves, use the Octave parameter (above Transpose).

- 3 Press the [STORE] button to store the Utility setting.

For more information, refer to the Utility mode chapter in the Reference Manual.

# Using a Connected Computer

By connecting the MOTIF XF to your computer via USB or IEEE1394, you can use a DAW or sequence software on the computer to create your own original songs. This section contains an overview on how to use a DAW or sequence software on the connected computer with the MOTIF XF.

**NOTE** The acronym DAW (digital audio workstation) refers to music software for recording, editing and mixing audio and MIDI data. The main DAW applications are Cubase, Logic, SONAR and Digital Performer. Though all of these can be effectively used with the MOTIF XF, for optimum ease of use we recommend using Cubase when creating songs together with the instrument.

By connecting this instrument to a computer, you can take advantage of the following functions and applications.

- External tone generator for DAW software and MIDI keyboard
- Remote Controller of the DAW software
- More detailed Voice Editing from the computer (MOTIF XF Editor VST)

## Using the USB TO HOST terminal

A USB cable and appropriate USB-MIDI Driver are necessary to connect the MOTIF XF to the computer. Follow the instructions below. Note that only MIDI data can be transmitted through a USB cable.

**NOTE** Since the MOTIF XF has no built-in speakers, you'll need an external audio system or a set of stereo headphones to properly monitor it. For details, refer to "Setting Up" on page 16.

### 1 Download the appropriate USB-MIDI Driver from our website.

After clicking the Download button, extract the compressed file.

[http://www.global.yamaha.com/download/usb\\_midi/](http://www.global.yamaha.com/download/usb_midi/)

**NOTE** Information on system requirements is also available at the above web site.

**NOTE** The USB-MIDI Driver may be revised and updated without prior notice. Make sure to check and download the latest version from the above site.

### 2 Install the USB-MIDI Driver to the computer.

For instructions on installing, refer to the online Installation Guide included in the downloaded file package. When connecting this instrument to a computer in the Installation procedure, connect the USB cable to the USB TO HOST of this instrument and the USB terminal of the computer as shown below.

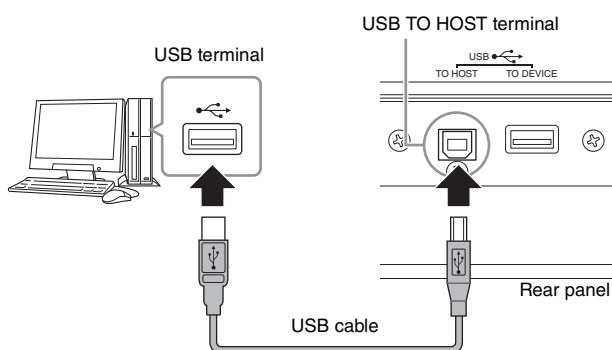

### 3 Make sure that the USB TO HOST terminal of this instrument is enabled.

Press the [UTILITY] button to enter the Utility mode, then press the [F5] button followed by the [SF2] button to call up the MIDI display. On this display, set the MIDI In/Out parameter to "USB."

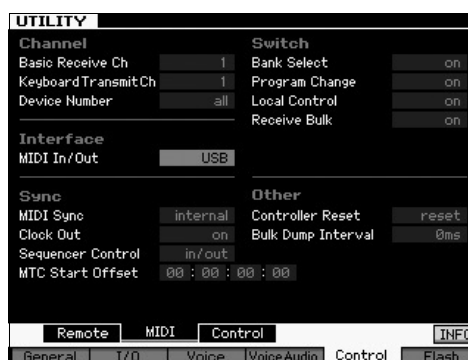

### 4 Press the [STORE] button to store the setting.

#### Notices when using the USB TO HOST terminal

You must observe the following points when connecting the MOTIF XF to your computer via the USB TO HOST connector. Failure to do so can cause the instrument and/or the computer to hang up (freeze), possibly causing corruption or loss of data. If the computer or MOTIF XF freezes, turn the power to the MOTIF XF off and then on, then restart the computer.

- Before connecting the computer to the USB TO HOST terminal, exit from any power-saving mode of the computer (such as suspended, sleep, standby).
- Before turning on the power to the instrument, connect the computer to the USB TO HOST connector.
- Execute the following before turning the power to the instrument on/off or plugging/unplugging the USB cable to/from the USB connector.
  - Quit any open applications (such as MOTIF XF Editor VST and sequencer software).
  - Make sure that data is not being transmitted from the instrument. (Data is transmitted only by playing notes on the keyboard or playing back a song.)
- Leave an interval of at least six seconds between powering the MOTIF XF on and off, or between disconnecting and connecting the USB cable.



### MIDI channels and MIDI ports

MIDI data is assigned to one of sixteen channels, and this synthesizer is capable of simultaneously playing sixteen separate Parts, via the sixteen MIDI channels. However, the sixteen-channel limit can be overcome by using separate MIDI “ports,” each supporting sixteen channels. While a single MIDI cable is equipped to handle data over up to sixteen channels simultaneously, a USB connection is capable of handling far more—thanks to the use of MIDI ports. When connecting this instrument to a computer using a USB cable, the MIDI ports are defined as follows:

#### Port 1

This port is used to control the DAW software on the computer from the MOTIF XF by using the Remote Control feature. When playing the MOTIF XF as a tone generator from the external MIDI instrument or computer, you should set the MIDI Port to 1 on the connected MIDI device or computer.

#### Port 2

This port is used to control the DAW software on the computer from the MOTIF XF by using the Remote Control feature.

#### Port 3

This port is used as the MIDI Thru Port. The MIDI data received over Port 3 via the USB TO HOST terminal will be re-transmitted to an external MIDI device via the MIDI OUT terminal. The MIDI data received over Port 3 via the MIDI IN terminal will be re-transmitted to an external device (computer, etc.) via the USB TO HOST terminal.

#### Port 4

This port is used only for data communication of the MOTIF XF Editor VST. No other software or device can use this port.

When using a USB connection, make sure to match the MIDI transmit port and the MIDI receive port as well as the MIDI transmit channel and the MIDI receive channel. Make sure to set the MIDI port of the external device connected to this instrument according to the above information.

## Using the MIDI terminal

Using an optional MIDI interface such as UX16 allows you to connect the MOTIF XF to the computer via a MIDI cable. Make the proper settings of the MIDI interface, then connect the MIDI cable to the MIDI terminal of the MOTIF XF and the MIDI interface.

**NOTE** For details about the settings, refer to the manual of the MIDI interface.

## Using the IEEE1394 terminal

When the optional FW16E (FireWire expansion board) is installed, the MOTIF XF can be connected to the computer via an IEEE1394 cable. Note that the audio data as well as MIDI data can be transmitted through an IEEE1394 cable by installing the Yamaha Steinberg FW Driver to the computer.

**NOTE** For instructions on installing the FW16E, see page 75.

**NOTE** The FW16E-equipped MOTIF XF can provide up to 6 Mono In (3 Stereo In), 16 Mono Out (8 Stereo Out) audio channels and 3 MIDI In/3 MIDI Out channels.

### 1 Download the Yamaha Steinberg FW Driver from our website:

<http://www.yamahasyth.com/>

**NOTE** Information on system requirements is also available at the above website. The Yamaha FW Driver may be revised and updated without prior notice. Make sure to check and download the latest version from the above site.

### 2 Install the Yamaha Steinberg FW Driver to the computer.

For instructions on installing, refer to the online Installation Guide included in the downloaded file package. When connecting the MOTIF XF to a computer in the Installation procedure, connect the IEEE1394 cable to the IEEE1394 connector of the MOTIF XF and the IEEE1394 connector of the computer as shown below.

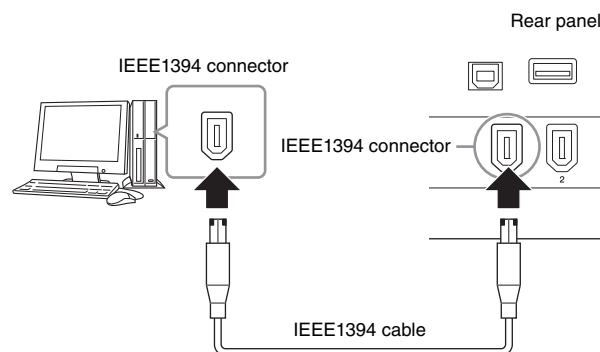

#### ■ NOTICE ■

Be sure to connect the IEEE1394 cable plug to the IEEE1394 connector with the correct orientation.

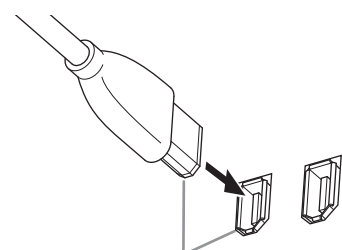

Plug in the jack with the correct orientation.

**NOTE** For optimum results, use an IEEE1394 cable shorter than 4.5 meters.

### 3 Make sure that the IEEE1394 connector of the MOTIF XF is enabled for MIDI communication.

Press the [UTILITY] button to enter the Utility mode, then press the [F5] button followed by the [SF2] button to call up the MIDI display. Set the MIDI In/Out parameter to "FW."

### 4 Make sure that the IEEE1394 connector of the MOTIF XF is enabled for audio communication.

When transmitting audio signals via the IEEE1394 connector, set the Output Select parameter of the MOTIF XF. When receiving audio signals via the IEEE1394 connector, set the FW audio input part parameters of the MOTIF XF. For details, see page 59.

### 5 Press the [STORE] button to store this setting.

## What you can do with the IEEE1394 connection

You can integrate the MOTIF XF with DAW software on a computer by connecting the FW16E-equipped MOTIF XF to a computer. For details, see below.

- Transfer data of multiple audio channels between the MOTIF XF and the computer (up to 16 channels from the MOTIF XF to the computer and up to 6 channels from the computer to the MOTIF XF)
- Simultaneously record to the sequence software (a) your performance on the MOTIF XF and (b) the performance of the computer sequence software that uses the MOTIF XF as a MIDI tone generator
- Monitor via the MOTIF XF the audio output from the computer and the audio output from the MOTIF XF
- Use Cubase together with the MOTIF XF and take advantage of a variety of convenient functions in that DAW program

For details and the latest information on what is possible through connection of the MOTIF XF and computer via an IEEE1394 cable, refer to the following URL:  
<http://www.yamahasyth.com/>

## Signal flow of audio and MIDI data via an IEEE1394 cable

The illustration below shows the flow of audio signals and MIDI messages when connecting the MOTIF XF and a computer via an IEEE1394 cable.

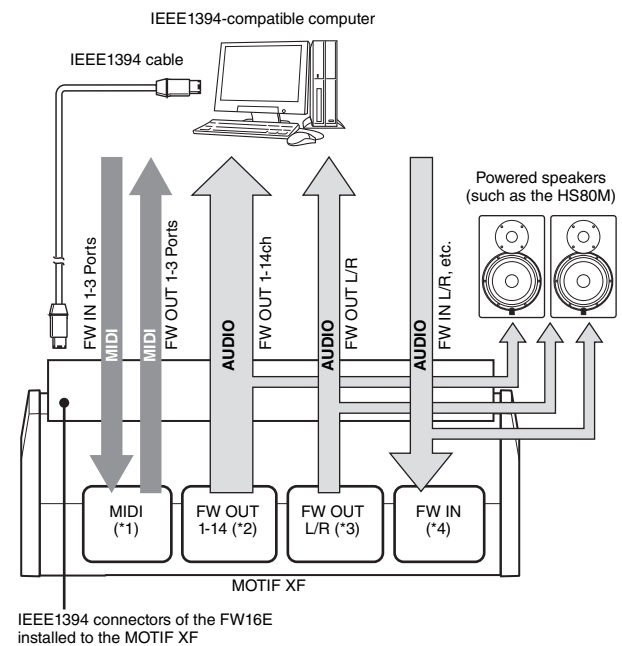

### MIDI transmission/reception (\*1)

Setting the port on the MOTIF XF is not necessary since the MIDI Port of the MOTIF XF is automatically fixed according to the application. For information on which port should be selected on your computer, refer to page 59.

### Audio signal transmission

#### ■ FW OUT 1 – 14 (\*2)

Audio signals are output via FW OUT 1 – 14 when the MOTIF XF Output Select parameter is set to any of the settings "FW1&2" – "FW13&14" and "FW1" – "FW14" in one of the following displays.

- [VOICE] (When a Drum Voice is selected) → [EDIT] → Key selection → [F1] Oscillator
- [VOICE] → [UTILITY] → [F4] VoiceAudio → [SF1] Output
- [PERFORM] → [EDIT] → [COMMON EDIT] → [F4] Audio In → [SF1] Output
- [PERFORM] → [EDIT] → Part selection → [F1] Voice → [SF2] Output
- [SONG]/[PATTERN] → [MIXING] → [EDIT] → [COMMON EDIT] → [F4] Audio In → [SF1] Output
- [SONG]/[PATTERN] → [MIXING] → [EDIT] → Part selection → [F1] Voice → [SF2] Output

#### ■ OUTPUT L/R (\*3)

The audio signal is output via both the OUTPUT L/R and FW OUT L/R channels when the Output Select parameter described above is set to "L&R."

## Audio signal reception (\*4)

In addition to the FW IN L/R inputs, the FW IN Main Out Monitor L/R and FW IN Assignable Out Monitor L/R are available as FW audio input channels on the MOTIF XF. These channels can be used for monitoring the sound when using the DAW software on the computer. The audio signal received via the FW IN Main Out Monitor L/R will be output via the OUTPUT L/R jacks while the audio signal received via the FW IN Assignable Out Monitor L/R will be output via the ASSIGNABLE OUTPUT L/R jacks.

Setting the audio output channel on the computer determines which channel is used. As for audio signals received via the IEEE1394 connector, parameters such as volume and output channel can be applied as the FW audio input part of the MOTIF XF. The display of these parameter settings differs depending on the mode, as listed below.

- [VOICE] → [UTILITY] → [F4] VoiceAudio → [SF1] Output → FW setting
- [PERFORM] → [EDIT] → [COMMON EDIT] → [F4] Audio In → [SF1] Output → FW setting
- [SONG]/[PATTERN] → [MIXING] → [EDIT] → [COMMON EDIT] → [F4] Audio In → [SF1] Output → FW setting

### FW Audio Channels of the MOTIF XF and the computer

When connecting the MOTIF XF to a computer via an IEEE1394 cable, set the audio channel of the computer referring to the table below.

Input Channel of the MOTIF XF	Output Channel of the computer
FW IN Main Out Monitor L, R	MOTIF XF6(7, 8) Main L and R
FW IN L, R	MOTIF XF6(7, 8) FW L and R
FW IN Assignable Out Monitor L, R	MOTIF XF6(7, 8) Asgn L and R
Output Channel of the MOTIF XF	Input Channel of the computer
FW OUT L, R (L&R)	MOTIF XF6(7, 8) Main L and R
FW OUT 1 – 14 (FW1 – FW14)	MOTIF XF6(7, 8) 1 – 14

## Song playback from a DAW using the MOTIF XF as a tone generator

The instructions below show how to use this instrument as a MIDI tone generator. In this case, actual MIDI sequence data is transmitted from a DAW or sequencer on the computer, allowing you to avoid using software synths and save processing power on your computer.

### Setting up the MOTIF XF

- 1 Press the [SONG] or [PATTERN] button to enter the Song mode or Pattern mode.**
- 2 Select the Song or Pattern to be edited.**
- 3 Press the [MIXING] button to call up the Mixing display.**
- 4 Set up the Mixing for parts 1 – 16 as necessary.**  
From the Mixing display, you can select the Voice and set various parameters such as pan, volume, balance between the chorus/reverb and dry sound, insertion effect on/off and arpeggio on/off.

### Setting up the DAW on the computer

- 1 Set the MIDI output port of the tracks for playing the MOTIF XF.**

When connecting via USB, set this to "Yamaha MOTIF XF6(7, 8)-1" or "Yamaha MOTIF XF Port1." When connecting via IEEE1394, set this to "MOTIF XF6(7, 8) Main."

**NOTE** When using Cubase as DAW, you can create an original Mixing setup of the MOTIF XF from the MOTIF XF Editor VST on your computer. The created Mixing setup can be saved as a Cubase Project file for future recall.

- 2 Enter the MIDI data to each track of the DAW on the computer.**

The tone generator settings of the part corresponding to the MIDI track will be set in the Mixing mode on the MOTIF XF.

**NOTE** By using the MOTIF XF Editor VST, you can create your own original Mixing setup of the MOTIF XF from your computer. The created Mixing setup can be saved as a file for convenient future recall.

## Recording your performance on the MOTIF XF to the DAW

The instructions below show how to use the MOTIF XF as a Master Keyboard. The note events you play on the MOTIF XF are transmitted and recorded to a track of a DAW/sequencer software on your computer, then returned back to the tone generator block of the MOTIF XF—allowing you to record your performance and properly hear it at the same time..

## Setting up the MOTIF XF

### 1 Set Local Control to “off.”

Press the [UTILITY] button to enter the Utility mode, then press [F5] followed by [SF2] to call up the MIDI display. Move the cursor to Local Control and set this parameter to “off.” When MIDI Thru is set to “on” in a DAW/sequencer software on your computer, the note events you play on the MOTIF XF are transmitted to the computer then returned back to the MOTIF XF, producing a “double” sound, since the tone generator block is receiving performance data (MIDI data) from both the keyboard directly and the computer. To prevent such a situation, you need to separate the keyboard block from the tone generator block of the MOTIF XF. This is why Local Control should be set to “off.”

**NOTE** Make sure to set the Local Control to “off” again when you use the MOTIF XF alone without connecting a computer. Otherwise, no sound is produced even if you play the keyboard.

### 2 Press the [STORE] button to store this setting.

### 3 Press the [SONG] or [PATTERN] button to enter the Song mode or Pattern mode when you want to use the MOTIF XF as a multi-timbral tone generator.

## Setting up the DAW on the computer

### 1 Set MIDI Thru to “on” on the DAW.

By setting MIDI Thru to “on,” the MIDI data generated by playing the keyboard and transmitted to the computer will be returned back to the MOTIF XF. As shown in the example below, the MIDI data transmitted from the MOTIF XF then recorded to the computer via MIDI channel 1 will be returned back from the computer to the MOTIF XF via MIDI channel 3 according to the setting of the recording track. As a result, the tone generator of the MOTIF XF will sound the MIDI data generated by playing the keyboard as the MIDI data of channel 3.

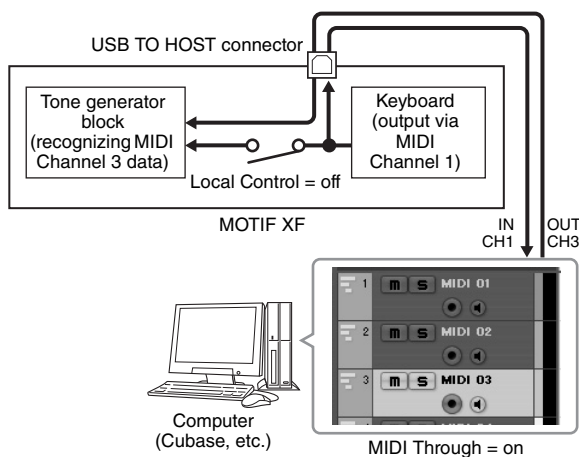

**NOTE** The above explanation applies when connecting the MOTIF XF to the computer via an IEEE1394 cable as well as via a USB cable.

## Using another tone generator together with the MOTIF XF

By using another tone generator (such as the MOTIF-RACK XS) together with the MOTIF XF as illustrated below, you can play up to 32 Parts simultaneously.

## Setting up the MOTIF XF

### 1 Connect the MIDI OUT connector to the MIDI IN connector of the external tone generator module such as MOTIF-RACK XS, as illustrated below.

### 2 Make sure to set the MOTIF XF to multi-timbral tone generator operation by entering the Song mode or Pattern mode.

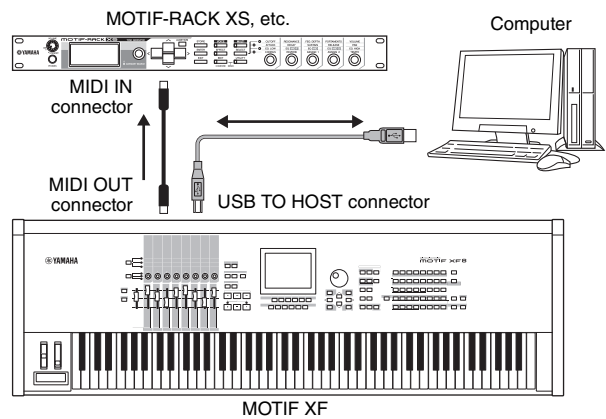

## Setting up the DAW on the computer

### 1 Set the MIDI output port of the tracks for playing the MOTIF XF.

When connecting via USB, set this to “Yamaha MOTIF XF6(7, 8)-1” or “Yamaha MOTIF XF6(7, 8) Port1.” When connecting via IEEE1394, set this to “MOTIF XF6(7, 8) Main.”

### 2 Set the MIDI output port of the tracks for playing the MOTIF-RACK XS.

When connecting via USB, set this to “Yamaha MOTIF XF6(7, 8)-3” or “Yamaha MOTIF XF6(7, 8) Port3.” When connecting via IEEE1394, set this to “MOTIF XF6(7, 8) MIDI Out.”

**NOTE** When connecting via USB, the MIDI Thru Port of the MOTIF XF (in other words, the port with which the received MIDI data is to be transmitted to another external device via the MIDI OUT connector) is fixed to 3. When connecting via IEEE1394, the MIDI Thru Port of the MOTIF XF is fixed to the port specified as “MOTIF XF6(7, 8) MIDI Out.”

## Using the MOTIF XF as an audio interface

By using the A/D INPUT connector and IEEE1394 connector, the MOTIF XF can conveniently be used as an audio interface for your computer. Note that you need install the optional FW16E for this application.

### Setting up the MOTIF XF

#### 1 Set the parameters as below so that the audio signal input via the A/D INPUT connector is output via the FW connector to the computer.

In the Voice mode, press the [UTILITY] button to enter the Utility mode, then press the [F4] button followed by the [SF1] button to call up the Output display. From this display, move the cursor to the Output Select of the A/D Input, then select one of the following settings: "FW1&2" – "FW9&10," "FW11&12" and "FW13&14."

#### 2 Set the parameters as below so that the audio signal that is output from the computer and input to the MOTIF XF via the IEEE1394 connector will be output from the OUTPUT L/R or ASSIGNABLE OUTPUT L/R connectors.

From the Output display called up in step 1, move the cursor to the Output Select of the FW, then select "L&R" or "asL&R."

**NOTE** The setting here applies to the audio signals output from FW ports MOTIF XF6(7, 8) FW L and R of a computer.

#### 3 Press the [STORE] button to store this setting.

### Setting up the DAW on the computer

Install the FW Driver and make the proper settings. Select Yamaha Steinberg FW ASIO (when using an ASIO driver) or Yamaha Steinberg FW WDM Audio (when using a WDM driver) as the Audio driver.

**NOTE** If using Cubase with the MOTIF XF Extension installed, starting Cubase will set the Audio Driver automatically, allowing you to easily confirm the Audio Port name.

## Remote-controlling the software (Remote mode)

The MOTIF XF features a highly convenient Remote mode which lets you control the DAW software and software synthesizer on your computer via the panel operations of the MOTIF XF. For example, you can start/stop playback of the DAW software on the computer by using the Function buttons and control the song position on the DAW software by using the data dial, [INC] and [DEC] buttons instead of using the mouse or keyboard of the computer.

The DAW applications Cubase, Logic Pro, SONAR and Digital Performer can be controlled by the Remote Control mode of the MOTIF XF.

This section explains how to control the DAW software from the MOTIF XF.

### What you can do with the Remote feature

The Remote Control lets you control the following operations.

- You can use the sliders, knobs and buttons of the MOTIF XF to control the sequencer tracks and mixer channels of the DAW on the computer.

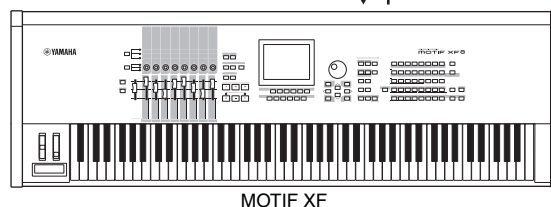
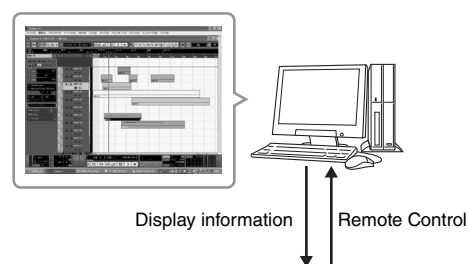

- You can view the parameter values on the LCD display of the MOTIF XF as well as on the computer display, since the values of the controlled parameters are returned back to the MOTIF XF from the computer.

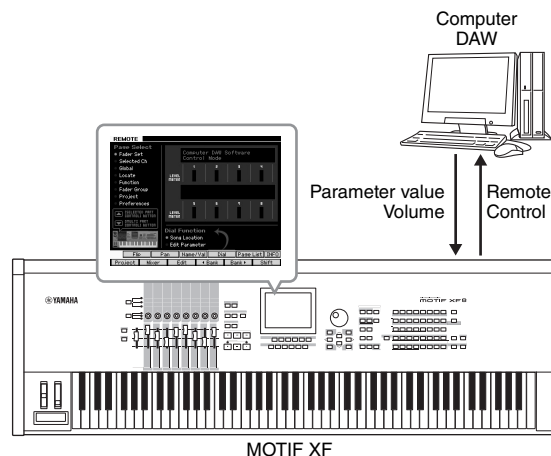

## Computer Software that can be controlled from the MOTIF XF

Cubase, SONAR, Logic Pro, Digital Performer

For information on connecting to a computer, refer to "Specifications" on page 79.

## Setting up for Remote Control

### Setting up the MOTIF XF

- 1** Connect this instrument to the computer via a USB cable.
- 2** Press the [UTILITY] button to enter the Utility mode, press the [F5] then [SF1] button to call up the Remote Setting display.
- 3** Set the DAW type to the desired DAW.
- 4** Press the [STORE] button to store this setting.
- 5** Start the DAW software on the computer connected to the MOTIF XF.

### Setting up the DAW of the computer

This section explains how to set up after starting each application.

**NOTE** When the cable between the MOTIF XF and the computer is disconnected or the MOTIF XF is turned off accidentally, the DAW may not recognize the MOTIF XF again even if you connect the cable again or turn the MOTIF XF back on. If this occurs, exit the DAW software, then restart it after setting up the MOTIF XF and making sure the connection is secure.

#### Important

Depending on the version of your DAW software, the actual procedure may be different from the following one, or the settings may even not be available. For details, refer to the manual of your DAW software.

#### ■ Cubase

When connecting the MOTIF XF and the computer via a USB cable or an IEEE1394 cable, installing the MOTIF XF Extension and starting Cubase will automatically make the settings of the Remote Device.

The MOTIF XF Extension can be downloaded via the following URL:

<http://www.yamahasyth.com/jp/downloads/>

- 1** Pull down the [Devices] menu and select [Device Setup] to call up the "Device Setup" window.
- 2** Click the [+] button and add the "Mackie Control" or "Yamaha MOTIF XF."
- 3** Select the device of "Mackie Control" or "Yamaha MOTIF XF" added to the list.
- 4** When the MOTIF XF Extension has not been installed, set the MIDI Input Port to "Yamaha MOTIF XF6(7, 8)-2" or "Yamaha MOTIF XF6(7, 8) Port2" or "MOTIF XF Remote,"

then set the MIDI Output Port to "Yamaha MOTIF XF6(7, 8)-2" or "Yamaha MOTIF XF6(7, 8) Port2" or "MOTIF XF Remote."

**NOTE** Unlike with the Mackie Control, the MOTIF XF does not support UserA and UserB (FootSw).

#### ■ SONAR

- 1** Pull down the [Options] menu and select [MIDI Devices] to call up the "MIDI Devices" window.
- 2** Add "Yamaha MOTIF XF-2" to the Input Device, then add "Yamaha MOTIF XF-2" to the Output Device.
- 3** Pull down the [Options] menu and select [Control Surfaces] to call up the Control Surface window.
- 4** Click the [+] button, select "Mackie Control," then set the Input Port to "Yamaha MOTIF XF-2" and set the Output Port to "Yamaha MOTIF XF-2."

#### ■ Digital Performer

- 1** In the Audio/MIDI setup of a Mac computer, connect Port 2 of the interface of the MOTIF XF to Port 2 of the tone generator. When there is only one Port for the tone generator, add the new Port, then connect it to the interface.
- 2** Pull down the [Setup] menu and select [Control Surfaces] to call up the Control Surface window.
- 3** Click the [+] button.
- 4** Select "Mackie Control" in the Driver section.
- 5** In the box for setting "Unit" and "MIDI," select "Mackie Control" in the "Unit" section and select "MOTIF XF New Port 2" in the "MIDI" section.

#### ■ Logic Pro

- 1** Select the [Preference] menu → [Control Surfaces] → [Settings] to call up the Settings window.
- 2** Select the [New] menu → [Install].
- 3** Select "Mackie Control" in the model, then add it as a control surface.
- 4** Set the MIDI Output Port to "Yamaha MOTIF XF-2."
- 5** Set the MIDI Input Port to "Yamaha MOTIF XF-2."

**NOTE** Mackie Control is a trademark of Mackie Designs, Inc.

**NOTE** For details about the button operations and functions, refer to the separate PDF manual.

## Controlling the DAW software from the MOTIF XF

To enter the Remote Control mode, press the REMOTE [ON/OFF] button (the lamp flashes). The REMOTE display appears (like those shown below), and the panel controls (such as buttons, knobs, sliders, and data dial) are enabled for Remote operation of the computer software (their normal functions are disabled). Press this button again to exit from the Remote Control mode.

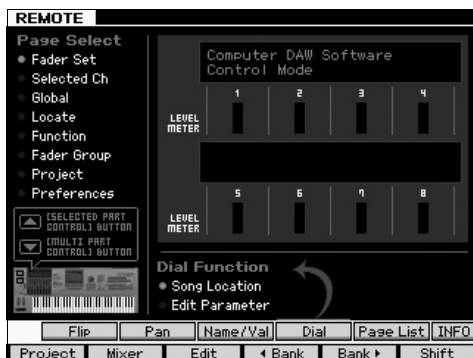

## Using the MOTIF XF Editor VST

The MOTIF XF Editor VST lets you edit the Voice in the Voice/Performance mode and Mixing setup in the Song/Pattern mode of the MOTIF XF from your computer, giving you even greater editing convenience. Because this software works as a VST3 plug-in software on Cubase, you can launch this software via the same operations as that of any other VST Instrument. Particularly When connecting via IEEE1394, the output information of the MOTIF XF will be shown on the Cubase Audio Mixer and can be controlled in the same way as any other VST Instrument. The data created on the MOTIF XF Editor VST is transferred between the computer and the MOTIF XF via a USB or IEEE1394 cable as bulk data. You can load files created on the MOTIF XF Editor VST to the MOTIF XF in the File mode via the LAN connection or by using a USB storage device. Furthermore, the data edited on the MOTIF XF is always synchronized with the data on the computer (MOTIF XF Editor VST) and vice versa. This provides a smooth, seamless interface, and makes it very easy to create and edit your data.

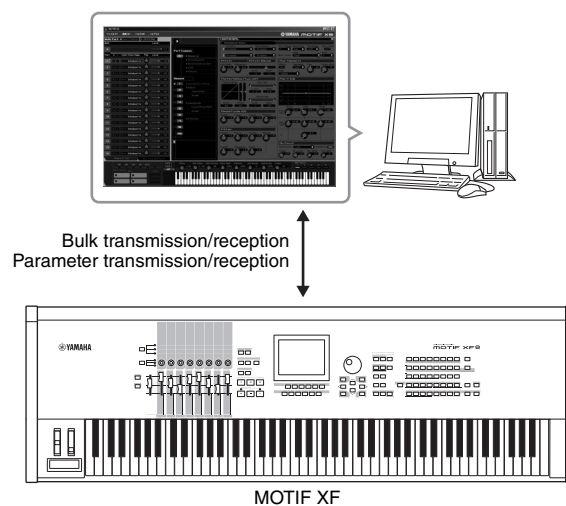

The MOTIF XF Editor VST can be downloaded from the following URL:  
<http://www.yamahasyth.com/>

The software such as Editor and Driver may be revised and updated without prior notice. For details and the latest information, refer to the above URL.

For instructions on using the MOTIF XF Editor VST, refer to the PDF manual included with the software.

# Saving / Loading Data in the File mode

In the File mode, you can save/load data such as Voice, Performance, Song, Pattern and Waveform created on this instrument. To enter the File mode, press the [FILE] button.

This section explains how to save/load all the data on the user memory of this instrument as an "All" file (extension: X3A).

## Saving the settings to a USB storage device

- 1 Connect a USB storage device to the USB TO DEVICE terminal of this instrument.
- 2 Press the [FILE] button to enter the File mode, then press the [F1] File button.

At the "Device" line, you can confirm that the connected USB storage device is mounted.

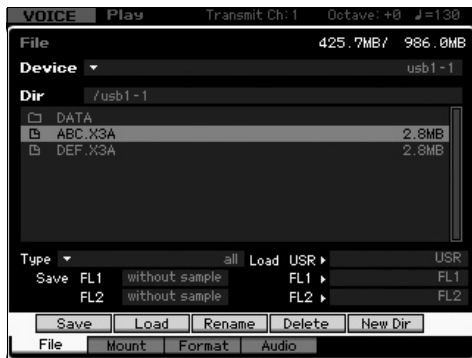

- 3 Move the path to the desired directory.  
The Dir line indicates the current directory name with the path and the lower box lists the directories and files belonging to the current directory.
  - 3-1 To go down from the current directory, move the cursor to the desired directory in the Directory/File list then press the [ENTER] button.
  - 3-2 To go up from the current directory, move the cursor to the top line in the Directory/File list then press the [ENTER] button.

**NOTE** If you wish to create a new directory and save the file there, press the [SF5] New Dir button.
- 4 Move the cursor to "Type" then select "all."
- 5 Press the [SF1] Save button to call up the window for entering the file name.
- 6 Enter the file name, then press the [ENTER] button.  
The confirmation message appears.  
The file name can contain up to 20 characters.
- 7 Press the [INC/YES] button to execute the Save operation.

## Loading the settings from a USB storage device

- 1 Connect a USB storage device to the USB TO DEVICE terminal of this instrument.
- 2 Press the [FILE] button to enter the File mode, then press the [F1] File button.

At the "Device" line, you can confirm that the connected USB storage device is mounted.



- 3 Move the path to the desired directory.  
The Dir line indicates the current directory name with the path and the lower box lists the directories and files belonging to the current directory.
  - 3-1 To go down from the current directory, move the cursor to the desired directory in the Directory/File list then press the [ENTER] button.
  - 3-2 To go up from the current directory, move the cursor to the top line in the Directory/File list then press the [ENTER] button.
- 4 Move the cursor to "Type" then select "all."
- 5 Select the file to be loaded.
- 6 Press the [SF2] Load button (a prompt for confirmation appears).  
Press the [DEC/NO] button to cancel the Load operation.
- 7 Press the [INC/YES] button to execute the Load operation.

### ■ NOTICE ■

The Load operation overwrites any data previously existing in the destination internal memory. Important data should always be saved to a USB storage device connected to the USB TO DEVICE terminal.

For more information about the File operation, refer to the File mode chapter in the Reference Manual.



## USB storage devices

### Connection Examples

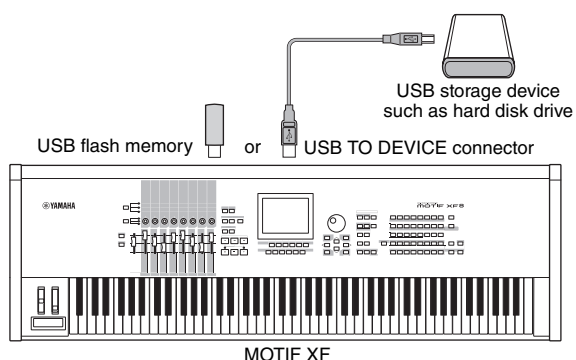

### Compatible USB devices

Connect only a USB storage device (such as hard disk, CD-ROM, flash memory and other drives) to the USB TO DEVICE connector. Other USB devices such as a mouse cannot be used. Both bus-powered (powered by the host device) or self-powered (battery or external power supply) types can be used. Before purchasing USB storage devices, please consult your Yamaha dealer, or an authorized Yamaha distributor (see list at end of the Owner's Manual) for advice, or see the following web page:  
<http://www.yamahasyth.com/>

**NOTE** Although CD-R/RW drives can be used to load data to the instrument, they cannot be used for saving data. However, you can transfer the data to a computer and save it to a CD using the CD-R/RW drive on the computer.

### Formatting USB storage media

When an unformatted USB storage device is connected to the USB TO DEVICE connector, the indication "unknown device (usb\*\*\*)" is shown in the device list on the [F3] Format window of the File mode. If this happens, execute the Format operation in the Format display. For information about the Format operation, refer to the Reference Manual.

**NOTE** The three asterisks (\*\*\*) in the example indication above denote the sequential serial numbers of the connected devices which need to be formatted. When several partitions are included in a single device, the partition number is indicated at the right of the serial number.

#### Notices when using the USB TO DEVICE terminal

Please keep in mind the following points:

Never turn the USB device's power on/off and never plug/unplug the USB cable when the connected USB storage device is the self-powered type. Doing so may result in the operation of the synthesizer "freezing" or hanging up. While the instrument is accessing data (such as in the Save, Load and Delete operations in the File mode), do NOT unplug the USB cable, do NOT remove the media from the device, and do NOT turn the power off to either device. Doing so may corrupt the data on either or both devices.

# Display Messages

LCD Indication	Description
Are you sure?	Confirms whether you want to execute a specified operation or not.
Arpeggio memory full.	The internal memory for Arpeggio data is full, preventing storing the recorded sequence data as an Arpeggio.
Bad disk or memory.	The external storage device connected to this synthesizer is unusable. Format the external storage device and try again.
Bulk data protected.	Bulk data cannot be received because of the setting in the Utility mode.
Can't access to the host	The MOTIF XF cannot access a host computer.
Can't execute to the Preset Wave.	This message appears when you try to save the preset Waveform to an external storage device.
Can't undo. Are you sure?	When certain Song/Pattern Jobs are executed, internal memory becomes too full for use of the Undo operation.
Completed.	The specified load, save, format, or other Job has been completed.
Confirmed password is invalid.	The new password cannot be registered because the confirmed password does not match the new password.
Connecting to USB device...	Currently recognizing the USB storage device connected to the USB TO DEVICE terminal.
Copy protected.	You have attempted to export or save a copy-protected digital audio source.
Device number is off.	Bulk data cannot be transmitted/received since the device number is off.
Device number mismatch.	Bulk data cannot be transmitted/received since the device numbers don't match.
Directory is not empty.	You have attempted to delete a folder that contains data.
Disk or memory is full.	The external storage device is full and no more data can be saved. Use a new external storage device, or make space by erasing unwanted data from the storage device.
Disk or memory is write-protected.	The external storage device is write protected, or you have attempted to write to a read-only medium such as CD-ROM.
Disk or memory read/write error.	An error occurred while reading or writing to/from an external storage device.
File already exists.	A file having the same name as the one you are about to save already exists.
File is not found.	The specified file was not found on the external storage device during a load operation.
File or directory path is too long.	The file or directory you tried to access cannot be accessed because the amount of characters indicating the path is too long.
FW identity ID check OK.	The MOTIF XF has been properly connected to the computer via an IEEE1394 cable.
Illegal bulk data.	An error occurred while receiving the Bulk data or Bulk Request message.
Illegal file name.	The specified file name is invalid. Try entering a different name.
Illegal file.	The file specified for loading is unusable by this synthesizer or cannot be loaded in the current mode.
Illegal parameters.	This message appears when trying to execute the Song Job or Pattern Job with invalid settings.
Illegal sample data.	The Sample file specified for loading is unusable by this synthesizer.
Keybank full	The maximum overall number of Key Banks has been exceeded when executing Sampling related operations including Jobs and Load.
MIDI buffer full.	Failed to process the MIDI data because too much data was received at one time.
MIDI checksum error.	An error occurred when receiving bulk data.
Mixing Voice full.	The Mixing Voice cannot be stored because the number of Voices already stored has exceeded the maximum capacity.
New Flash Memory Module. Please load waveform data.	This message appears when the Flash Memory Expansion Module (FL512M/FL1024M) which was installed in a different MOTIF XF has been installed to the current MOTIF XF. If this message appears, you should save the Waveform data (including the parameter settings) of the previous MOTIF XF to a USB storage device, connect the USB storage device to the current MOTIF XF, then load the Waveform data. This occurs because the Sample without the parameter settings cannot produce the proper sound.
No data.	When a Song/Pattern Job is executed, the selected track or range contains no data. Select an appropriate track or range. In addition, this message appears when a Job related to a Mixing Voice cannot be executed because the specified Mixing Voice is not available.
No Flash Memory Module installed or module is unformatted.	This message appears when no Flash Memory Expansion Module is installed or the unformatted Module has been installed.
No sample data.	This message appears when a Sample-related Job cannot be executed because the specified Sample is not available. This message appears also when you try loading the Waveform data via the "FL1/FL2 without sample" setting even though the corresponding Sample is not available on the Flash Memory Expansion Module.
Now collecting the information of the network...	This message appears while obtaining the network information.
Now executing Factory set...	Indicates this synthesizer is restoring the factory-programmed settings.
Now Installing data to Flash Memory Module	The Sample data is being copied to the Flash Memory Expansion Module.
Now loading...	Indicates that a file is being loaded.
Now receiving MIDI bulk data...	Indicates this synthesizer is receiving MIDI bulk data.

LCD Indication	Description
Now saving...	Indicates that a file is being saved.
Now scanning autoloading file.	Scanning for the files specified for Auto Load.
Now transmitting MIDI bulk data...	Indicates this synthesizer is transmitting MIDI bulk data.
Overwrite. Are you sure?	A save operation will overwrite data on the external storage device as destination, and this message confirms whether it is OK to continue or not. Press [INC/YES] or [DEC/NO] as required.
Password is invalid.	The password you input does not match the already registered password.
Password is too short.	The password you input to "New Password" is too short. Input at least five characters as a password.
Password is unspecified.	This message appears when setting the File Server Switch parameter to "ON" though a password has not been registered.
Phrase limit exceeded.	The maximum number of Phrases (256) has been exceeded when recording, executing a Pattern Job, or editing.
Please keep power on.	The data is being written to Flash ROM. Never attempt to turn off the power while data is being written to Flash ROM. Turning the power off while this message is shown results in loss of all user data and may cause the system to freeze (due to corruption of data in the Flash ROM). This may also result in the MOTIF XF being unable to properly start up the next time the power is turned on.
Please select User Voice.	This message appears when entering the File mode from the Performance mode and selecting a Part to which a preset Voice is assigned in the Waveform Load operation. Assign a User Voice to the destination Part then execute the Load operation.
Please stop sequencer.	The operation you have attempted to execute cannot be done during Song/Pattern playback.
Sample frequency is too low.	The sampling frequency is too low and the Frequency Convert Job cannot be executed.
Sample is too long.	The Sample size is too large and the Time Stretch Job cannot be executed.
Sample is too short.	The Sample length is too short and the Frequency Convert Job cannot be executed.
Sample memory full.	The Sample memory is full and further Sampling operations, Jobs, or load operations cannot be executed.
Sample Voice full.	The maximum overall number of Sample Voices has been exceeded when executing the Sampling related operations including Jobs and Load.
Scene stored.	The Song Scene has been stored to one of the [SF1] – [SF5] buttons.
Sequence memory full.	The internal memory for Sequence data is full, preventing any further operation (such as recording, editing, Job execution, MIDI reception/transmission, or loading from the external storage device). Try again after erasing unwanted Song, Pattern, or User Phrase data.
The edited sequence data will be discarded. Are you sure?	Indicates that the operation will delete the currently edited Song or Pattern.
The received MIDI bulk data's type is not compatible with the current mode/voice type.	This message appears when MIDI bulk data is received in a different mode other than the currently selected mode. The bulk data is received in the same mode as the transmitting mode. This message also appears when the Voice type (Normal Voice/Drum Voice) of the destination Mixing Parts is different from the bulk-dump-transferred Voice type. The destination Parts assigned to the same Voice type as the bulk-dump-transferred Voice type are selected.
This Performance uses User Voices.	The Performance you have loaded includes User Voice data. Check whether the Voice you saved exists at the appropriate User voice bank.
Too many Samples.	The maximum overall number of samples (8192) has been exceeded.
Unrecognized Flash Memory Module. Please format it.	An unformatted Flash Memory Expansion Module has been recognized. Execute the Format operation.
USB connection terminated. Press any button.	A break in the connection with the USB storage device has occurred because of an abnormal electric current. Disconnect the USB storage device from the USB TO DEVICE connector, then press any of the panel buttons.
Utility/Sequencer Setup settings stored.	The settings in the Utility mode have been stored.
Waveform full	The maximum overall number of Waveforms has been exceeded when executing the Sampling related operations including Jobs and Load.
When the checkbox is "on," all user data is initialized the next time the power is turned on.	(Self-explanatory)

# Troubleshooting

No sound? Wrong sound? When a problem like this occurs, please check the following points before assuming that the product is faulty. You may solve your problem by executing the Factory Set (page 18) after backing up your data to an external storage device. If the problem persists, consult your Yamaha dealer.

## No Sound.

- Are all eight sliders set to appropriate levels (other than zero or minimum)?
- Is the MOTIF XF properly connected to related external equipment (e.g., amplifier, speaker, headphone) via audio cables? Since the MOTIF XF has no built-in speakers, you will need an external audio system or a set of stereo headphones to properly monitor it.
- Check the Local Control parameter and the FW Monitor Setup parameter in the Utility mode.  
When the MOTIF XF is used by itself and the Local Control parameter is set to off or the FW Monitor Setup parameter is set to "with PC," no sound is produced even if you play the keyboard.

[UTILITY] → [F5] Control → [SF2] MIDI → Switch → Local Control

[UTILITY] → [F2] I/O → FW Monitor Setup

- Is the power of this synthesizer and any external equipment connected to this synthesizer turned on?
- Have you made all the appropriate level settings—including the Master Volume on this synthesizer and the volume settings on any connected external equipment?
- Is the Foot Controller pressed down (when it is connected to the FOOT CONTROLLER jack)?
- Are the MIDI volume or MIDI expression settings too low when using the external controller?
- Is this synthesizer properly connected to related external equipment (e.g., amplifier or speaker) via audio cables?
- Are the effect and filter settings appropriate?  
If you are using the filter, try changing the cutoff frequency. Some cutoff settings may filter out all of the sound.

[VOICE] → [EDIT] → [COMMON EDIT] → [F6] Effect

[PERFORM] → [EDIT] → [COMMON EDIT] → [F5] Effect

[SONG]/[PATTERN] → [MIXING] → [F5] Effect

[VOICE] → [EDIT] → Element/Key selection → [F3] Filter

[PERFORM] → [EDIT] → Part selection → [F4] EG → Filter

[SONG]/[PATTERN] → [MIXING] → [EDIT] → Part selection → [F4] EG → Filter

[PERFORM]/[SONG]/[PATTERN] → [SEQ SETUP] → [F2] MIDI Filter

- Are the volume or expression settings too low?

[UTILITY] → [F1] General → [SF1] Play → Volume

[VOICE] → [EDIT] → [COMMON EDIT] → [F1] General → [SF2] Play Mode → Volume

[VOICE] → [EDIT] → Element/Key selection → [F4] Amplitude → [SF1] Level/Pan → Level

[PERFORM] → [EDIT] → [COMMON EDIT] → [F2] Level/MEF → [SF1] Level → Volume

[PERFORM] → [EDIT] → Part selection → [F1] Voice → [SF1] Voice → Volume

[SONG]/[PATTERN] → [MIXING] → [F1] Part 1-16 → Volume

- Are the parameter settings such as Element Switch, Part Switch, Note Limit and Velocity Limit appropriate?

[VOICE] → [EDIT] → Element/Key selection → [F1] Oscillator

[PERFORM] → [F2] Voice

[PERFORM] → [EDIT] → Part selection → [F1] Voice → [SF1] Voice → Part Switch

- When the Element to which "Legato" of the XA Control parameter is assigned does not sound, is the Mono/Poly parameter of the Element set to "Mono"? Or, is a value other than "Legato" of the XA Control parameter assigned to another Element within an Element Group?

[VOICE] → [F2] Porta → Mono/Poly Mode = mono

[VOICE] → [EDIT] → Element selection → [F1] Oscillator → XA Control

[VOICE] → [EDIT] → Element selection → [F1] Oscillator → Element Group

- When the Element to which “Key Off Sound” of the XA Control parameter is assigned does not sound, are you releasing the note after the AEG decays?

The “Key Off Sound” Element will take over the AEG level of the previous Element if both the Elements belong to the same Element Group. To solve such a problem, release the note before the AEG level decays to minimum or set the “Key Off Sound” Element to a different Element Group from the previous Elements.

[VOICE] → [EDIT] → Element selection → [F1] Oscillator → Element Group

- When the Element to which “AF1 on,” “AF2 on,” or “all AF off” of the XA Control parameter is assigned does not sound, is the corresponding ASSIGNABLE FUNCTION button pressed?

- Is “Vocoder” selected as the Insertion Effect Type of the Voice?

If so, set the parameters related to the AD Part and A/D INPUT connector to the appropriate values then play the keyboard while inputting your voice into the microphone connected to the MOTIF XF. Check whether or not the Gain Knob on the rear panel is set to the minimum position. For details, see page 47.

[VOICE] → [EDIT] → [COMMON EDIT] → [F6] Effect → [SF1] Connect → INSERTION CONNECT

[VOICE] → [UTILITY] → [F4] Voice Audio → [SF1] Output → Output Select = InsL

[VOICE] → [UTILITY] → [F2] I/O → Input → Mic/Line = mic

- When playing the keyboard in the Performance/Song/Pattern mode produces no sound, has a Voice been properly assigned to each Part?

[PERFORM] → [F2] Voice

[SONG]/[PATTERN] → [MIXING] → [F1] Part 1-16

- When Song/Pattern playback produces no sound, are the output channel of each track in the play mode and the receive channel of each Part in the Mixing mode set appropriately?

[SONG] → [F3] Track → [SF1] Out

[PATTERN] → [F3] Track

[SONG]/[PATTERN] → [MIXING] → [EDIT] → Part selection → [F1] Voice → [SF1] Voice → Receive Channel

- When Song/Pattern playback produces no sound, are the Velocity Rate and Velocity Offset settings of the Play FX appropriate?

[SONG]/[PATTERN] → [F2] Play FX → Velocity Offset

- No sound is produced when the ARP Play Only parameter is set to on and one of the following situations occurs.

- When the [ARPEGGIO ON/OFF] button is turned off.
- When the ARP Switch parameter of the corresponding Part is set to off.
- When no Arpeggio Type is assigned to the current Voice.

## Playback continues without stopping.

- When the [ARPEGGIO ON/OFF] button is turned on, press it so that its lamp is turned off.

- When in the Song mode or Pattern mode, press the [■] (Stop) button.

- When the click sound continues, check the following parameter setting. Set this parameter to something other than “always” because this setting always plays back the click sound regardless of the sequencer status.

[PERFORM]/[SONG]/[PATTERN] → [SEQ SETUP] → [F1] Click → Mode

## Distorted sound.

- Are the effect settings appropriate?

Use of an effect at certain settings may produce distortion.

[VOICE] → [EDIT] → [COMMON EDIT] → [F6] Effect

[PERFORM] → [EDIT] → [COMMON EDIT] → [F5] Effect

[SONG]/[PATTERN] → [MIXING] → [F5] Effect

Use of the Master Effect at certain settings may produce distortion.

[VOICE] → [UTILITY] → [F3] Voice → [SF1] Master FX

[PERFORM] → [EDIT] → [COMMON EDIT] → [F2] Level/MEF → [SF2] Master FX

[SONG]/[PATTERN] → [MIXING] → [EDIT] → [COMMON EDIT] → [F2] Master FX → [SF2] Master FX

- Are the filter settings appropriate?

Excessively high filter resonance settings can cause distortion.

[VOICE] → [EDIT] → Element/Key selection → [F3] Filter

[PERFORM] → [EDIT] → Part selection → [F4] EG → Filter

[SONG]/[PATTERN] → [MIXING] → [EDIT] → Part selection → [F4] EG → Filter

- Is any of the following volume parameters set so high that clipping is occurring?

[UTILITY] → [F1] General → [SF1] Play → Volume

[VOICE] → [EDIT] → [COMMON EDIT] → [F1] General → [SF2] Play Mode → Volume

[PERFORM] → [EDIT] → [COMMON EDIT] → [F2] Level/MEF → [SF1] Level → Volume

[SONG]/[PATTERN] → [MIXING] → [F1] Part 1-16 → Volume

## Sound is cut off.

- Is the entire sound (via your keyboard playback and Song/Pattern/Arpeggio playback) exceeding the maximum polyphony of the MOTIF XF?

For information about the maximum polyphony, refer to the Reference Manual.

## Only one note sounds at a time.

- When this situation occurs, the Mono/Poly parameter in the current mode is set to “mono.” If you wish to play chords, set this parameter to “poly.”

[VOICE] → [F2] Porta → Mono/Poly Mode

[PERFORM] → [EDIT] → Part selection → [F1] Voice → [SF1] Voice → Mono/Poly

[SONG]/[PATTERN] → [MIXING] → [EDIT] → Part selection → [F1] Voice → [SF1] Voice → Mono/Poly

## Pitch or intervals are wrong.

- Is the Master Tune parameter in the Utility mode set to a value other than “0”?

[UTILITY] → [F1] General → [SF1] Play → Tune

- Is the Note Shift parameter in the Utility mode set to a value other than “0”?

[UTILITY] → [F1] General → [SF1] Play → Note Shift

- When the voice produces a wrong pitch, is the appropriate tuning system selected from Micro Tuning parameter in the Voice Edit mode?

[VOICE] → [EDIT] → [COMMON EDIT] → [F1] General → [SF2] Play Mode → Bank, Tuning Number, Tuning Root

- When the Voice produces a wrong pitch, is the LFO Pitch Modulation Depth in the Voice Edit mode set too high?

[VOICE] → [EDIT] → Element/Key selection → [F5] Elm LFO → P Mod

- When the Performance/Song/Pattern produces a wrong pitch, is the Note Shift parameter of each Part set to a value other than “0”?

[PERFORM] → [EDIT] → Part selection → [F1] Voice → [SF1] Voice

[SONG]/[PATTERN] → [MIXING] → [EDIT] → Part selection → [F1] Voice → [SF1] Voice

- When the Song/Pattern playback produces a wrong pitch, is the Note Shift parameter in the Play FX display set to a value other than “0”?

[SONG]/[PATTERN] → [F2] Play FX → Note Shift

## No effect is applied.

- Is the [EFFECT BYPASS] button turned off?

- Have the REVERB and CHORUS knobs been turned fully counter-clockwise (to the minimum)?

- Have any or all of the Elements' Insertion Effect Output parameters been set to “thru” in the effect setting display in the Voice Edit mode?

[VOICE] → [EDIT] → [COMMON EDIT] → [F6] Effect → [SF1] Connect → Element Out 1-8

- Have any or all of the effect types been set to “thru” or “off”?

- When this occurs in the Performance mode/Song mode/Pattern mode, check whether the Insertion Switch (INS SW) parameters are set properly or not.

[PERFORM] → [EDIT] → [COMMON EDIT] → [F5] Effect → [SF2] InsSwitch

[PERFORM] → [EDIT] → Part selection → [F1] Voice → [SF1] Voice

[SONG]/[PATTERN] → [MIXING] → [F1] Part 1-16 → Ins FX Sw

[SONG]/[PATTERN] → [MIXING] → [COMMON EDIT] → [F5] Effect → [SF2] Ins Switch

## The Edit Indicator appears, even when parameters are not being edited.

- Keep in mind that even though the Edit mode is not active, simply moving a Knob/Slider or playing back the Song/Pattern changes the current Voice, Performance, or Mixing, causing the Edit Indicator to appear.

## Cannot start the Arpeggio.

- Check whether the [ARPEGGIO ON/OFF] button is turned on or off.

- Is the MIDI Sync parameter set to internal (using internal clock)?

[UTILITY] → [F5] Control → [SF2] MIDI → MIDI Sync = internal

- When the User Arpeggio type is selected, does the currently selected Arpeggio actually contain data?

- Are the Arpeggio related parameters such as Note Limit and Velocity Limit set appropriately?

[VOICE] → [EDIT] → [COMMON EDIT] → [F2] ARP Main

[PERFORM] → [EDIT] → Part selection → [F2] ARP Main

[SONG]/[PATTERN] → [MIXING] → [EDIT] → Part selection → [F2] ARP Main

- When this situation occurs in the Performance/Song/Pattern mode, check the Arpeggio Switch parameter. If this parameter for the current Part is set to off, Arpeggio playback will not be triggered by your keyboard performance even if the [ARPEGGIO ON/OFF] button is turned on.

[PERFORM] → [F4] Arpeggio → Common Switch

[PERFORM] → [EDIT] → Part selection → [F2] ARP Main → Switch

[SONG]/[PATTERN] → [MIXING] → [EDIT] → Part selection → [F2] ARP Main → Switch

## Cannot stop the Arpeggio.

- When Arpeggio playback does not stop even if you release the key, set the Arpeggio Hold parameter to “off.”

[VOICE] → [EDIT] → [COMMON EDIT] → [F2] ARP Main → Hold

[PERFORM] → [EDIT] → Part selection → [F2] ARP Main → Hold

[PERFORM] → [PERFORMANCE CONTROL] → Number buttons [13] – [16]

[SONG]/[PATTERN] → [MIXING] → [EDIT] → Part selection → [F2] ARP Main → Hold

## The Voice assigned to the Performance produces a different sound from the one in the Voice mode.

- This is normal because the Voice sound is determined by the parameter settings in the Performance mode. For the Performance Parts, you will need to apply basically the same parameter settings as those used in the Voice mode. Regarding the Effect settings except for the send level, you can copy the settings in the Voice mode to the Performance part in the following display. By executing this Job, you can ensure that the Voice will sound the same in the Performance mode as it does in the Voice mode.

[PERFORM] → [JOB] → [F3] Copy → [SF2] Voice

[PERFORM] → [EDIT] → Part selection → [F1] Voice → [SF2] Output → Reverb Send/Chorus Send

## The Song/Pattern cannot be started even when pressing the [▶] (Play) button.

- Does the selected Song or Pattern (phrase) actually contain data?

- Is the Remote Control feature turned on?

- Is the MIDI Sync parameter set to internal (using internal clock)?

[UTILITY] → [F5] Control → [SF2] MIDI → MIDI Sync = internal

### **Song/Pattern (Phrase) cannot be recorded.**

- Is there enough free memory for recording?

Check the available amount of the sequencer memory on the Song Information window (called via [SONG] → [F2] → [SF6]) or Pattern Information window (called via [PATTERN] → [F2] → [SF6]).

The total MOTIF XF memory capacity determines the number of Songs/Patterns (phrases) that can be recorded. For example, if the memory contains Songs/Patterns (phrases) that use up a large amount of memory, the memory may become full even though the available Pattern or Song numbers are not all used.

### **Cannot enter the Pattern Job mode/Pattern Mixing mode even when pressing the [JOB] button in the Pattern mode.**

- Check whether the MOTIF XF is in the Pattern Chain mode or not.

If so, exit from the Pattern Chain mode, then press the [JOB] button or [MIXING] button.

### **The drum sound is wrong or unexpected when changing the transpose value in the Song/Pattern Play mode.**

- This is normal. Changing the transpose setting while playing a Drum Voice will produce different sounds for the same keys played.

### **Microphone does not work properly.**

- Check whether the Mic/Line parameter is set to “mic” or not.

[UTILITY] → [F2] I/O → Mic/Line = mic

- Check whether the Gain Knob on the rear panel is set to minimum position or not.

### **Cannot record samples.**

- Have you exceeded the maximum allowable number of samples (key banks)?
- Is there enough sample memory available?
- Is the Sampling Source setting appropriate?
- Is the Trigger mode set appropriately?

### **Data communication via MIDI/USB/IEEE1394 between the computer and the MOTIF XF does not work properly.**

- Check whether the Port settings on the computer are appropriate or not.
- Check whether or not the MIDI IN/OUT parameter is set to the appropriate value.

[UTILITY] → [F5] Control → [SF2] MIDI → MIDI In/Out

### **The MOTIF XF does not sound properly even when playing back the Song data on the computer or the MIDI instrument connected to the MOTIF XF.**

- Make sure to set the MOTIF XF to the Song mode or Pattern mode. The Voice mode or Performance mode may not produce the proper sound even when playing back the Song data on the MIDI instrument or the computer connected to the MOTIF XF.



## Network connection does not work.

- If you've forgotten the password for accessing the MOTIF XF, execute the Factory Set then set the password again.

[UTILITY] → [F1] General → [SF3] Network → [SF5] Password

- When the DHCP server is connected to the network and the DHCP Client parameter is set to "on," you need not set the IP address because it is automatically set. When the DHCP server is not connected to the network and you wish to set a specific IP address, set the DHCP Client parameter to "off," then set the IP address manually.

[UTILITY] → [F1] General → [SF3] Network → DHCP Client

- If the network settings do not become active even if you set the related parameters, make sure to press the [ENTER] button after setting. Then, you will need to press the [STORE] button to store the settings. If you do not store the network settings, these will be erased after you turn off the power.

[UTILITY] → [F1] General → [SF3] Network

- The characters of a file or directory may be garbled when loading the file from the computer drive to the MOTIF XF. If such a problem occurs, replace the garbled character with the correct one on the MOTIF XF display. Keep in mind that 2-byte character codes such as Kanji and Kana cannot be shown on the display of the MOTIF XF.

- When "Password is unspecified." appears after setting the File Server parameter to "on," make sure to set the Password before setting the File Server parameter to "on." This is because the Security parameter has been set to "workgroup" and the Account and Password are necessary when the files are shared.

[UTILITY] → [F1] General → [SF3] Network → [SF5] Password

## MIDI bulk data transmission/reception does not work properly.

- Is the Receive Bulk parameter set to off?  
Set the Receive Bulk parameter to on.

[UTILITY] → [F5] Control → [SF2] MIDI → Receive Bulk

- When receiving MIDI bulk data transmitted via the Bulk Dump function and recorded to the external MIDI device, you need to set the MIDI Device Number to the same value as when transmitting.

[UTILITY] → [F5] Control → [SF2] MIDI → Device Number

- When transmission does not work properly, is the device number of the MIDI instrument connected to the MOTIF XF set to match the Device Number Parameter in the Utility mode?

[UTILITY] → [F5] Control → [SF2] MIDI → Device Number

## Cannot save data to the external USB storage device.

- Is the USB storage device being used write protected? (Write-protect should be set to off for saving data.)
- Is the USB storage device being used properly formatted?  
Press the [FILE] button to enter the File mode, then set the device to the USB storage device. Check the amount of currently available (unused) memory of the USB storage device indicated at the right top of the display.
- Is operation of the USB storage device guaranteed by Yamaha?  
For details, see page 65.

# Installing Optional Hardware

## Available devices

The following optional devices can be installed to the MOTIF XF.

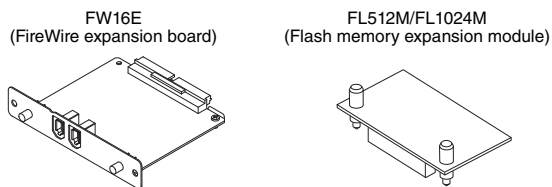

## Installation locations

### FW16E (FireWire expansion board)

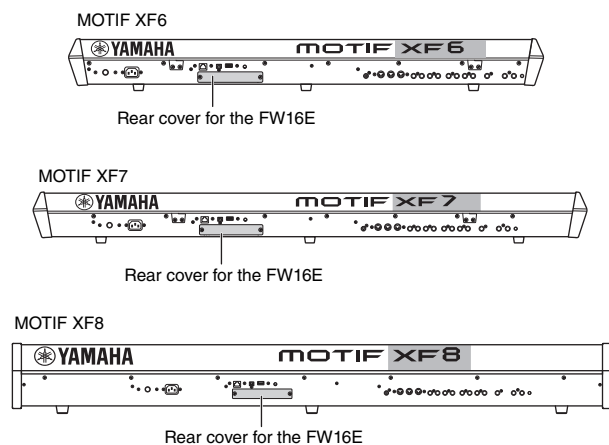

### FL512M/FL1024M (Flash memory expansion module)

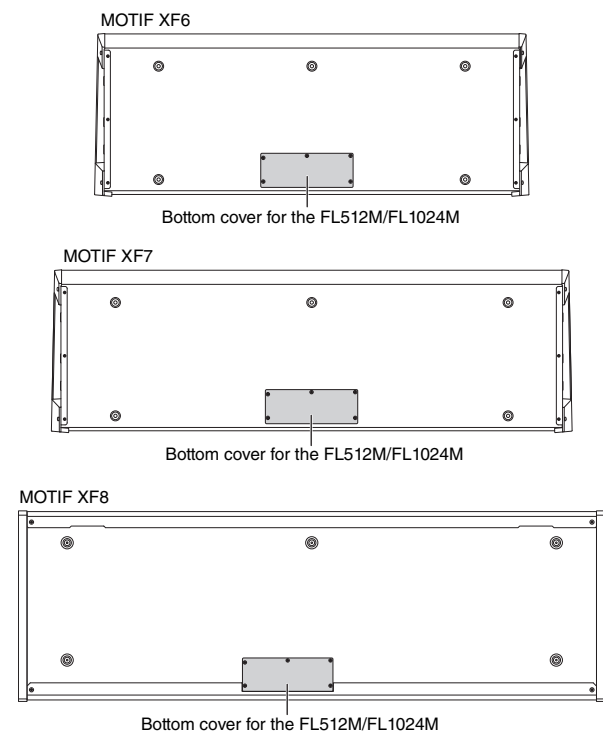

## Installation Precautions

Before installing the optional hardware, make sure you have a Phillips screwdriver and ample space to work.

### WARNING

- Before beginning installation, switch off the power to the instrument and connected peripherals, and unplug them from the power outlet. Installation or removal of any devices should be started **ONLY** after the instrument (and the optional hardware) returns to normal room temperature. Then remove all cables connecting the instrument to other devices. (Leaving the power cord connected while working can result in electric shock. Leaving other cables connected can interfere with work.)
- Be careful not to drop any screws inside the instrument during installation. (This can be prevented by keeping the optional units and cover away from the instrument while attaching). If this does happen, be sure to remove the screw(s) from inside the unit before turning the power on. Loose screws inside the instrument can cause improper operation or serious damage. If you are unable to retrieve a dropped screw, consult your Yamaha dealer for advice.
- Install the optional units carefully as described in the procedure below. Improper installation can cause shorts which may result in irreparable damage and pose a fire hazard.
- Do not disassemble, modify, or apply excessive force to board areas and connectors on optional units. Bending or tampering with boards and connectors may lead to electric shock, fire, or equipment failures.

### CAUTION

- It is recommended that you wear gloves to protect your hands from metallic projections on optional units and other components. Touching leads or connectors with bare hands may cause finger cuts, and may also result in poor electrical contact or electrostatic damage.
- Be careful of static electricity. Static electricity discharge can damage the IC chips on the FW16E. Before you handle the optional FW16E, to reduce the possibility of static electricity, touch unpainted metal parts or a ground wire on the devices that are grounded.
- Handle the optional units with care. Dropping or subjecting them to any kind of shock may cause damage or result in a malfunction.
- Do not touch the exposed metal parts in the circuit board. Touching these parts may result in a faulty contact.
- Be careful not to misplace any of the screws.
- Do not use any screws other than what are installed on the instrument. Use of incorrect screws can cause damage.

## FW16E

**1** Turn the power of the MOTIF XF off, and disconnect the AC power cord. Also, make sure to disconnect the MOTIF XF from any connected external devices.

**2** Remove the cover for the FW16E from the rear panel.

With the rear panel of this synthesizer facing you, remove the two screws from the cover.

### Important

Keep the removed screws in a safe place. They will be used when installing the FW16E. Be careful not to misplace them. Keep the cover and fixing screws in a safe place for future use.

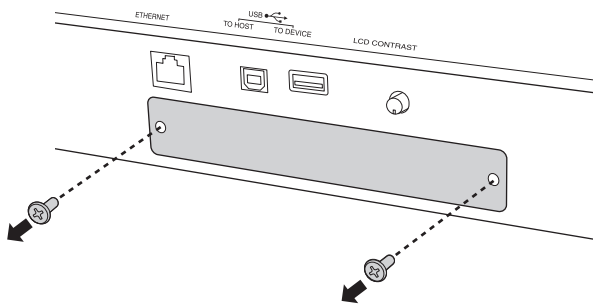

### CAUTION

After removing the cover, you will see the metal fittings at the bottom of the opening. To avoid cutting or scraping your fingers, be careful not to touch them when installing the FW16E.

**3** Insert the FW16E along the guide rails.

Push the FW16E all the way into the slot so that the connector at the end of the FW16E is correctly inserted into the connector inside the slot.

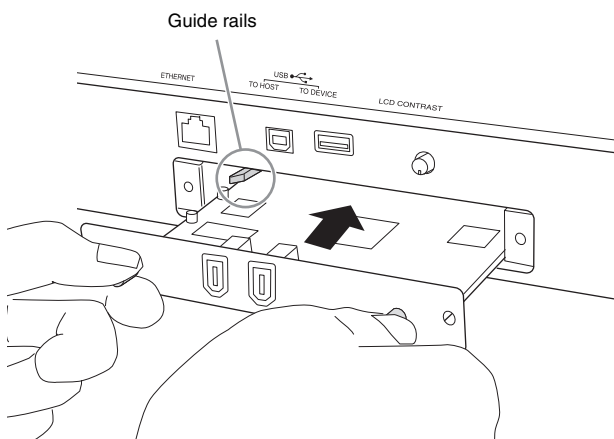

**4** Replace the cover with the two screws you removed in step 2 above.

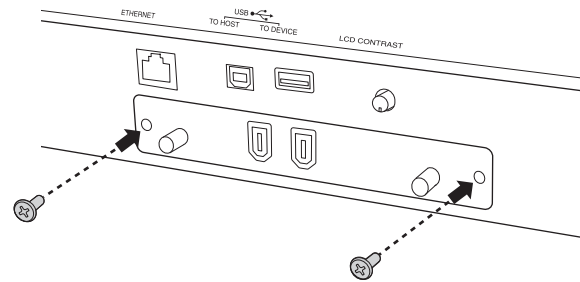

### NOTICE

Malfunctions or incorrect operation may occur if the FW16E is not properly fastened.

For information on connecting to a computer, refer to "Using the IEEE1394 terminal" on page 57.

## FL512M/FL1024M

### Configuration

Two types of the Flash Memory Expansion Module are available as follows:

- **FL512M**

Features a memory size of 512 MB.

- **FL1024M**

Features a memory size of 1024 MB.

In the MOTIF XF, two slots are available, meaning that up to two Modules can be installed to the MOTIF XF. Available memory size for each case is as follows:

Modules to be installed	Available memory size
FL512M	512 MB
FL1024M	1024 MB
FL512M + FL512M	1024 MB
FL512M + FL1024M	1536 MB
FL1024M + FL1024M	2048 MB

### Installation Procedure

**1 Turn the power of the MOTIF XF off, and disconnect the AC power cord. Also, make sure to disconnect the MOTIF XF from any connected external devices.**

**2 Turn over the MOTIF XF so that the keyboard faces down, giving you direct access to the underside of the instrument.**

To protect the Knobs, Wheels and Sliders from damage, place the keyboard so the four corners are supported by something that provides sufficient support like magazines or cushions. Place supports at all four corners, taking care not to touch the Knobs, Wheels and Sliders.

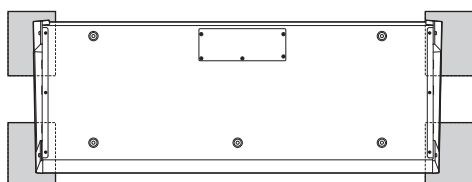

View of the keyboard from the bottom

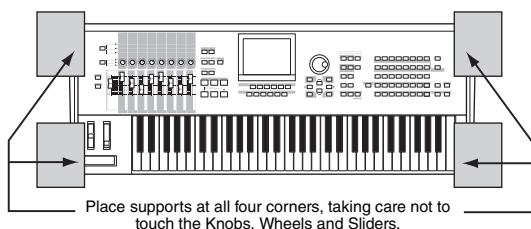

#### CAUTION

Since the instrument—particularly the MOTIF XF8—is very heavy, this procedure should not be done alone, but by two or three people.

**3 Remove the cover from the bottom.**

With the rear panel of the MOTIF XF facing you, remove the screws from the cover by using the Phillips screwdriver. After removing the screws, slide the cover away to remove it.

#### Important

Keep the removed screws in a safe place. They will be used when re-attaching the cover to the instrument after installation.

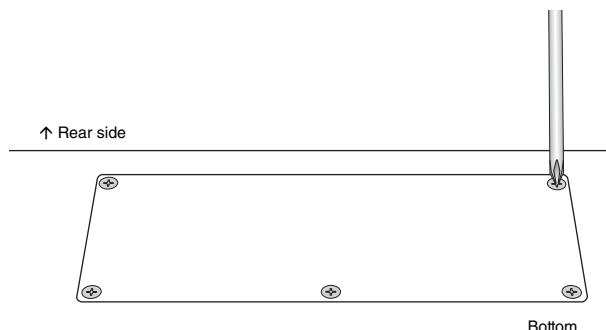

**4 Attach the FL1024M or FL512M to the slots.**

As shown below, two slots are available.

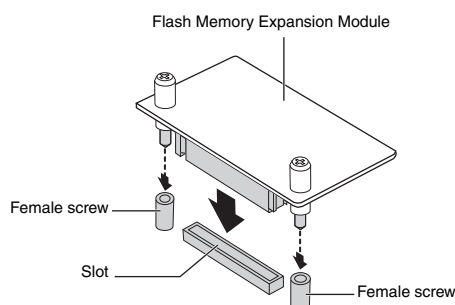
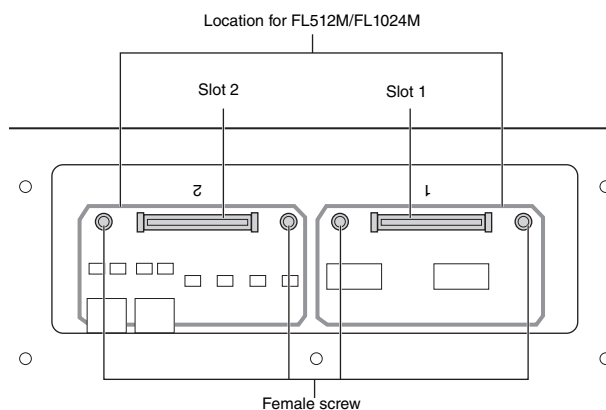

Attach the module to either of the slots via the following steps.

**4-1** Insert the Module vertically in the slot and face the screws (of the Module) to the female screws respectively.

**NOTE** Either slot can be inserted.

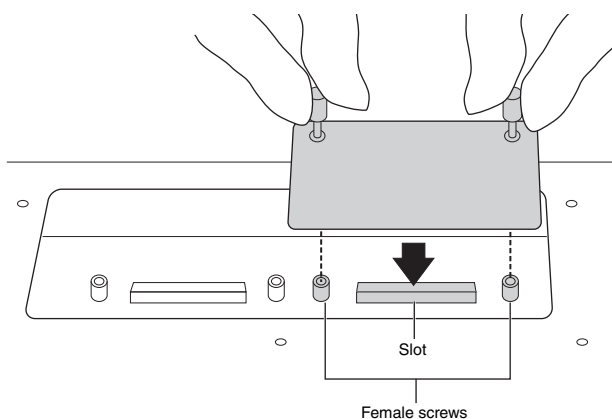

**4-2** Press the top of the connector as shown, then push the connector firmly into the slot.

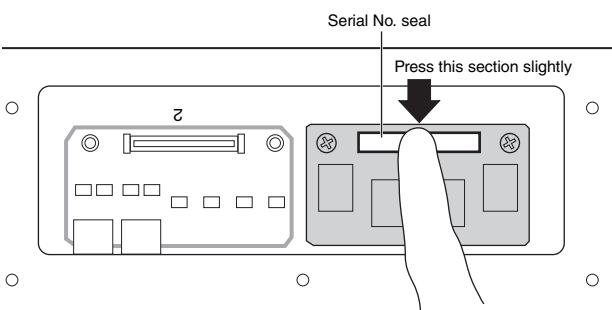

**4-3** Tighten each screw of the Memory Module to each female screw of the MOTIF XF with your hand as shown below.

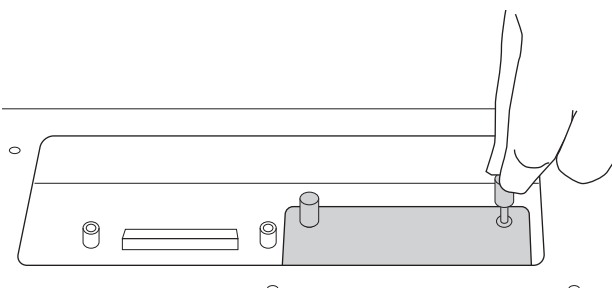

**4-4** Attach another Module to the other slot, as desired.

**5** Re-install the cover you removed in step 3, in reverse order.

**6** Check that the installed Module or Modules are functioning properly.

**6-1** Turn over the MOTIF XF so that the keyboard faces up then turn the power on. While launching, you will see the message indicating that the Flash Memory Module cannot be recognized.

**6-2** Press the [UTILITY] button to enter the Utility mode then press the [F6] Flash button.

**6-3** At the top left corner of this display, select the Flash Memory Module number, "FL1" or "FL2."

**NOTE** The FL512M/FL1024M has been installed properly if an "Unformatted" indication appears at the right of the slot

number on the display; "Unmounted" is shown if it is not. If "Unmounted" is shown though you have installed the Module, execute the instructions again from step 1 then check whether or not the Module has been installed properly.

**6-4** Press the [SF3] Format button to execute the Format operation.

**NOTICE**

If you installed a second Memory Module in addition to the first one, do not format the first Memory Module. Doing so will erase your important data in the first Memory Module. Before executing the format operation, make sure that "Unformatted" is shown at right of the Slot number ("FL1" or "FL2") on the display.

**6-5** If necessary, format the other Module by executing 6-3 and 6-4 again.

**6-6** Check whether the Total size shown on the display is correct or not. When only one FL512M has been installed, "Total size 510M" is shown.

## Removing the Module

**1** Loosen both the screws.

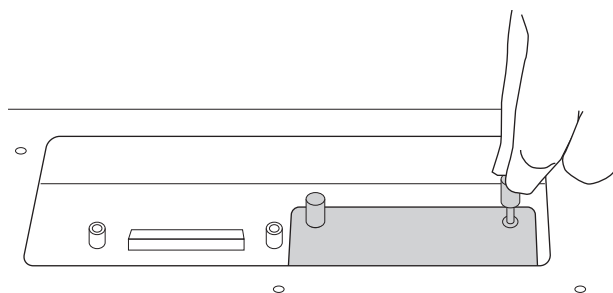

**NOTICE**

- If you cannot loosen the screw with your hand, use a Phillips screwdriver. In this case, be careful NOT to scratch the circuit board of the FL512M/FL1024M and MOTIF XF.
- Since the screws can be removed from the module, be careful NOT to drop them inside the instrument when loosening them.

**2** Pull out the FL512M/FL1024M vertically.

**3** Attach the cover to the bottom panel.

Locate the cover on the bottom panel so that screw holes are fit then tighten the five screws with a Phillips screwdriver to fix the cover.

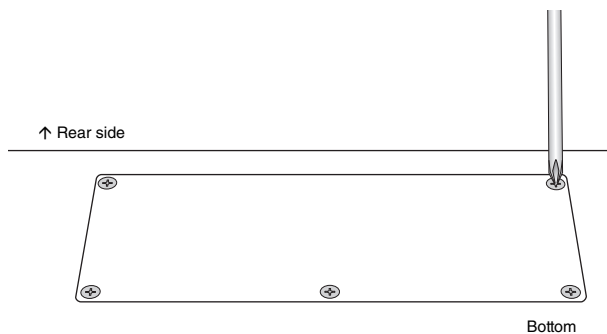

# Specifications

<b>Keyboards</b>	MOTIF XF8	88 keys, Balanced Hammer Effect Keyboard (Initial Touch/Aftertouch)	
	MOTIF XF7	76 keys, FSX Keyboard (Initial Touch/Aftertouch)	
	MOTIF XF6	61 keys, FSX Keyboard (Initial Touch/Aftertouch)	
<b>Tone Generator block</b>	Tone Generator	AWM2, with Expanded Articulation	
	Polyphony	128 notes	
	Multi Timbral Capacity	16 Parts (internal), Audio Input Parts (A/D, FW*) *1 stereo Part	
	Wave	741 MB (when converted to 16-bit linear format), 3,977 waveforms	
	Voice	Preset: 1,024 Normal Voices + 64 Drum Kits GM: 128 Normal Voices + 1 Drum Kit User: 128 x 4 (Bank 1: original, Bank 2 – 4: selected and copied from Preset bank) + 32 Drum Kits (No. 1 – 8: original, No. 9 – 32: selected and copied from Preset bank)	
	Performance	User: 128 x 4 (up to 4 Parts)	
	Filter	18 types	
	Effect System	Reverb x 9 types, Chorus x 22 types, Insertion (A, B) x 53 types x 8 Parts (up to 16 units), Vocoder x 1 (uses both Insertion Effect A and B blocks), Master Effect x 9 types (Preset settings for parameters of each effect type are provided as templates; total 320) Master EQ (5 bands), Part EQ (3 bands, stereo)	
	<b>Sampling block</b>	Samples	Up to 128 Waveforms (Multi Samples) Up to 256 Key Banks per Waveform Up to 512 Key Banks
		Sampling Sources	Analog input L/R, Stereo output (Resampling) FW (available when the FW16E has been installed)
A/D Conversion		24-bit, 64x oversampling	
D/A Conversion		24-bit, 128x oversampling	
Sample Data Bits		16	
Sampling Frequency		44.1kHz, 22.05kHz, 11.025kHz, 5.5125kHz (Stereo/Mono) Sampling Frequency via FW (when the FW16E has been installed): 44.1kHz (fixed)	
Sampling Memory		Internal SDRAM: 128M	
Sample Length		Mono: 32 MB Stereo: 64 MB	
Sampling Time		44.1kHz: 6 min. 20 sec. 22.05kHz: 12 min. 40 sec. 11.025kHz: 25 min. 20 sec. 5.5125kHz: 55 min. 40 sec. *Mono/Stereo	
Sample Format		Original format, WAV, AIFF	
Sampling Sources	Analog input L/R, Stereo output (Resampling) FW (available when the FW16E has been installed)		
<b>Sequencer block</b>	Note Capacity	Approx. 130,000 notes	
	Note Resolution	480 ppq (parts per quarter note)	
	Maximum Polyphony	124 notes	
	Tempo (BPM)	5 – 300	
	Recording type	Real time replace Real time overdub (with the exception of the Pattern Chain) Real time punch in/out (Song only)	
	Tracks	Pattern: 16 Phrase tracks Pattern Chain: Pattern track, Tempo track, Scene track Song: 16 sequence tracks (Loop on/off can be set for each track), Tempo track, Scene track	
	Patterns	64 Patterns (x 16 sections), Measures: 256 maximum Mixing Voices: 16 Voices per Pattern and up to 256 Voices for all Patterns Mixing Templates: 32 for all Songs and Patterns	
	Phrases	User Phrases: 256 per Pattern	
	Songs	64 Songs Mixing Voices: 16 Voices per Song and up to 256 Voices for all Songs Mixing Templates: 32 for all Songs and Patterns	

<b>Sequencer block</b>	Arpeggio	Preset: 7,881 types User: 256 types *MIDI Sync, MIDI transmit/receive channel, Velocity Limit, and Note Limit can be set.
	Scene Memory	5 per Song
	Sequence Format	Original format, SMF format 0, 1 (Format 1 load only)
<b>Others</b>	Master	User: 128 *8 Zones (Master keyboard settings), Assignable Knob/Slider settings, Program Change Table
	Sequence Software compatible with the Remote Control function	For Windows <sup>®</sup> : Cubase 4 – 5, SONAR 5.2 – 8 For Mac <sup>®</sup> : Cubase 4 – 5, Logic 7.2 – LogicStudio, Digital Performer 5.1 – 6 *Functions to be controlled differ depending on the software.
	Controllers	Pitch Bend wheel, Modulation wheel, Ribbon Controller, Assignable Control Sliders x 8, Assignable Knobs x 8, Assignable Function buttons x 2, Data dial
	Display	320 x 240 dot, 5.7 inch graphic color backlit LCD
	Connectors	OUTPUT L/MONO, R (standard phone jack) ASSIGNABLE OUTPUT L, R (standard phone jack) A/D INPUT L, R (standard phone jack) DIGITAL OUT PHONES (standard stereo phone jack) FOOT CONTROLLER 1, 2 FOOT SWITCH x 2 (SUSTAIN, ASSIGNABLE) MIDI IN/OUT/THRU USB (TO HOST, TO DEVICE) AC IN ETHERNET (100BASE-TX) IEEE1394 (available when the FW16E has been installed)
	Power Consumption	30W
	Dimensions, Weight	MOTIF XF8: 1,439 (W) x 466 (D) x 168 (H) mm, 28.9 kg MOTIF XF7: 1,252 (W) x 391 (D) x 122 (H) mm, 17.2 kg MOTIF XF6: 1,045 (W) x 391 (D) x 122 (H) mm, 15.1 kg
	Accessories	AC Power cord, Owner's Manual (this book), Owner's Manual CD-ROM (containing Reference Manual and Data List), DVD-ROM (containing DAW software)

\*Specifications and descriptions in this owner's manual are for information purposes only. Yamaha Corp. reserves the right to change or modify products or specifications at any time without prior notice. Since specifications, equipment or options may not be the same in every locale, please check with your Yamaha dealer.

### Note on source code distribution

For three years after the final factory shipment, you may request from Yamaha the source code for any portions of the product which are licensed under the GNU General Public License by writing to the following address:

DE Group Marketing Department Digital Musical Instruments Division,  
YAMAHA Corporation  
10-1 Nakazawa-cho, Naka-ku, Hamamatsu, 430-8650, JAPAN

- The source code will be provided at no charge; however, we may require you to reimburse Yamaha for the cost of delivering the source code to you.
- Note that we shall bear no responsibility whatsoever for any damage arising from changes (additions/ deletions) made to the software for this product by a third party other than Yamaha (or party authorized by Yamaha).
- Note that re-use of source code released to the public domain by Yamaha is unguaranteed, and Yamaha shall not bear any responsibility whatsoever for the source code.
- The source code can be downloaded from the following address:  
<http://www.yamahasyth.com/download/source/motifxf>
- About GNU General Public License, refer to the separate Data List (PDF file).

# Index

## A

A/D INPUT jacks .....	15, 47
AC IN .....	14
Arpeggio .....	23
[ARPEGGIO ON/OFF] button .....	11
Arpeggio tempo .....	24
Arpeggio type .....	24
ASSIGNABLE FUNCTION button .....	10
ASSIGNABLE OUT L and R jacks .....	15
Audio Record/Playback .....	33
Auto Load .....	54

## B

Bank buttons .....	12, 22
--------------------	--------

## C

Category Search .....	23
[CATEGORY SEARCH] button .....	13, 23
CHAR .....	20
Click .....	31, 32
[COMMON EDIT] button .....	13
Compatible USB devices .....	65
Computer .....	56
Control Sliders .....	11
Controllers .....	25
Convert to Song .....	45
Copy Performance Parameters .....	31, 32
Copy to Flash Memory .....	53
Cubase .....	62
Cursor buttons .....	12, 19

## D

Data dial .....	12, 19
Data List .....	6
DAW .....	56
[DEC/NO] button .....	12, 19
Demo Pattern .....	41
Demo Song .....	17
DIGITAL OUT connector .....	14
Digital Performer .....	62
Drum Voice Edit .....	26
Drum Voices .....	22

## E

Edit indicator .....	26
EFFECT buttons .....	11
Effects .....	27
Element .....	26
End Point .....	50
[ENTER] button .....	12
ETHERNET connector .....	14
[EXIT] button .....	12

## F

[F1] – [F6] (Function) buttons .....	12, 19
Factory Settings .....	18

[FILE] button .....	21, 64
File mode .....	21, 64
FireWire expansion board (FW16E) cover .....	14
FL512M/FL1024M .....	74, 76
Flash Memory Expansion Module .....	47
FOOT CONTROLLER jacks .....	15
FOOT SWITCH jacks .....	15
Functions of the Number [1] – [16] buttons .....	13
FW Audio Channels .....	59
FW16E .....	74, 75

## G

GAIN knob .....	15, 47, 50
GM Bank .....	22
GM Voice .....	22
Group [A] – [H] buttons .....	12

## H

Headphones .....	16
------------------	----

## I

IEEE1394 terminal .....	57
[INC/YES] button .....	12, 19
Input Source .....	48
[INTEGRATED SAMPLING] button .....	21

## K

KBD .....	20
Key On Start Switch .....	31, 32
Keybank .....	48
Keyboard .....	10
Knobs .....	10, 25

## L

Layer .....	28, 29
LCD Contrast Control .....	14, 17
LCD Display .....	12
LIST .....	20
Load .....	64
Logic Pro .....	62

## M

[MASTER] button .....	21, 35
[MASTER EFFECT] button .....	12
Master Keyboard .....	35
Master mode .....	21, 35
MASTER VOLUME .....	10
MIDI channel .....	57
MIDI IN/OUT/THRU connectors .....	14
MIDI port .....	57
Mixing .....	37
[MIXING] button .....	21, 46
Mixing mode .....	21, 46
Mode .....	21
MODE buttons .....	12, 21
Modulation wheel .....	10



- MOTIF XF Editor VST ..... 63  
[MULTI PART CONTROL] button ..... 11  
Multi-timbral Tone Generator ..... 46  
[MUTE] button ..... 13, 37
- N**
- Naming ..... 20  
Normal Voice Edit ..... 26  
Normal Voices ..... 22  
NUM ..... 19  
Number [1] – [16] buttons ..... 12  
    Function chart ..... 13
- O**
- OCTAVE [UP] and [DOWN] buttons ..... 12  
OUTPUT L/MONO and R jacks ..... 15
- P**
- Part ..... 48  
Pattern ..... 41  
[PATTERN] button ..... 21, 41  
Pattern Chain ..... 43  
Pattern mode ..... 21, 41  
Pattern number ..... 32  
[PERFORM] button ..... 21, 28  
Performance ..... 28  
[PERFORMANCE CONTROL] button ..... 13  
Performance mode ..... 21, 28  
PHONES (Headphone) jack ..... 15  
Phrase ..... 42  
Pitch Bend wheel ..... 10  
Play Effect ..... 40  
Power On Mode ..... 54  
Power switch ..... 14  
Preset Banks ..... 22  
[PROGRAM] button ..... 13  
Punch In/Out ..... 52
- R**
- Realtime Recording ..... 37  
Record (Pattern) ..... 42  
Record (Performance) ..... 31  
Record (Sampling) ..... 47  
Record (Song) ..... 38  
Record Next ..... 48, 50, 52  
Recording Type ..... 48, 50, 52  
Reference Manual ..... 6  
Remote mode ..... 61  
[REMOTE ON/OFF] button ..... 11  
Ribbon Controller ..... 10
- S**
- Sample ..... 47  
Sampling ..... 47  
Sampling mode ..... 21  
Save ..... 64  
Screen Setting ..... 54  
Section ..... 41  
Section Length ..... 32  
[SELECTED PART CONTROL] button ..... 10, 25  
SEQ TRANSPORT buttons ..... 12  
Sequencer Mode ..... 31, 32  
[SF1] – [SF5] (Sub Function) buttons ..... 12, 19  
Slice ..... 51  
[SOLO] button ..... 13, 37  
SONAR ..... 62  
Song ..... 37  
[SONG] button ..... 21  
Song mode ..... 21  
Song number ..... 31  
Specifications ..... 78  
Split ..... 29  
Store  
    Master ..... 36  
    Pattern ..... 43  
    Performance ..... 30  
    Song ..... 40  
    Utility ..... 54  
    Voice ..... 27
- T**
- TAP ..... 24  
Tempo ..... 24  
Time Signature ..... 31, 32  
Track ..... 37  
[TRACK] button ..... 13  
Track mute ..... 37  
Track solo ..... 37  
Transpose ..... 55  
Trigger Mode ..... 48, 50, 52  
Troubleshooting ..... 68  
Tuning ..... 55
- U**
- USB connectors ..... 14  
USB storage devices ..... 65  
USB TO DEVICE terminal ..... 65  
USB TO HOST terminal ..... 56  
USB-MIDI Driver ..... 56  
User Banks ..... 22  
[UTILITY] button ..... 21, 54  
Utility mode ..... 21, 54
- V**
- [VOICE] button ..... 21  
Voice mode ..... 21, 22
- W**
- Waveform ..... 53
- Y**
- Yamaha Steinberg FW Driver ..... 57
- Z**
- Zone ..... 35

## FCC INFORMATION (U.S.A.)

### 1. IMPORTANT NOTICE: DO NOT MODIFY THIS UNIT!

This product, when installed as indicated in the instructions contained in this manual, meets FCC requirements. Modifications not expressly approved by Yamaha may void your authority, granted by the FCC, to use the product.

### 2. IMPORTANT:

When connecting this product to accessories and/or another product use only high quality shielded cables. Cable/s supplied with this product MUST be used. Follow all installation instructions. Failure to follow instructions could void your FCC authorization to use this product in the USA.

### 3. NOTE:

This product has been tested and found to comply with the requirements listed in FCC Regulations, Part 15 for Class "B" digital devices. Compliance with these requirements provides a reasonable level of assurance that your use of this product in a residential environment will not result in harmful interference with other electronic devices. This equipment generates/uses radio frequencies and, if not installed and used according to the instructions found in the users manual, may cause interference harmful to the operation of other electronic devices. Compliance with FCC regulations does

not guarantee that interference will not occur in all installations. If this product is found to be the source of interference, which can be determined by turning the unit "OFF" and "ON", please try to eliminate the problem by using one of the following measures:

Relocate either this product or the device that is being affected by the interference.

Utilize power outlets that are on different branch (circuit breaker or fuse) circuits or install AC line filter/s.

In the case of radio or TV interference, relocate/reorient the antenna. If the antenna lead-in is 300 ohm ribbon lead, change the lead-in to co-axial type cable.

If these corrective measures do not produce satisfactory results, please contact the local retailer authorized to distribute this type of product. If you can not locate the appropriate retailer, please contact Yamaha Corporation of America, Electronic Service Division, 6600 Orangethorpe Ave, Buena Park, CA90620

The above statements apply ONLY to those products distributed by Yamaha Corporation of America or its subsidiaries.

\* This applies only to products distributed by YAMAHA CORPORATION OF AMERICA.

(class B)

### COMPLIANCE INFORMATION STATEMENT (DECLARATION OF CONFORMITY PROCEDURE)

Responsible Party : Yamaha Corporation of America  
Address : 6600 Orangethorpe Ave., Buena Park, Calif.  
90620  
Telephone : 714-522-9011  
Type of Equipment : Music Production Synthesizer  
Model Name : MOTIF XF6, MOTIF XF7, MOTIF XF8

This device complies with Part 15 of the FCC Rules.

Operation is subject to the following two conditions:

- 1) this device may not cause harmful interference, and
- 2) this device must accept any interference received including interference that may cause undesired operation.

See user manual instructions if interference to radio reception is suspected.

\* This applies only to products distributed by  
YAMAHA CORPORATION OF AMERICA.

(FCC DoC)

### IMPORTANT NOTICE FOR THE UNITED KINGDOM

#### Connecting the Plug and Cord

**WARNING:** THIS APPARATUS MUST BE EARTHED IMPORTANT. The wires in this mains lead are coloured in accordance with the following code:

GREEN-AND-YELLOW	: EARTH
BLUE	: NEUTRAL
BROWN	: LIVE

As the colours of the wires in the mains lead of this apparatus may not correspond with the coloured markings identifying the terminals in your plug proceed as follows:

The wire which is coloured GREEN-and-YELLOW must be connected to the terminal in the plug which is marked by the letter E or by the safety earth symbol  $\oplus$  or colored GREEN or GREEN-and-YELLOW.

The wire which is coloured BLUE must be connected to the terminal which is marked with the letter N or coloured BLACK.

The wire which is coloured BROWN must be connected to the terminal which is marked with the letter L or coloured RED.

\* This applies only to products distributed by Yamaha Music U.K. Ltd.

(3 wires)

This product contains a high intensity lamp that contains a small amount of mercury. Disposal of this material may be regulated due to environmental considerations.

For disposal information in the United States, refer to the Electronic Industries Alliance web site:

[www.eiae.org](http://www.eiae.org)

\* This applies only to products distributed by  
YAMAHA CORPORATION OF AMERICA.

(mercury)

The serial number of this product may be found on the rear of the unit. You should note this serial number in the space provided below and retain this manual as a permanent record of your purchase to aid identification in the event of theft.

**Model No.**

---

**Serial No.**

---

(rear)

# Important Notice: Guarantee Information for customers in EEA\* and Switzerland (EEA) and Switzerland

<b>English</b>	<b>Important Notice: Guarantee Information for customers in EEA* and Switzerland</b> For detailed guarantee information about this Yamaha product, and Pan-EEA* and Switzerland warranty service, please either visit the website address below (Printable file is available at our website) or contact the Yamaha representative office for your country (next page). * EEA: European Economic Area
<b>Deutsch</b>	<b>Wichtiger Hinweis: Garantie-Information für Kunden im EWR* und in der Schweiz</b> Für nähere Garantie-Information über dieses Produkt von Yamaha, sowie über den Pan-EWR*- und Schweizer Garantieservice, besuchen Sie bitte entweder die folgende angegebene Internetadresse (eine druckfähige Version befindet sich auch auf unserer Webseite), oder wenden Sie sich an den für Ihr Land zuständigen Yamaha-Vertrieb (nächste Seite). *EWR: Europäischer Wirtschaftsraum
<b>Français</b>	<b>Remarque importante: informations de garantie pour les clients de l'EEE et la Suisse</b> Pour des informations plus détaillées sur la garantie de ce produit Yamaha et sur le service de garantie applicable dans l'ensemble de l'EEE ainsi qu'en Suisse, consultez notre site Web à l'adresse ci-dessous (le fichier imprimable est disponible sur notre site Web) ou contactez directement Yamaha dans votre pays de résidence (page suivante). * EEE : Espace Economique Européen
<b>Nederlands</b>	<b>Belangrijke mededeling: Garantie-informatie voor klanten in de EER* en Zwitserland</b> Voor gedetailleerde garantie-informatie over dit Yamaha-product en de garantieservice in heel de EER* en Zwitserland, gaat u naar de onderstaande website (u vind een afdrukbaar bestand op onze website) of neemt u contact op met de vertegenwoordiging van Yamaha in uw land (volgende pagina). * EER: Europese Economische Ruimte
<b>Español</b>	<b>Aviso importante: información sobre la garantía para los clientes del EEE* y Suiza</b> Para una información detallada sobre este producto Yamaha y sobre el soporte de garantía en la zona EEE* y Suiza, visite la dirección web que se incluye más abajo (la versión del archivo para imprimir está disponible en nuestro sitio web) o póngase en contacto con el representante de Yamaha en su país (página siguiente). * EEE: Espacio Económico Europeo
<b>Italiano</b>	<b>Aviso importante: informazioni sulla garanzia per i clienti residenti nell'EEA* e in Svizzera</b> Per informazioni dettagliate sulla garanzia relativa a questo prodotto Yamaha e l'assistenza in garanzia in EEA* e in Svizzera, potete consultare il sito Web all'indirizzo riportato di seguito (è disponibile il file in formato stampabile) oppure contattate l'ufficio di rappresentanza locale della Yamaha (pagina seguente). * EEA: Area Economica Europea
<b>Português</b>	<b>Aviso importante: informações sobre as garantias para clientes da AEE* e da Suíça</b> Para obter uma informação pormenorizada sobre este produto da Yamaha e sobre o serviço de garantia na AEE* e na Suíça, visite o site a seguir (o arquivo para impressão está disponível no nosso site) ou entre em contato com o escritório de representação da Yamaha no seu país (próxima página). * AEE: Área Económica Europeia
<b>Ελληνικά</b>	<b>Σημαντική σημείωση: Πληροφορίες εγγύησης για τους πελάτες στον ΕΟΧ* και Ελβετία</b> Για λεπτομερές πληροφοριακό έγγραφο σχετικά με το προϊόν της Yamaha και την κάλυψη εγγύησης σε όλη τις χώρες του ΕΟΧ και την Ελβετία, επισκεφτείτε την παρακάτω ιστοσελίδα (Εκτυπώσιμη μορφή είναι διαθέσιμη στην ιστοσελίδα μας) ή απευθυνθείτε στην αντιπροσωπεία της Yamaha στη χώρα σας (επόμενη σελίδα). * ΕΟΧ: Ευρωπαϊκός Οικονομικός Χώρος
<b>Svenska</b>	<b>Viktigt: Garantiinformation för kunder i EES-området* och Schweiz</b> För detaljerad information om denna Yamaha-produkt samt garantireservice i hela EES-området* och Schweiz kan du antingen besöka nedanstående webbadress (en utskriftsvänlig fil finns på webbplatsen) eller kontakta Yamahas officiella representant i ditt land (nästa sida). * EES: Europeiska Ekonomiska Samarbetsområdet
<b>Norsk</b>	<b>Viktig merknad: Garantiinformasjon for kunder i EØS* og Sveits</b> Detaljeret garantiinformasjon om dette Yamaha-produktet og garantireservice for hele EØS-området* og Sveits kan fås enten ved å besøke nettstedene nedenfor (utskriftsversjon finnes på våre nettsider) eller kontakte kontakte Yamaha-kontoret i landet der du bor (neste side). *EØS: Det europeiske økonomiske samarbeidsområdet
<b>Dansk</b>	<b>Vigtig oplysning: Garantioplysninger til kunder i EØO* og Schweiz</b> De kan finde detaljerede garantioplysninger om dette Yamaha-produkt og den fælles garantireserviceordning for EØO* (og Schweiz) ved at besøge det websted, der er angivet nedenfor (der findes en fil, som kan udskrives, på vores websted), eller ved at kontakte Yamahas nationale repræsentationskontor i det land, hvor De bor (næste side). * EØO: Det Europæiske Økonomiske Område

<b>Suomi</b>	<b>Tärkeä ilmoitus: Takuudotet Euroopan talousalueen (ETA)* ja Sveitsin asiakkaille</b> Tämän Yamaha-tuotteen sekä ETA-alueen ja Sveitsin takuuta koskevat yksityiskohtaiset tiedot saatte alla olevasta netti-sivustalta. (Tulostettava tiedosto saatavana sivustollamme.) Voitte myös ottaa yhteyttä paikalliseen Yamaha-edustajaan (seuraavalla sivulla). *ETA: Euroopan talousalue
<b>Polski</b>	<b>Ważne: Warunki gwarancyjne obowiązujące w EOG* i Szwajcarii</b> Aby dowiedzieć się więcej na temat warunków gwarancyjnych tego produktu firmy Yamaha i serwisu gwarancyjnego w całym EOG* i Szwajcarii, należy odwiedzić wskazaną poniżej stronę internetową (Plik gotowy do wydruku znajduje się na naszej stronie internetowej) lub skontaktować się z przedstawicielstwem firmy Yamaha w swoim kraju (następna strona). * EOG — Europejski Obszar Gospodarczy
<b>Česky</b>	<b>Důležité oznámení: Záruční informace pro zákazníky v EHS* a ve Švýcarsku</b> Podrobné záruční informace o tomto produktu Yamaha a záručním servisu v celém EHS* a ve Švýcarsku naleznete na níže uvedené webové adrese (soubor k tisku je dostupný na našich webových stránkách) nebo se můžete obrátit na zástupce firmy Yamaha ve své zemi (další stránka). * EHS: Evropský hospodářský prostor
<b>Magyar</b>	<b>Fontos figyelmeztetés: Garancia-információk az EGT* területén és Svájcban élő vásárlók számára</b> A jelen Yamaha termékre vonatkozó részletes garancia-információk, valamint az EGT*-re és Svájcra kiterjedő garanciális szolgáltatás tekintetében keressék fel webhelyünket az alábbi címen (a webhelyen nyomtatható fájl is található), vagy pedig lépjen kapcsolatba az országában működő Yamaha képviselői irodával (következő oldal). * EGT: Európai Gazdasági Térség
<b>Eesti keel</b>	<b>Oluline märkus: Garantiteave Euroopa Majanduspiirkonna (EMP)* ja Šveitsi klientidele</b> Täpsema teabe saamiseks selle Yamaha toote garantii ning kogu Euroopa Majanduspiirkonna ja Šveitsi garantiteeninduse kohta, külastage palun veebisaiti, alljärgnevat aadressi (meie saidil on saadaval printitav fail) või pöörduge Teie regiooni Yamaha esinduse poole (järgmine lehekülg). * EMP: Euroopa Majanduspiirkond
<b>Latviešu</b>	<b>Svarīgs paziņojums: garantijas informācija klientiem EEZ* un Šveicē</b> Lai saņemtu detalizētu garantijas informāciju par šo Yamaha produktu, kā arī garantijas apkalpošanu EEZ* un Šveicē, lūdzu, apmeklējiet zemāk norādīto tīmekļa vietnes adresi (tīmekļa vietnē ir pieejams drukājams fails) vai sazinieties ar jūsu valstī apkalpojošo Yamaha pārstāvniecību (nākamā lappuse). * EEZ: Eiropas Ekonomikas zona
<b>Lietuvių kalba</b>	<b>Dėmesio: informacija dėl garantijos priekėjams EEE* ir Šveicarijose</b> Jei reikia išsamios informacijos apie šį „Yamaha“ produktą ir jo techninę priežiūrą visoje EEE* ir Šveicarijose, apsilankykite mūsų svetainėje toliau nurodytu adresu (svetainėje yra spausdinamas failas) arba kreipkitės į „Yamaha“ atstovą savo šaliai (kitas puslapis). *EEE – Europos ekonominė erdvė
<b>Slovenčina</b>	<b>Dôležité upozornenie: Informácie o záruke pre zákazníkov v EHP* a Švajčiarsku</b> Podrobné informácie o záruke týkajúce sa tohto produktu od spoločnosti Yamaha a garancijnom servise v EHP* a Švajčiarsku nájdete na webovej stránke uvedenej nižšie (na našej webovej stránke je k dispozícii súbor na tlač) alebo sa obráťte na zástupcu spoločnosti Yamaha vo svojej krajine (nasledujúca stránka). * EHP: Európsky hospodársky priestor
<b>Slovenščina</b>	<b>Pomembno obvestilo: Informacije o garanciji za kupce v EGP* in Švici</b> Za podrobnejše informacije o tem Yamahinem izdelku ter garancijskem servisu v celotnem EGP in Švici, obiščite spletno mesto, ki je navedeno spodaj (natisljiva datoteka je na voljo na našem spletnem mestu), ali se obrnite na Yamahinega predstavnik v svoji državi (naslednja stran). * EGP: Evropski gospodarski prostor
<b>Български език</b>	<b>Важно съобщение: Информация за гаранцията за клиенти в ЕИП* и Швейцария</b> За подробна информация за гаранцията за този продукт на Yamaha и гаранционното обслужване в паневропейската зона на ЕИП* и Швейцария или посетете посочения по-долу уеб сайт (на нашия уеб сайт има файл за печат), или се свържете с представителния офис на Yamaha във вашата страна (следваща страница). * ЕИП: Европейско икономическо пространство
<b>Limba română</b>	<b>Notificare importantă: Informații despre garanție pentru clienții din SEE* și Elveția</b> Pentru informații detaliate privind acest produs Yamaha și serviciul de garanție Pan-SEE* și Elveția, vizitați site-ul la adresa de mai jos (fișierul imprimabil este disponibil pe site-ul nostru) sau contactați biroul reprezentanței Yamaha din țara dumneavoastră (pagina următoare). * SEE: Spațiul Economic European

<http://europe.yamaha.com/warranty/>

# Yamaha Representative Offices in Europe

## AUSTRIA

Yamaha Music Europe GmbH  
Branch Austria  
Schleiergasse 20, A-1100 Wien Austria  
Tel: +43 (0)1 602 03900  
Fax: +43 (0)1 602 039051

## BELGIUM

Yamaha Music Europe  
Branch Benelux  
Clarissenhof 5b NL, 4133 AB. Vianen  
The Netherlands  
Tel: +31 (0)347 358040  
Fax: +31 (0)347 358060

## BULGARIA

Yamaha Music Europe GmbH  
Branch Austria (Central and Eastern Europe)  
Schleiergasse 20, A-1100 Wien Austria  
Tel: +43 (0)1 602 03900  
Fax: +43 (0)1 602 039051

## CYPRUS

NAKAS Music Cyprus Ltd.  
31C Nikis Ave., 1086 Nicosia  
Tel: +357 (0)22 510 477  
Fax: +357 (0)22 511 080

## CZECH REPUBLIC

Yamaha Music Europe GmbH  
Branch Austria (Central and Eastern Europe)  
Schleiergasse 20, A-1100 Wien Austria  
Tel: +43 (0)1 602 03900  
Fax: +43 (0)1 602 039051

## DENMARK

YS Copenhagen Liaison Office  
(Yamaha Scandinavia AB Filial Denmark)  
Generatorvej 6A, 2730 Herlev, Denmark  
Tel: +45 44 92 49 00  
Fax: +45 44 54 47 09

## ESTONIA

Yamaha Music Europe GmbH  
Sp. z o.o. Oddział w Polsce  
(Branch Poland)  
ul. 17 Stycznia 56  
PL-02-146 Warszawa Poland  
Tel: +48 (0)22 500 29 25  
Fax: +48 (0)22 500 29 30

## FINLAND

F - Musiikki OY  
Kaisaniemenkatu 7, PL260  
00101 Helsinki, Finland  
Tel: +358 (0)9 618511  
Fax: +358 (0)9 61851385

(For Pro Audio)

Yamaha Scandinavia AB  
J.A. Wettergrens gata 1  
Västra Frölunda, Sweden  
(Box 300 53, 400 43 Göteborg  
Sweden - Postal Address)  
Tel: +46 (0)31 893400  
Fax: +46 (0)31 454026

## FRANCE

Yamaha Musique France  
Zone d'activité de Pariest  
7, rue Ambroise Croizat  
77183 Croissy-Beaubourg, France  
(B.P. 70, 77312 Mame la Vallée Cedex 2  
France-Adresse postale)  
Tel: +33 (0)1 64 61 4000  
Fax: +33 (0)1 64 61 4079

## GERMANY

Yamaha Music Europe GmbH  
Siemensstr. 22-34  
D-25462 Rellingen, b. Hamburg, Germany  
Tel: +49 (0)4101 3030  
Fax: +49 (0)4101 303 77702

## GREECE

PH. Nakas S.A. Music House/Service  
19 KM Leoforos Lavriou  
19002 Peania / Attiki, Greece  
Tel: +30 (0)210 6686260  
Fax: +30 (0)210 6686269

## HUNGARY

Yamaha Music Europe GmbH  
Branch Austria (Central and Eastern Europe)  
Schleiergasse 20, A-1100 Wien Austria  
Tel: +43 (0)1 602 03900  
Fax: +43 (0)1 602 039051

## ICELAND

(For Musical Instrument)  
HLJODFAERAHUSID EHF  
Sidumula 20  
108 Reykjavik, Iceland  
Tel: +354 525 50 50  
Fax: +354 568 65 14

(For Pro Audio)

Yamaha Scandinavia AB  
J.A. Wettergrens gata 1  
Västra Frölunda, Sweden  
(Box 300 53, 400 43 Göteborg  
Sweden - Postal Address)  
Tel: +46 (0)31 893400  
Fax: +46 (0)31 454026

## IRELAND (REPUBLIC OF IRELAND)

Yamaha Music UK Ltd.  
Sherbourne Drive  
Tilbrook, Milton Keynes MK7 8BL  
United Kingdom  
Tel: +353 (0) 1526 2449  
Fax: +44 (0) 1908 369278

## ITALY

Yamaha Musica Italia s.p.a.  
Viale Italia 88  
20020, Lainate (Milano), Italy  
Tel: +39 (0)02 93577 1  
Fax: +39 (0)02 937 0956

## LATVIA

Yamaha Music Europe GmbH  
Sp. z o.o. Oddział w Polsce  
(Branch Poland)  
ul. 17 Stycznia 56  
PL-02-146 Warszawa Poland  
Tel: +48 (0)22 500 29 25  
Fax: +48 (0)22 500 29 30

## LIECHTENSTEIN

Yamaha Music Europe GmbH, Rellingen,  
Branch Switzerland in Zurich  
Seefeldstrasse 94, CH-8008  
Zürich, Switzerland  
Tel: +41 (0)44 3878080  
Fax: +41 (0)44 3833918

## LITHUANIA

Yamaha Music Europe GmbH  
Sp. z o.o. Oddział w Polsce  
(Branch Poland)  
ul. 17 Stycznia 56  
PL-02-146 Warszawa Poland  
Tel: +48 (0)22 500 29 25  
Fax: +48 (0)22 500 29 30

## LUXEMBOURG

Yamaha Music Europe  
Branch Benelux  
Clarissenhof 5b NL, 4133 AB. Vianen  
The Netherlands  
Tel: +31 (0)347 358040  
Fax: +31 (0)347 358060

## MALTA

Olimpus Music Ltd.  
The Emporium, Level 3, St. Louis Street  
Msida MSD06  
Tel: +356 (0)2133 2093  
Fax: +356 (0)2133 2144

## NETHERLANDS

Yamaha Music Europe  
Branch Benelux  
Clarissenhof 5b NL, 4133 AB. Vianen  
The Netherlands  
Tel: +31 (0)347 358040  
Fax: +31 (0)347 358060

## NORWAY

YS Oslo Liaison Office  
(Yamaha Scandinavia AB Filial Norway)  
Grini Naeringspark 1  
1361 Osteras, Norway  
Tel: +47 67 16 77 70  
Fax: +47 67 16 77 79

## POLAND

YAMAHA Music Europe GmbH  
Sp. z o.o. Oddział w Polsce  
ul. 17 Stycznia 56  
02-146 WARSZAWA/POLSKA  
Tel: +48 (0)22 500 29 25  
Fax: +48 (0)22 500 29 30

## PORTUGAL

Yamaha Música Ibérica, S.A.U.  
Sucursal Portuguesa  
Rua Alfredo da Silva  
2610-016 Amadora, Portugal  
Tel: +351 214 704 330  
Fax: +351 214 718 220

## ROMANIA

Yamaha Music Europe GmbH  
Branch Austria (Central and Eastern Europe)  
Schleiergasse 20, A-1100 Wien Austria  
Tel: +43 (0)1 602 03900  
Fax: +43 (0)1 602 039051

## SLOVAKIA

Yamaha Music Europe GmbH  
Branch Austria (Central and Eastern Europe)  
Schleiergasse 20, A-1100 Wien Austria  
Tel: +43 (0)1 602 03900  
Fax: +43 (0)1 602 039051

## SLOVENIA

Yamaha Music Europe GmbH  
Branch Austria (Central and Eastern Europe)  
Schleiergasse 20, A-1100 Wien Austria  
Tel: +43 (0)1 602 03900  
Fax: +43 (0)1 602 039051

## SPAIN

Yamaha Musica Ibérica, S.A.U.  
Ctra. de la Coruna km.17, 200  
28230 Las Rozas de Madrid, Spain  
Tel: +34 902 39 8888  
Fax: +34 91 638 4660

## SWEDEN

Yamaha Scandinavia AB  
J.A. Wettergrens gata 1  
Västra Frölunda, Sweden  
(Box 300 53, 400 43 Göteborg  
Sweden - Postal Address)  
Tel: +46 (0)31 893400  
Fax: +46 (0)31 454026

## SWITZERLAND

Yamaha Music Europe GmbH, Rellingen,  
Branch Switzerland in Zurich  
Seefeldstrasse 94, CH-8008  
Zürich, Switzerland  
Tel: +41 (0)44 3878080  
Fax: +41 (0)44 3833918

## UNITED KINGDOM

Yamaha Music UK Ltd.  
Sherbourne Drive  
Tilbrook, Milton Keynes MK7 8BL  
United Kingdom  
Tel: +44 (0) 870 4445575  
Fax: +44 (0) 1908 369278

For details of products, please contact your nearest Yamaha representative or the authorized distributor listed below.

Pour plus de détails sur les produits, veuillez-vous adresser à Yamaha ou au distributeur le plus proche de vous figurant dans la liste suivante.

Die Einzelheiten zu Produkten sind bei Ihrer unten aufgeführten Niederlassung und bei Yamaha Vertragshändlern in den jeweiligen Bestimmungsländern erhältlich.

Para detalles sobre productos, contacte su tienda Yamaha más cercana o el distribuidor autorizado que se lista debajo.

## NORTH AMERICA

### CANADA

**Yamaha Canada Music Ltd.**  
135 Milner Avenue, Scarborough, Ontario,  
M1S 3R1, Canada  
Tel: 416-298-1311

### U.S.A.

**Yamaha Corporation of America**  
6600 Orangethorpe Ave., Buena Park, Calif. 90620,  
U.S.A.  
Tel: 714-522-9011

## CENTRAL & SOUTH AMERICA

### MEXICO

**Yamaha de México S.A. de C.V.**  
Calz. Javier Rojo Gómez #1149,  
Col. Guadalupe del Moral  
C.P. 09300, México, D.F., México  
Tel: 55-5804-0600

### BRAZIL

**Yamaha Musical do Brasil Ltda.**  
Rua Joaquim Floriano, 913 - 4º andar, Itaim Bibi,  
CEP 04534-013 Sao Paulo, SP. BRAZIL  
Tel: 011-3704-1377

### ARGENTINA

**Yamaha Music Latin America, S.A.**  
**Sucursal de Argentina**  
Olga Cossetini 1553, Piso 4 Norte  
Madero Este-C1107CEK  
Buenos Aires, Argentina  
Tel: 011-4119-7000

### PANAMA AND OTHER LATIN AMERICAN COUNTRIES/ CARIBBEAN COUNTRIES

**Yamaha Music Latin America, S.A.**  
Torre Banco General, Piso 7, Urbanización Marbella,  
Calle 47 y Aquilino de la Guardia,  
Ciudad de Panamá, Panamá  
Tel: +507-269-5311

## EUROPE

### THE UNITED KINGDOM/IRELAND

**Yamaha Music U.K. Ltd.**  
Sherbourne Drive, Tilbrook, Milton Keynes,  
MK7 8BL, England  
Tel: 01908-366700

### GERMANY

**Yamaha Music Europe GmbH**  
Siemensstraße 22-34, 25462 Rellingen, Germany  
Tel: 04101-3030

### SWITZERLAND/LIECHTENSTEIN

**Yamaha Music Europe GmbH**  
**Branch Switzerland in Zürich**  
Seefeldstrasse 94, 8008 Zürich, Switzerland  
Tel: 01-383 3990

### AUSTRIA

**Yamaha Music Europe GmbH Branch Austria**  
Schleiergasse 20, A-1100 Wien, Austria  
Tel: 01-60203900

### CZECH REPUBLIC/SLOVAKIA/ HUNGARY/SLOVENIA

**Yamaha Music Europe GmbH Branch Austria**  
Schleiergasse 20, A-1100 Wien, Austria  
Tel: 01-602039025

### POLAND/LITHUANIA/LATVIA/ESTONIA

**Yamaha Music Europe GmbH**  
**Branch Sp.z o.o. Oddział w Polsce**  
ul. 17 Stycznia 56, PL-02-146 Warszawa, Poland  
Tel: 022-500-2925

### THE NETHERLANDS/ BELGIUM/LUXEMBOURG

**Yamaha Music Europe Branch Benelux**  
Clarissenhof 5-b, 4133 AB Vianen, The Netherlands  
Tel: 0347-358 040

### FRANCE

**Yamaha Musique France**  
BP 70-77312 Marne-la-Vallée Cedex 2, France  
Tel: 01-64-61-4000

### ITALY

**Yamaha Musica Italia S.P.A.**  
**Combo Division**  
Viale Italia 88, 20020 Lainate (Milano), Italy  
Tel: 02-935-771

### SPAIN/PORTUGAL

**Yamaha Música Ibérica, S.A.**  
Ctra. de la Coruna km. 17, 200, 28230  
Las Rozas (Madrid), Spain  
Tel: 91-639-8888

### GREECE

**Philippos Nakas S.A. The Music House**  
147 Skiathou Street, 112-55 Athens, Greece  
Tel: 01-228 2160

### SWEDEN

**Yamaha Scandinavia AB**  
J. A. Wettergrens Gata 1, Box 30053  
S-400 43 Göteborg, Sweden  
Tel: 031 89 34 00

### DENMARK

**YS Copenhagen Liaison Office**  
Generatorvej 6A, DK-2730 Herlev, Denmark  
Tel: 44 92 49 00

### FINLAND

**F-Musiikki Oy**  
Kluuvikatu 6, P.O. Box 260,  
SF-00101 Helsinki, Finland  
Tel: 09 618511

### NORWAY

**Norsk filial av Yamaha Scandinavia AB**  
Grini Næringspark 1, N-1345 Østerås, Norway  
Tel: 67 16 77 70

### ICELAND

**Skifan HF**  
Skeifan 17 P.O. Box 8120, IS-128 Reykjavik, Iceland  
Tel: 525 5000

### RUSSIA

**Yamaha Music (Russia)**  
Room 37, bld. 7, Kievskaya street, Moscow,  
121059, Russia  
Tel: 495 626 5005

### OTHER EUROPEAN COUNTRIES

**Yamaha Music Europe GmbH**  
Siemensstraße 22-34, 25462 Rellingen, Germany  
Tel: +49-4101-3030

## AFRICA

**Yamaha Corporation,**  
**Asia-Pacific Sales & Marketing Group**  
Nakazawa-cho 10-1, Naka-ku, Hamamatsu,  
Japan 430-8650  
Tel: +81-53-460-2313

## MIDDLE EAST

### TURKEY/CYPRUS

**Yamaha Music Europe GmbH**  
Siemensstraße 22-34, 25462 Rellingen, Germany  
Tel: 04101-3030

### OTHER COUNTRIES

**Yamaha Music Gulf FZE**  
LOB 16-513, P.O.Box 17328, Jubel Ali,  
Dubai, United Arab Emirates  
Tel: +971-4-881-5868

## ASIA

### THE PEOPLE'S REPUBLIC OF CHINA

**Yamaha Music & Electronics (China) Co., Ltd.**  
2F, Yunhedasha, 1818 Xinzha-lu, Jingan-qu,  
Shanghai, China  
Tel: 021-6247-2211

### HONG KONG

**Tom Lee Music Co., Ltd.**  
11/F., Silvercord Tower 1, 30 Canton Road,  
Tsimshatsui, Kowloon, Hong Kong  
Tel: 2737-7688

### INDIA

**Yamaha Music India Pvt. Ltd.**  
5F Ambience Corporate Tower Ambience Mall Complex  
Ambience Island, NH-8, Gurgaon-122001, Haryana, India  
Tel: 0124-466-5551

### INDONESIA

**PT. Yamaha Musik Indonesia (Distributor)**  
**PT. Nusantik**  
Gedung Yamaha Music Center, Jalan Jend. Gatot  
Subroto Kav. 4, Jakarta 12930, Indonesia  
Tel: 021-520-2577

### KOREA

**Yamaha Music Korea Ltd.**  
8F, 9F, Dongsung Bldg. 158-9 Samsung-Dong,  
Kangnam-Gu, Seoul, Korea  
Tel: 02-3467-3300

### MALAYSIA

**Yamaha Music (Malaysia) Sdn., Bhd.**  
Lot 8, Jalan Perbandaran, 47301 Kelana Jaya,  
Petaling Jaya, Selangor, Malaysia  
Tel: 03-78030900

### PHILIPPINES

**Yupangco Music Corporation**  
339 Gil J. Puyat Avenue, P.O. Box 885 MCPO,  
Makati, Metro Manila, Philippines  
Tel: 819-7551

### SINGAPORE

**Yamaha Music (Asia) Pte., Ltd.**  
#03-11 A-Z Building  
140 Paya Lebar Road, Singapore 409015  
Tel: 6747-4374

### TAIWAN

**Yamaha KHS Music Co., Ltd.**  
3F, #6, Sec.2, Nan Jing E. Rd. Taipei.  
Taiwan 104, R.O.C.  
Tel: 02-2511-8688

### THAILAND

**Siam Music Yamaha Co., Ltd.**  
4, 6, 15 and 16th floor, Siam Motors Building,  
891/1 Rama 1 Road, Wangmai,  
Pathumwan, Bangkok 10330, Thailand  
Tel: 02-215-2622

### OTHER ASIAN COUNTRIES

**Yamaha Corporation,**  
**Asia-Pacific Sales & Marketing Group**  
Nakazawa-cho 10-1, Naka-ku, Hamamatsu,  
Japan 430-8650  
Tel: +81-53-460-2313

## OCEANIA

### AUSTRALIA

**Yamaha Music Australia Pty. Ltd.**  
Level 1, 99 Queensbridge Street, Southbank,  
Victoria 3006, Australia  
Tel: 3-9693-5111

### NEW ZEALAND

**Music Works LTD**  
P.O. BOX 6246 Wellesley, Auckland 4680,  
New Zealand  
Tel: 9-634-0099

### COUNTRIES AND TRUST

### TERRITORIES IN PACIFIC OCEAN

**Yamaha Corporation,**  
**Asia-Pacific Sales & Marketing Group**  
Nakazawa-cho 10-1, Naka-ku, Hamamatsu,  
Japan 430-8650  
Tel: +81-53-460-2313

## HEAD OFFICE

**Yamaha Corporation, Digital Musical Instruments Division**  
Nakazawa-cho 10-1, Naka-ku, Hamamatsu, Japan 430-8650  
Tel: +81-53-460-2432



Yamaha Web Site (English)  
<http://www.yamahasynt.com/>  
Yamaha Manual Library  
<http://www.yamaha.co.jp/manual/>