

YAMAHA

PARAMETRIC EQUALIZER

YDP2006

OPERATING MANUAL
MANUEL D'UTILISATION
BEDIENUNGSHANDBUCH

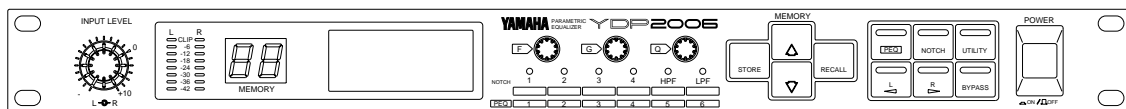

FCC INFORMATION (U.S.A.)

1. **IMPORTANT NOTICE: DO NOT MODIFY THIS UNIT!**

This product, when installed as indicated in the instructions contained in this manual, meets FCC requirements. Modifications not expressly approved by Yamaha may void your authority, granted by the FCC, to use the product.

2. **IMPORTANT:** When connecting this product to accessories and/or another product use only high quality shielded cables. Cable/s supplied with this product **MUST** be used. Follow all installation instructions. Failure to follow instructions could void your FCC authorization to use this product in the USA.

3. **NOTE:** This product has been tested and found to comply with the requirements listed in FCC Regulations, Part 15 for Class "B" digital devices. Compliance with these requirements provides a reasonable level of assurance that your use of this product in a residential environment will not result in harmful interference with other electronic devices. This equipment generates/uses radio frequencies and, if not installed and used according to the instructions found in the users manual, may cause interference harmful to the operation of other electronic devices. Compliance with FCC regulations does not guarantee that interference will not occur in all installations. If this product is found to be the source of interference, which can be determined by turning the unit "OFF" and "ON", please try to eliminate the problem by using one of the following measures:

Relocate either this product or the device that is being affected by the interference.

Utilize power outlets that are on different branch (circuit breaker or fuse) circuits or install AC line filter/s.

In the case of radio or TV interference, relocate/reorient the antenna. If the antenna lead-in is 300 ohm ribbon lead, change the lead-in to co-axial type cable.

If these corrective measures do not produce satisfactory results, please contact the local retailer authorized to distribute this type of product. If you can not locate the appropriate retailer, please contact Yamaha Corporation of America, Electronic Service Division, 6600 Orangethorpe Ave, Buena Park, CA 90620

*This applies only to products distributed by YAMAHA CORPORATION OF AMERICA

CANADA

This digital apparatus does not exceed the "Class B" limits for radio noise emissions from digital apparatus set out in the Radio Interference Regulation of the Canadian Department of Communications.

Le présent appareil numérique n'émet pas de bruits radio-électriques dépassant les limites applicables aux appareils numériques de la "Classe B" prescrites dans le Règlement sur le brouillage radioélectrique édicté par le Ministère Des Communications du Canada.

*This applies only to products distributed by YAMAHA CANADA MUSIC LTD.

IMPORTANT NOTICE FOR THE UNITED KINGDOM

Connecting the Plug and Cord

WARNING: THIS APPARATUS MUST BE EARTHED

IMPORTANT: The wires in this mains lead are coloured in accordance with the following code:

GREEN-AND-YELLOW	:	EARTH
BLUE	:	NEUTRAL
BROWN	:	LIVE

As the colours of the wires in the mains lead of this apparatus may not correspond with the coloured markings identifying the terminals in your plug, proceed as follows:

The wire which is coloured GREEN-AND-YELLOW must be connected to the terminal in the plug which is marked by the letter E or by the safety earth symbol  or coloured GREEN or GREEN-AND-YELLOW.

The wire which is coloured BLUE must be connected to the terminal which is marked with the letter N or coloured BLACK.

The wire which is coloured BROWN must be connected to the terminal which is marked with the letter L or coloured RED.

Contents

Congratulations	2
Precautions	3
The front panel	4
The rear panel	5
Memory areas	6
How the memories are arranged in the YDP2006	6
Recalling an equalization setting	6
Storing an equalization setting	6
A note on software protection	6
Using the display	7
The PEQ and NOTCH keys	7
Display when in stereo mode	7
Display when in mono mode	8
The L/◀ and R/▶ keys	8
Linking channels	9
The PEQ, notch and HPF and LPF indicators	9
Utilities	10
SYSTEM SETUP	10
TITLE EDIT	10
BULK DUMP	11
Y-485 NETWORK	11
Y-485 COMM. I/O	12
PARAMETER COPY	12
SOFTWARE PROTECT	13
MIDI CONTROL	13
DELAY DISPLAY	13
TUTORIAL	14
Finding a suitable memory area in which to store the setting	14
Initializing the memory area	14
Linking the L and R channels	14
Making parametric equalizer settings	15
Using the notch filters, and the HPF and LPF	16
I. Turning the filters on and off individually	16
II. Editing the filters graphically	16
III. Editing the filters numerically	17
Setting up the input level, attenuation and delay	18
I. Input level and input attenuation	18
II. Delay	18
Specifications	19
MIDI Implementation Chart	65
User programs	66
Program change table	67
Block diagram	68
Dimensions	69

Congratulations

Your new YDP2006 Digital Parametric Equalizer uses the most advanced Yamaha digital signal processing to provide extremely precise, stable equalization.

As well as a stereo 6 band parametric equalizer, the YDP2006 Digital Parametric Equalizer has a high and low pass filter, and 4 notch filters which can be used to selectively “knock out” specific frequencies. When running in mono mode, the YDP2006 provides not 6, but 12 bands, and 8 notch filters. Furthermore, the unit can operate at either 6 or 12dB cut/boost.

If you are used to using conventional analog parametric equalizers with knobs you will find the YDP2006 very easy to use. Selecting “knobs” and “turning” them are simple operations performed with rotary encoders on the front panel. With a multi-function LCD screen, you can see at a glance exactly which “knob”, or notch filter you are moving. Or if you prefer, you can change to a purely numeric display for the parametric filter and notch filter parameters.

One of the biggest advantages of Yamaha digital equalizers (apart from their stunning 20 bit sound) is the ability to store the equalizer settings you create for instant recall. The YDP2006 has the ability to store 40 different settings in this way, avoiding the need to completely reconfigure the knobs every time the unit has to be used for a different purpose, or in another environment.

In order to satisfy the most demanding needs of music professionals, the YDP2006 is able to be controlled not only by MIDI, but also by the new standard Y-485 interface. This allows for the fastest possible system configuration, without having to use up an extra MIDI channel to send program changes.

We urge you to read this manual carefully before using this unit, in order to fully appreciate, and be able to take advantage of, the many advanced features it offers.

Precautions

Avoid excessive heat, humidity, dust and vibration

Keep the unit away from locations where it is likely to be exposed to high temperatures or humidity - such as near radiators, stoves, etc. Also avoid locations which are subject to excessive dirt accumulation or vibration which could cause mechanical damage.

Avoid physical shocks

Strong physical shocks to the unit can cause damage. Handle it with care.

Do not open the unit, or attempt repairs or modifications yourself

This product contains no user-serviceable parts. Refer all maintenance to qualified Yamaha service personnel. Opening the unit and/or tampering with the internal circuitry will void the warranty.

Make sure power is off before making or removing connections

Always turn the power OFF prior to connecting or disconnecting cables. This is important to prevent damage to the unit itself as well as other connected equipment.

Handle cables carefully

Always plug and unplug cables - including the AC cord - by gripping the connector, not the cord.

Clean with a soft dry cloth

Never use solvents such as benzine or thinner to clean the unit. Wipe clean with a soft, dry cloth.

Always use the correct power source

Make sure that the power source voltage specified on the rear panel matches your local AC mains supply:

U.S. & Canadian Model: 120V AC, 60Hz

General Model: 230V AC, 50Hz

UK and Australian Model: 240V AC, 50Hz

Backup battery

The unit contains a long-life lithium battery which maintains the contents of the buffer and user memory locations even when the unit is off. With normal use, the battery should last approximately 5 years. If the battery voltage falls below a certain level, a “***WARNING*** LOW BATTERY” message will appear on the screen when the power is turned on. If this occurs, have the battery replaced by at a qualified Yamaha service center. Do not attempt to replace the battery yourself!

The front panel

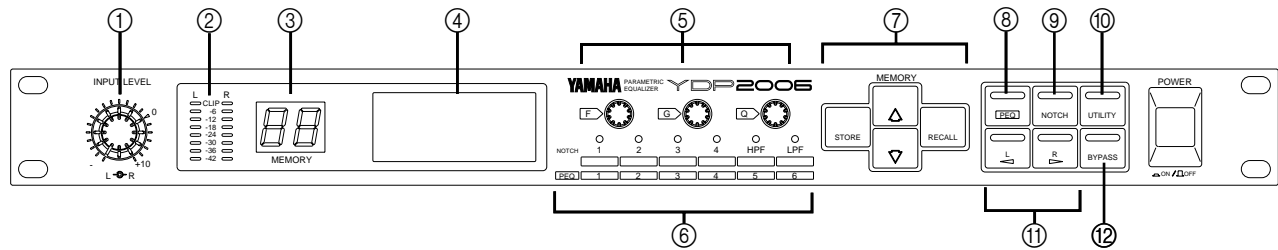

From left to right, the controls on the front panel are:

- ① **INPUT LEVEL** – two concentric rotary controls (inner control is left channel) to adjust the level of the signal fed into the YDP2006.
- ② **Level meters – L and R** – These meters come after the A-D converters in the signal chain. A “CLIP” indication therefore indicates digital distortion, and the input levels should be adjusted so that the “CLIP” indicators never light.
- ③ **Memory** – this 2-digit LED indicator shows the current memory area.
- ④ **Screen** – this 56 x 128 pixel display gives a graphic representation of the current equalization settings. It is also used to display other settings which you can edit using the front panel controls.
- ⑤ **Rotary encoders** – the **F**, **G** and **Q** controls are used primarily for setting the Frequency, Gain and Q of equalization bands. When editing utility settings, they may also be used for editing data.
- ⑥ **PEQ/NOTCH selectors and indicators** – When the PEQ key **8** is lit, the selectors are used to select a band from PEQ 1–6 (or either MONO.L 1–6, or MONO.R 1–6 when in mono mode).
When the NOTCH key **9** is lit, they are used to select a band among notches 1–4, and the HPF and LPF filters or, when in mono mode, MONO.L (1–4 and HPF and LPF) or MONO.R (1–4).
The indicators show the status of the various bands/filters, and light when the corresponding band/filter is on.
- ⑦ **MEMORY keys** – the **STORE**, **RECALL**, **▲** and **▼** keys are used to read and write settings stored in the 40 memory areas.
- ⑧ **PEQ key** – pressing this key will show the parameters for the parametric equalizer (in either graphic or numerical form), and enable the PEQ selectors. The indicators will show the on/off status of the parametric bands.
- ⑨ **NOTCH key** – pressing this key will show the parameters for the notch filters (in either graphic or numerical form), and enable the NOTCH selectors and indicators.
- ⑩ **UTILITY key** – pressing this key will cycle through a range of screens, allowing you to set up various system parameters for the unit.
- ⑪ **L/R and R/L keys** – you can make equalization settings for the left and right channels independently. These keys allow you to select which channel you are editing. By pressing one of these keys, holding it down, and then pressing the other, you can edit the parameters of both channels simultaneously.
- ⑫ **BYPASS key** – when pressed, the signal fed into the unit will bypass the internal circuitry, and will be re-output “as is”.

The rear panel

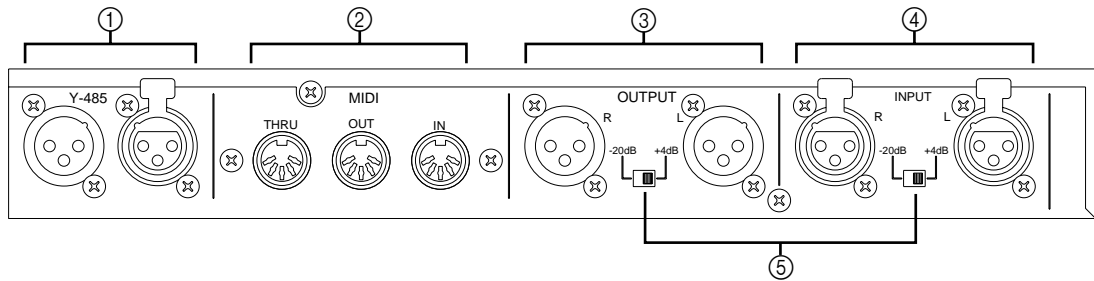



- ① **Y-485** – these bi-directional connectors are used to connect the unit on a network “chain” using the Y-485 control protocol. They do not carry audio signals. When making a Y-485 connection, either terminal may be used for IN or OUT.
Please use digital audio cable (impedance 90~120 Ω shield type equilibrium transmission cable) for connection with periphery equipment.
Using general analog audio cable (impedance 40~50 Ω shield type equilibrium transmission cable) could cause trouble such as signal reflection due to mismatching impedance and transmission waveform turbulence.
Waveform turbulence is especially noticeable with long cables, and with multi cable longer than 10 meters.
If the length of the cable is longer than 100 meters, it is recommended that it should be terminated with a resistor matching the impedance of the cable (connect a resistor of approx. 100 Ω between Pin 2 and Pin 3).
- ② **MIDI IN, OUT and THRU** – These terminals are used for MIDI control of the unit. IN is used to receive MIDI data, THRU passes along information received at the IN terminal, and OUT transmits data originated by the unit.
- ③ **OUTPUT (L, R)** – these balanced XLR-type connectors output the signal from the unit.
- ④ **INPUT (L, R)** – these balanced XLR-type connectors are used to input signals to the unit.
- ⑤ **Level switches** – both the input and output connectors may be set to nominal levels of +4dB or -20dB. When connecting other equipment, refer to the specifications of the other units to match the signal levels correctly.

Memory areas

How the memories are arranged in the YDP2006







The unit contains 40 memory areas which contain equalization settings, all of which are user-programmable. This allows you to set up and store frequently-used equalization settings which you can recall at any time. These settings can be stored to a mass-storage device (MIDI data file system or personal computer system) either through the MIDI interface, or the Y-485 connectors (see the section on “Utilities” for full details of this).

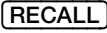

Recalling an equalization setting

Use the MEMORY  and  keys to display the name of the setting you want to recall. The name (set in UTILITY mode) is shown in the middle of the display, and the memory number flashes on the LED display.





Press the  key.

If you had not made any changes to the previous setting, the new setting will be displayed immediately.

If you had made changes to the previous setting without storing them, the unit will flash “RECALL OK?” in the center of the screen. If you really want to recall this setting, press the  key again (while this message is flashing, you can use the MEMORY  and  keys to select another setting to be recalled). If you press the  key, the number in the LED will stop flashing, and the screen will show the equalization curve for this setting. If you have made a mistake in selecting the setting or pressing the  key in the first place, and do not want to recall the setting, press any key except the  key.

Remember that the equalization curve shown will be for either the left or the right channel, depending on whether the  or  key is lit.

Storing an equalization setting

When you have edited a setting, you use the MEMORY  and  keys to select a memory area where you want to store the setting (if the memory area you are editing is the area where you want to store the setting, you do not need to press the  and  keys). As you step through the memory areas, the name of each one will be displayed in the center of the screen.

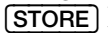
When you have selected the area, press the  key to write these settings into memory. The unit will flash “STORE OK?” in the center of the screen. Press the  key again to confirm the store, or any other key to cancel the store.

A note on software protection

You can protect the settings against accidental key-presses, etc., by using the UTILITY software protection (see “SOFTWARE PROTECT” on page 3). If protection is set to ON, then any attempt to store or recall settings using the methods described above will result in the message “ERR ** NOW PROTECT” being shown on the screen. The 2-digit LED will start to flash if you attempt to recall, store or modify a setting with protection on, as an additional warning. If you get the “ERR ** NOW PROTECT” message when trying to perform any operations with protection on, press any key to stop the LED flashing. “ERR ** NOW PROTECT” will disappear from the screen.

Using the display

The **PEQ** and **NOTCH** keys

Using the large LCD screen, your YDP2006 has several different ways of displaying settings, and being able to edit them. These different modes are accessed with the **PEQ** and **NOTCH** keys. Pressing the **PEQ** key will take you through the equalization displays, and pressing the **NOTCH** key will take you through the notch filter, and LPF and HPF filter displays.

NOTE

The displays differ in mono and stereo mode. To set the mono/stereo mode, refer to the “Utilities” section, later in the manual.

Display when in stereo mode:

PEQ displays:

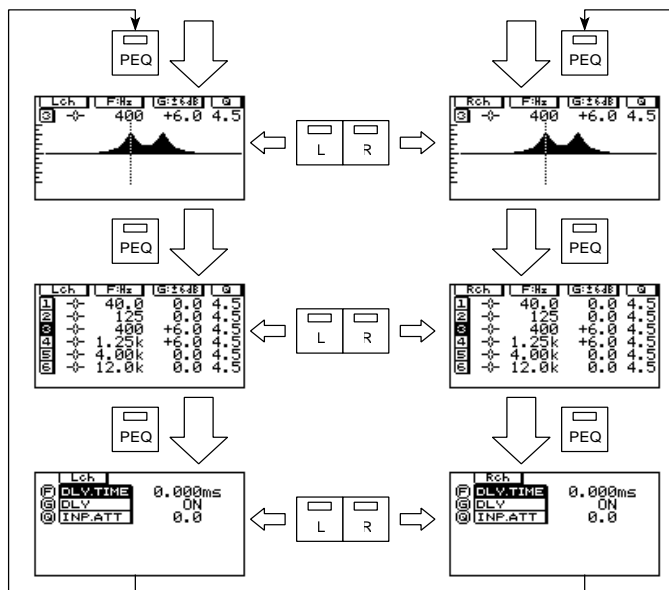

Graphical display of all active equalizer bands.

Numerical display of all equalizer bands.

Delay and attenuation parameters.

Notch displays:

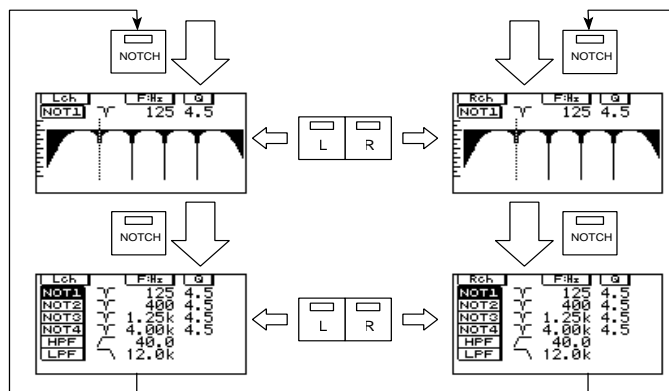

Graphical display of all active notch, HPF and LPF filters.

Numerical display of the notch, HPF and LPF parameters.

Display when in mono mode:

PEQ displays:

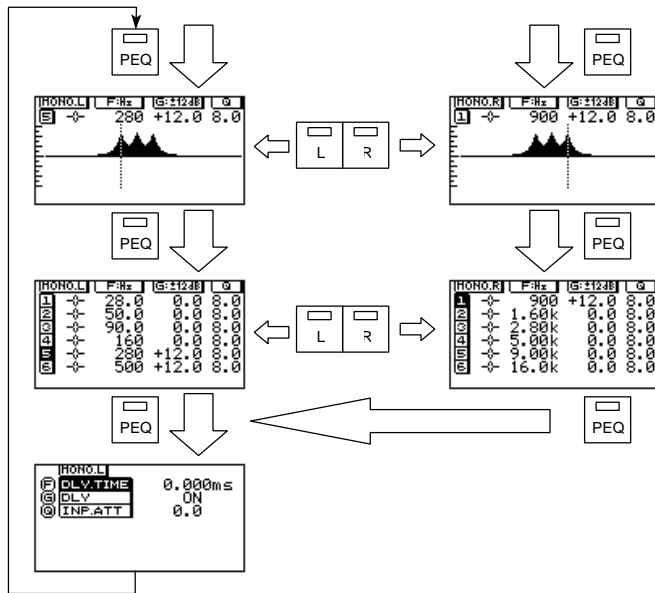

Graphical display of all active equalizer bands (MONO.L 1-6 on one screen and MONO.R 1-6 on the other).

Numerical display of all equalization bands (MONO.L 1-6 on one screen and MONO.R 1-6 on the other).

Delay and attenuation parameters.

Notch displays:

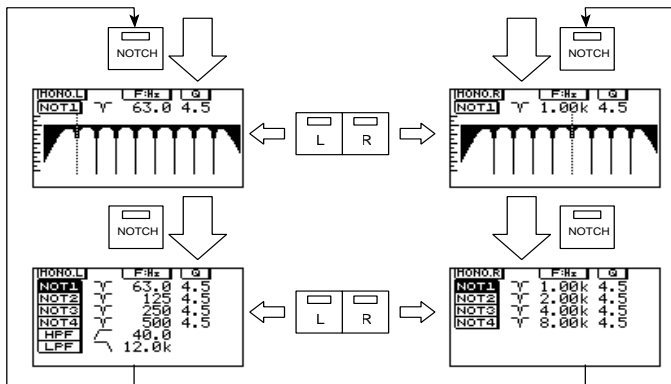

Graphical display of all active notch, HPF and LPF filters (filters MONO.L 1-4, HPF and LPF on one screen, and filters MONO.R 1-4 on the other).

Numerical display of the notch, HPF and LPF parameters.

The **[L/▶] and **[R/▶]** keys**

When in stereo mode, each of the above displays can show either the settings for the left channel, or the settings for the right channel. To select which channel will be displayed, press the **[L/▶]** or **[R/▶]** key. The LED on the corresponding key will light up, the display will change to show the new channel, and either R or L will appear in the top left of the screen.

In mono mode, if the unit is in PEQ mode, the **[L/▶]** and **[R/▶]** keys toggle between equalization bands MONO.L 1-6 and MONO.R 1-6. If the unit is in notch mode, the **[L/▶]** and **[R/▶]** keys toggle between notches 1-4, HPF, LPF (MONO.L), and MONO.R notches 1-4, as shown above.

Linking channels

In order to change both the L and R channels at the same time, the L and R channels must be linked. When the channels are linked, making any changes to one channel will also affect the other. Existing parameters from one channel will not be copied to the other channel, unless they are altered while the channels are linked.

To link the channels, press one of the two channel keys (either **L/◀** or **R/▶**), and while holding it down, press the other one. Because the screen can only show one channel at a time, only the settings of the first channel you pressed will be displayed, and the LED on that key will light. The settings of the other channel will not be displayed, and its LED will blink.

The PEQ, notch and HPF and LPF indicators

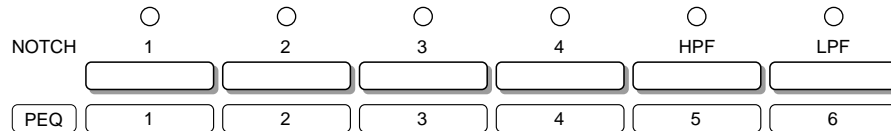

The small round LEDs above the PEQ and notch selectors indicate whether or not the corresponding PEQ band, or notch filter is active (turned on). When the LED on the PEQ key is on, the row of indicators refers to the PEQ bands. When the LED on the NOTCH key is on, the row of indicators refers to the notch, and LPF and HPF filters.

To turn a specific notch, filter or PEQ band on or off, it must first be selected for editing. If the parameters for the desired band are not displayed at the top of the screen (in graphical display screens), or the name of the notch highlighted on the left of the screen (in the text display modes), you must press the selector twice—once to select which notch, filter or PEQ band to change (this also selects it for editing), and once to toggle it between on and off. If the notch, filter or PEQ band is already selected for editing, simply pressing the selector once will do the toggling.

Put more simply, if you wish to toggle a notch, filter on/off that is already selected, just press the selector once. If it's not selected, press the selector twice.

Utilities

The **UTILITY** key allows you to set up various system parameters for the unit. Repeated presses of the key will cycle you through the following modes. You can also use the **▼** and **▲** keys to cycle through these parameters (but this will not return to the equalization setting display):

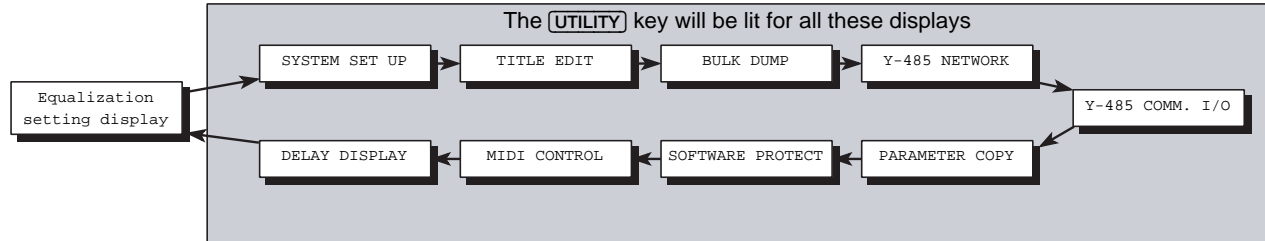

NOTE

You can also exit the UTILITY mode by pressing either the **PEQ** or **NOTCH** key.

SYSTEM SETUP

If you are in stereo mode, you will only have one parameter here: EMPHASIS. If you are in mono mode, you will also have the option (INP. MODE) of whether the signal is taken from the left or right input.

The emphasis function is a type of noise reduction and can effectively be used to reduce the high-frequency noise produced during A/D conversion and D/A conversion. It causes some deterioration of the dynamic range in the high-frequency range, however.

Because this equipment uses a 20-bit AD/DA converter, a sufficient dynamic range is assured even when the emphasis function is turned off. Setting it to OFF will work best for most material most of the time.

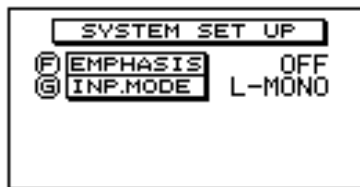

Emphasis: Use the **F** encoder to turn emphasis on and off (this trips an internal relay, so you will hear a “click” as this is switched).

Input mode: Use the **G** encoder (if you’re in mono mode) to set the input mode to either “L-MONO” (the signal is taken from the left channel input) or “R-MONO” (the signal is taken from the right input). This option is only available in mono mode.

TITLE EDIT

Each equalization setting may have a name. This may be useful in a mobile PA setup which is often used at the same venues at different times (a setting named “UNIV. STADIUM” is easier to remember again than program 23). Names set using this function are displayed on the screen whenever you step through the memory areas using the **▼** or **▲** keys.



Use the **F** encoder to select a character (0-9, A-Z, a-z + punctuation) and the **L/◀** and **R/▶** keys as cursor keys to determine which character will be edited. Use the **STORE** key as an easy way to enter a space.

BULK DUMP



Three parameters are available here:

Use the **F** encoder to select whether bulk dump operations will take place through the MIDI or Y-485 connections.

Use the **G** encoder to select what kind of data will be dumped. You can choose between: ALL DATA (all memory areas will be dumped), SYSTEM (the parameters you set up in the UTILITY menus will be dumped), MEMORY (a single memory area, or all memory areas will be dumped), and BANK (the Program Change tables).

If you have selected MEMORY with the **G** encoder, use the **@** encoder to select the memory area that you want to dump (1 through 40 or ALL).

If you have selected BANK with the **G** encoder, use the **@** encoder to select the Program Change bank you want to dump (A through D or ALL).

NOTE

You can dump this data over MIDI to a MIDI data file device (including a personal computer), or over the Y-485 network to a computer connected through the YAMAHA IFU485 interface.

There is no need to set the unit into any special receive mode to receive bulk dump data from an external device.

Y-485 NETWORK

The Y-485 network is more complex (in terms of software addressing) than the MIDI system. Each device on a network belongs to a group and has a device number within that group.

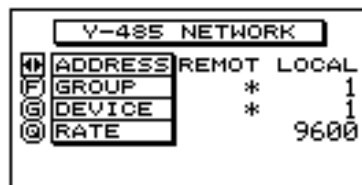

Use the **L/←** and **R/→** keys to decide whether you are editing the REMOTE or LOCAL settings. The LOCAL settings, of course, refer to this unit, and the REMOTE settings refer to a unit to which you will be sending data.

The **F** encoder allows you to set up a group number between 1 and 7. The Y-485 protocol allows messages to be sent to groups of units. If you are editing the REMOTE settings, you can also set this to a “*”. This is a “don’t care” value – the remote device address is irrelevant, and messages will be sent to all groups.

The **G** encoder allows you to set a device number inside the group between 1 and 31. If you are editing REMOTE settings, you can also set this to a “*”. This is a “don’t care” value – the remote device address is irrelevant, and messages will be sent to all devices.

The **@** encoder allows you to set the data transfer rate for the LOCAL settings only. This should usually be set to 9600 (even though a value of 38400 may be set).

To control this unit and other Y-485 units from a computer, you will require an IFU485 hardware interface, and computer software (QS-1) to control it. QS-1 software is available for both Macintosh and IBM-compatible computers. Contact Yamaha or your local Yamaha distributor for further details.

Y-485 COMM. I/O



Only one parameter is available here: the data which will be recognized by the unit over the Y-485 network. There are three values, selectable with the **F** encoder: OFF, PGM CHANGE and ALL. When OFF, no Y-485 messages will be recognized by the unit, when PGM CHANGE, only Program Change messages will be recognized by the unit, and when ALL, any data coming over the Y-485 interface will be recognized.

NOTE

These parameters are entirely independent of any data received at the MIDI ports.

PARAMETER COPY

This allows you to initialize new equalization settings from a “template” setting and to copy channel settings. The “template” settings allow you to set the mono/stereo mode, and the 6dB/12dB boost mode.

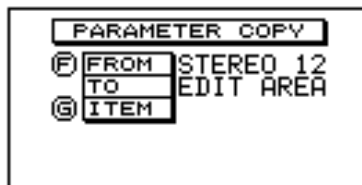

Use the **F** encoder to decide what setting you will use as the default, and where you will copy it to. There are four “template” settings available:

STEREO 12 is a stereo 6-band parametric EQ with 4 notch filters (plus HPF and LPF) and gain for each band of ± 12 dB.

STEREO 6 is a stereo 6-band parametric EQ with 4 notch filters (plus HPF and LPF) and gain for each band of ± 6 dB.

MONO 12 is a mono 12-band parametric EQ with 8 notch filters (plus HPF and LPF) and gain for each band of ± 12 dB.

MONO 6 is a mono 12-band parametric EQ with 8 notch filters (plus HPF and LPF) and gain for each band of ± 6 dB.

Select the “template” you want to use using the **F** encoder. The “template” will be copied to the edit area.

After the “template” settings, if the current setting is in stereo mode (STEREO 6 or STEREO 12), turning the **F** encoder will bring up two more options: from L-DATA to R-DATA and from R-DATA to L-DATA. This allows you to copy from one channel to another. If you are in mono mode, these options will of course not be available.

Using the **G** encoder, you can select what data is to be copied between channels: ALL (self-explanatory), EQ (the parametric equalization settings), FILTER (the notch filter settings), or DELAY/ATT (the delay and attenuation settings).

Whatever data you have chosen to copy (“template” or channel data) press the **STORE** key to start the copying process. If you have not set the software protection on, the message “** EXECUTING” will appear briefly on screen as the data is copied. If software protection is on, nothing will appear on screen, and no data will be copied when you press the **STORE** key.

SOFTWARE PROTECT



Use the **F** encoder to turn memory protection on or off. When ON, the unit will not respond to Program Change messages received over MIDI or Y-485. You will not be able to store or copy any new or edited equalization settings if protection is ON. "ERR ** NOW PROTECT" will appear on the screen if you try to store data while protection is ON.

MIDI CONTROL

The unit will respond to MIDI Program Change messages sent from a master keyboard, sequencer or other device. It may be useful to remap program change settings so that a Program Change message of 2, for instance, selects memory area 40.

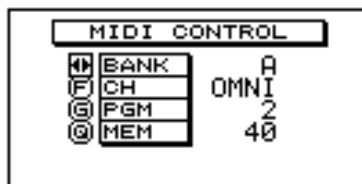

There are four "banks" of Program Change tables available – A through D. Use the **L** and **R** keys to select which bank will be edited. The bank displayed on this screen will remain the active bank after you have exited the UTILITY mode.

Use the **F** encoder to select the MIDI channel to which the bank will respond (OFF, 1 through 16 or OMNI).

Use the **G** encoder to select the Program Change number which will be recognized.

Use the **@** encoder to select the memory area which will be recalled when the Program Change number set with the **G** encoder is received.

NOTE

The currently-selected Program Change bank is also applicable when a Y-485 Program Change is received.

DELAY DISPLAY



When using the unit in a sound reinforcement application, it is very often useful to delay one or both channels to compensate for phase differences caused by speaker placement. In this menu, use the **F** encoder to select the units in which this delay will be expressed: FEET, METERS or SECONDS. The distance units (FEET, METERS) allow you to enter delay times expressed in distance (select the appropriate one, depending on your familiarity with the metric system). The SECONDS option allows you to enter delay times directly in milliseconds.

TUTORIAL

In this section we will go over the setting up of the YDP2006, from the parametric equalizer and the filters, to the delay and input attenuation. The information is presented as a tutorial—from it, you should be able to pick up the techniques necessary to make settings for any situation.

Finding a suitable memory area in which to store the setting

This may be an existing equalization setting which you wish to alter, or a completely new setting that you wish to create from scratch.

- 1 Ensure you are in one of the display screens (the utility indicator is off). If you're in utility mode, press the **PEQ** or **NOTCH** key.
- 2 To go to another memory setting, press the **MEMORY** **▲** or **▼** keys until the name of the setting appears on the screen, and its memory number flashes on the **MEMORY** display. Then press **RECALL** once. If you have edited the settings in the previous memory area, "RECALL OK?" will appear on the display as a warning—press **RECALL** again to recall the new setting.
- 3 If you seem to be having problems with this, and "ERR ** NOW PROTECT" appears on the display, the memory is protected. See the "Utilities" section.

Initializing the memory area

If you wish to start creating a setting from scratch, and there is an existing setting at the memory location you are working at, you can clear the existing setting using the **PARAMETER COPY** function (see the "Utilities" section). This will also allow you to set whether the equalizer is in stereo mode (6 PEQ bands, and 4 notch filters per channel), or mono mode (12 PEQ bands, and 8 notch filters), and also whether the maximum cut/boost is 6dB or 12dB.

Settings in the PARAMETER COPY function

Display	Mode	Maximum cut/boost
STEREO 12	Stereo	12dB
STEREO 6	Stereo	6dB
MONO 12	Mono	12dB
MONO 6	Mono	6dB

Linking the L and R channels

If you are working in stereo mode, you will probably frequently want to set up the L and R channels identically (at least for most of the settings), and then tweak the L and R channels separately. Linking the channels is the way to achieve this.

To link the channels, press one of the two channel keys (either **L/◀** or **R/▶**), and while holding it down, press the other one. Only the settings of the first channel you pressed will be displayed, and the LED on that key will light.

Linking the channels does *not* automatically copy all parameters from one channel to the other. Only the parameters that you create or change while the channels are linked will be made to both channels.

Making parametric equalizer settings

Here is where the user interface of the YDP2006 really makes parametric equalization easy. For the most part, you will never need to set any parameters numerically (unless you want to)—the resulting frequency response of the equalizer, and the notch filters can be displayed graphically on the screen.

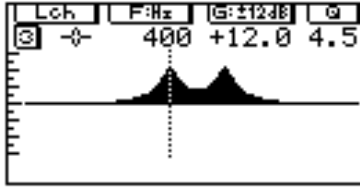

- 1 Press the **PEQ** key until you see a screen similar to the one shown. The number of the currently selected band is shown below the channel indication in the top left corner of the display. The actual settings on your screen will probably be different to the ones shown here.
- 2 Select which equalization band you wish to edit. If the number of this band is not shown below the channel indication ("Lch", "Rch", "MONO.L" or "MONO.R") at the top left of the screen, press the corresponding PEQ selector to select it. The number of the band will appear below the channel indication.
In mono mode, press either **L/◀** or **R/▶** to toggle between the display of bands MONO.L 1-6 and MONO.R 1-6.

Each band can only be set within a certain frequency range. These ranges are shown in the table below. As can be seen, the ranges overlap to a large degree, making them very flexible.

Frequency ranges and Q for each equalizer band

<i>Band (Stereo mode)</i>	<i>Band (Mono mode)</i>	<i>Frequency</i>	<i>Q</i>
L1, R1	L1	20 Hz – 20.0 kHz	LSH, 0.5 – 10.0
L2 – L5	L2 – L6		0.5 – 10.0
R2 – R5	R1 – R5		
L6, R6	R6		HSH, 0.5 – 10.0

- 3 If you wish to see/hear the effects of the equalization band while it is being edited, make sure that the PEQ for the band is turned on (the appropriate PEQ indicator LED is lit). If it is not, press the corresponding PEQ selector. The current settings for the band will be shown in graphical form on the screen.
- 4 Turn the **F** rotary encoder, and notice how the dotted bar moves to the left and right. This is the frequency selector—any changes you will make with the gain rotary encoder affect only this frequency.

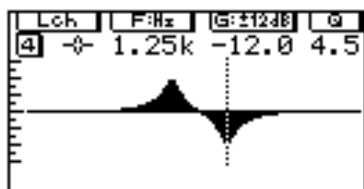
**NOTE**

Remember that the settings for only one channel are displayed at a time, and you can toggle between them with the **[L/◀]** and **[R/▶]** keys. If you have linked the channels, the channel displayed will be the one indicated at the top left of the screen (Lch or Rch).

- Once the desired settings have been created, don't forget to store them in one of the memory areas, so you can use them again at a later time.

Using the notch filters, and the HPF and LPF

Besides the HPF and LPF, which are shelving high-pass and low-pass filters, respectively, the notch filters provide very selective gain cuts, with adjustable Q. One of their main uses is to filter out sounds that occur at specific frequencies, such as 50/60 Hz AC hum, or the high frequency noise induced by some fluorescent lighting, or lighting dimmers. Of course, to avoid affecting the original material any more than necessary, try to use the narrowest notch possible that will remove the offending signals.

Q is a measure of the resonance of the filter. Basically, the higher the Q, the narrower the notch. Except for setting the Q, the process for setting the notch filters and the HPF and LPF is exactly the same (the shelving HPF and LPF don't have Q).

I. Turning the filters on and off individually

- You must be in notch mode (the indicator on the **[NOTCH]** key on). If you are not, then press the **[NOTCH]** key.
- Use the **[L/◀]** or **[R/▶]** keys to select the appropriate left or right channel display (in stereo mode), or to choose between notches MONO.L 1-4, HPF and LPF, and notches MONO.R 1-4 (in mono mode).
- Then, ensure the notch or filter is selected for editing (you may need to press the corresponding selector once to do this), then press the appropriate selector to toggle it on/off.

II. Editing the filters graphically

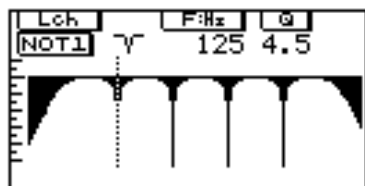

- Press the **[NOTCH]** key until you see a screen similar to the one here. If you are in mono mode, there are two screens like this (accessed with the **[L/◀]** or **[R/▶]** keys)—one for notches MONO.L 1-4, HPF and LPF, and one for notches MONO.R 1-4. The actual settings on your screen will probably be different to the ones shown here.

- To select a filter for editing (if it's not already selected), press one of the notch or filter selectors. The indication in the top left corner below the "Lch", "Rch" or "MONO" indication shows the filter that is currently selected for editing. It will either show NOT1, 2, 3 or 4, HPF or LPF.

NOTE

If you wish to see and hear the effects of the filter while you are editing it, make sure the indicator above the filter selector is on. If not, press the selector.

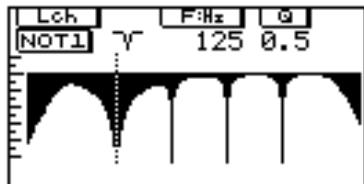

- Use the F rotary encoder to move the filter up or down the frequency band.
- For the notch filters, use the Q rotary encoder to alter the Q of the notch. As you adjust the filter parameters, the F (and Q if you're not editing the HPF or LPF) will be shown numerically at the top of the screen. If the filter is turned on (the appropriate indicator is lit), the screen will show the frequency response of the filter settings. Notice the extra width of the notch on the left, with Q of 0.5.

III. Editing the filters numerically

Lch		F:Hz	Q
NOT1	Y	125	4.5
NOT2	Y	400	4.5
NOT3	Y	1.25k	4.5
NOT4	Y	4.00k	4.5
HPF	/	40.0	
LPF	/	12.0k	

- Press the **NOTCH** key until you see a screen similar to the one shown. The screen shown is the one displayed in stereo mode. If you are in mono mode, there are two screens like this (accessed with the **L/** or **R/** keys)—one for notches MONO.L 1-4, HPF and LPF, and one for notches MONO.R 1-4. The actual settings on your screen will probably be different to the ones shown here.
- To select a filter for editing (if it's not already selected), press one of the notch or filter selectors. The corresponding "NOT", "HPF" or "LPF" indication on the left side of the screen will become highlighted, and a cursor will appear beneath the parameters for the currently selected filter (either the F or Q parameter will be underlined). For any filters that are off, a dash ("—") will appear in the second column of the display. For filters that are on, this is replaced by a small symbol representing the filter.

NOTE

If you wish to hear the effects of the filter while you are editing it, make sure the indicator above the filter selector is on. If not, press the appropriate selector to turn it on.

- Use the F rotary encoder to alter the frequency of the filter.
- For the notch filters, use the Q rotary encoder to alter the Q of the notch. The figure shown is adjustable from 0.5 to 10.0 (10.0 is the narrowest). Of course, the HPF and LPF shelving filters do not take Q values.

Setting up the input level, attenuation and delay

I. Input level and input attenuation

There are two operations on the YDP2006 that affect the input level—the input level control in the analog domain (pre A/D converters), and the attenuation parameter (INP.ATT) in the digital domain (post A/D converters).

The input level control (on the front panel) should be set so that the level meters register the highest possible level without the CLIP indicator lighting.

The input attenuation parameter is provided to compensate for equalizer settings that alter the overall gain of the sound. e.g. If the equalizer settings result in an overall gain increase of 4dB (for example), internal clipping may occur even if the level meters do not indicate clipping.

As a guide to input attenuation level, adjust it so that the output volume is the same as when the bypass function is used. The attenuation can be set from 0dB to infinity (∞), with the highest numerical value being shown as 50 (see instructions below).

II. Delay

In sound reinforcement situations, it is often desirable for the sound from various loudspeakers to be delayed, to compensate for phase delay caused by speaker placement. Due to its position in the signal chain, the equalization stage is a good place to add this delay.

The YDP2006 can delay signals by up to 714 milliseconds (242m, about 800ft) in stereo mode, or 1428 milliseconds (485m, about 1593ft) in mono mode. You can input this information either directly as milliseconds, or as a distance in feet or meters (set your preference in the “Utilities”). You can make individual settings for both channels, or for both channels at the same time by linking L and R. These settings are stored in the memory area along with the equalization settings.

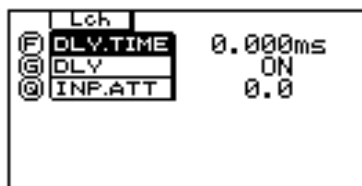

- 1 Press the **PEQ** key until you see a screen similar to the one shown. The actual settings on your screen will probably be different to the ones shown here.
- 2 If you wish to alter both channels simultaneously, link the channels.
- 3 Use the **F** rotary encoder to set the delay. To change the units used (msec, meters or feet), see the “Utilities” section.
- 4 Use the **G** rotary encoder to enable (“ON”) or disable (“OFF”) the delay you have set.
- 5 Use the **@** rotary encoder to set the channel input attenuation.
- 6 Don’t forget to store the completed settings in one of the memory areas, so you can use them again at a later time.

Specifications

Frequency response		20Hz to 20kHz 0 ±1, 0dB
Dynamic range	Emphasis ON	typical, 110dB
		> 104dB
	Emphasis OFF	typical, 106dB
		> 100dB
Hum and noise	Emphasis ON	< -80dBm
	Emphasis OFF	<-76dBm
Distortion	(max level, Emphasis ON)	< 0.007%
	(max level, Emphasis OFF)	<0.01%
Inputs	Channel inputs	2 (balanced)
	Nominal input level	+4/-20dBm (switchable)
	Maximum input level	+24dBm (switch at +4dB)
	Input impedance	20kΩ
Outputs	Channel outputs	2 (balanced)
	Nominal output level	+4/-20dBm (switchable)
	Maximum output level	+24dBm (switch at +4dB)
	Output impedance	150Ω
A/D and D/A convertors	A/D resolution	20-bit linear
	D/A resolution	20-bit linear
	Frequency response	44.1kHz
Memory areas		40 (all user-programmable)
MIDI control		Program Change messages select memory areas
Power requirements	USA and Canadian model	120V/60Hz
	General model	230V/50Hz
	UK and Australian model	240V/50Hz
Power consumption	(all models)	25W
Dimensions (w x d x h)	mm (in)	480 x 335 x 45 (18.9 x 13.2 x 1.8) (19" 1U rackmount)
Weight	kg (lb)	4.6 (10.1)

Function		Transmitted	Recognized	Remarks
Basic Channel	Default	X	1 - 16, off	memorized
	Changed	X	1 - 16, off	
Mode	Default	X	OMNI off/OMNI on	memorized
	Messages	X	X	
	Altered	*****	X	
Note Number	:True Voice	X	X	
		*****	X	
Velocity	Note ON	X	X	
	Note OFF	X	X	
After Touch	Key's	X	X	
	Ch's	X	X	
Pitch Bender		X	X	
Control Change		X	X	
Prog Change	:True #	X	O	*1
System Exclusive		O	O	Bulk Dump
System Common	:Song Pos	X	X	
	:Song Sel	X	X	
	:Tune	X	X	
System Real Time	:Clock	X	X	
	:Commands	X	X	
Aux Messages	:Local ON/OFF	X	X	
	:All Notes OFF	X	X	
	:Active Sense	X	X	
	:Reset	X	X	

Notes: *1 = For program 1 - 128, memory 1 - 40 is selected.

User programs / Programmes utilisateur / User-Programme

Unit number: _____ Programmer: _____ Backed up to: _____ Date: _____

Memory area	Program name:	Date:	Comments:
1			
2			
3			
4			
5			
6			
7			
8			
9			
10			
11			
12			
13			
14			
15			
16			
17			
18			
19			
20			
21			
22			
23			
24			
25			
26			
27			
28			
29			
30			
31			
32			
33			
34			
35			
36			
37			
38			
39			
40			

Program change table / Tableau de changement de programme / Program-Change-Tabelle

Unit number: _____ Bank: _____ Backed up to: _____ Date: _____

Received	Selects:	Received	Selects:	Received	Selects:	Received	Selects:
1		33		65		97	
2		34		66		98	
3		35		67		99	
4		36		68		100	
5		37		69		101	
6		38		70		102	
7		39		71		103	
8		40		72		104	
9		41		73		105	
10		42		74		106	
11		43		75		107	
12		44		76		108	
13		45		77		109	
14		46		78		110	
15		47		79		111	
16		48		80		112	
17		49		81		113	
18		50		82		114	
19		51		83		115	
20		52		84		116	
21		53		85		117	
22		54		86		118	
23		55		87		119	
24		56		88		120	
25		57		89		121	
26		58		90		122	
27		59		91		123	
28		60		92		124	
29		61		93		125	
30		62		94		126	
31		63		95		127	
32		64		96		128	

Block diagram / Schéma de principe / Blockdiagramm

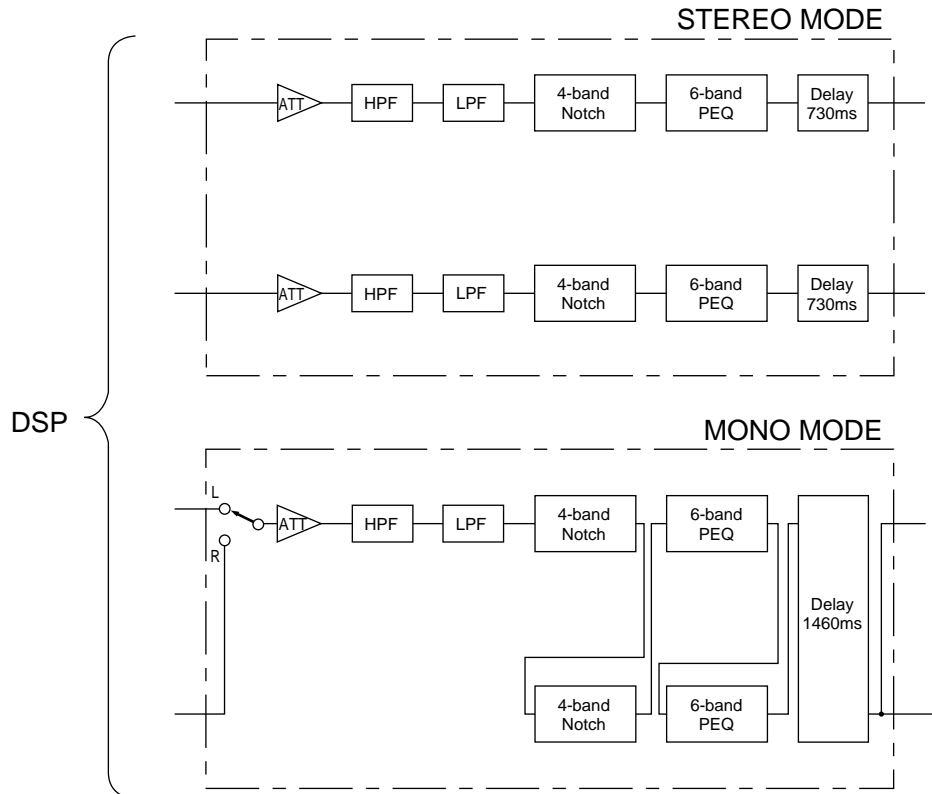
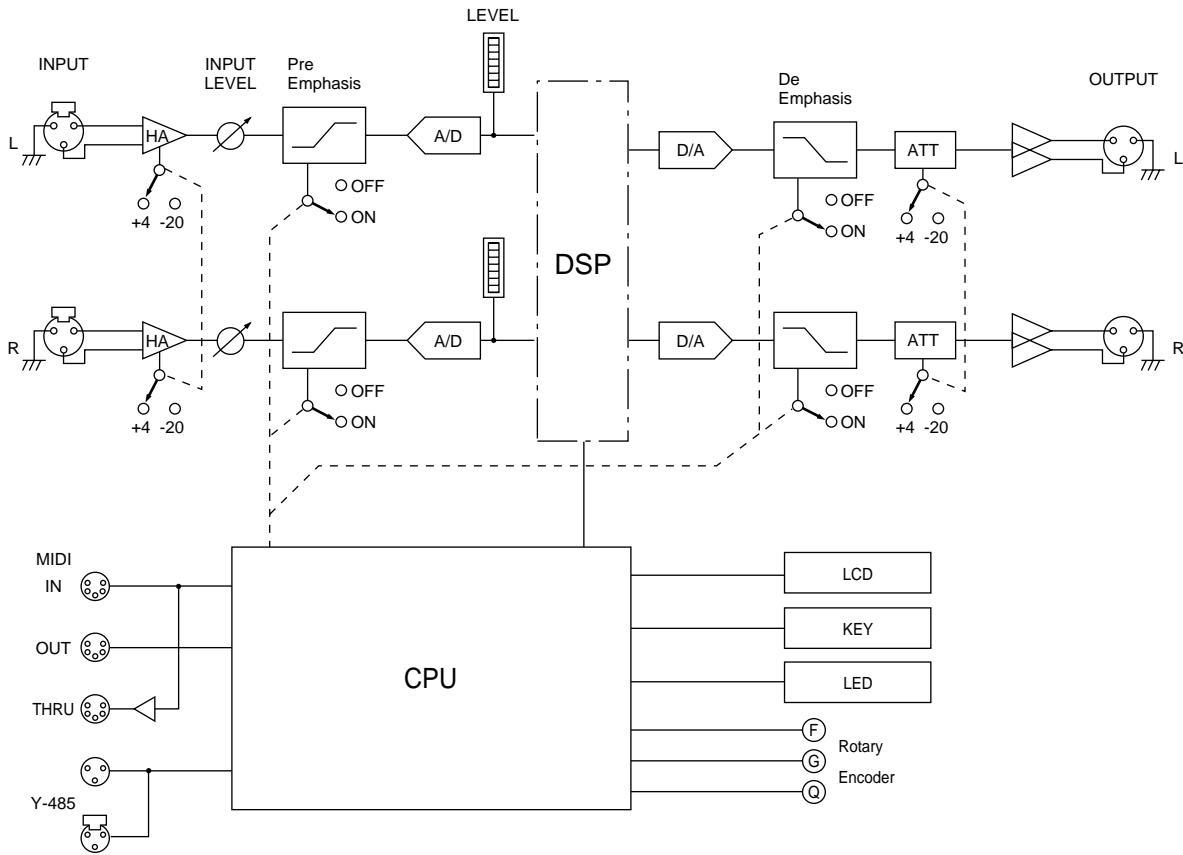

Dimensions / Abmessungen

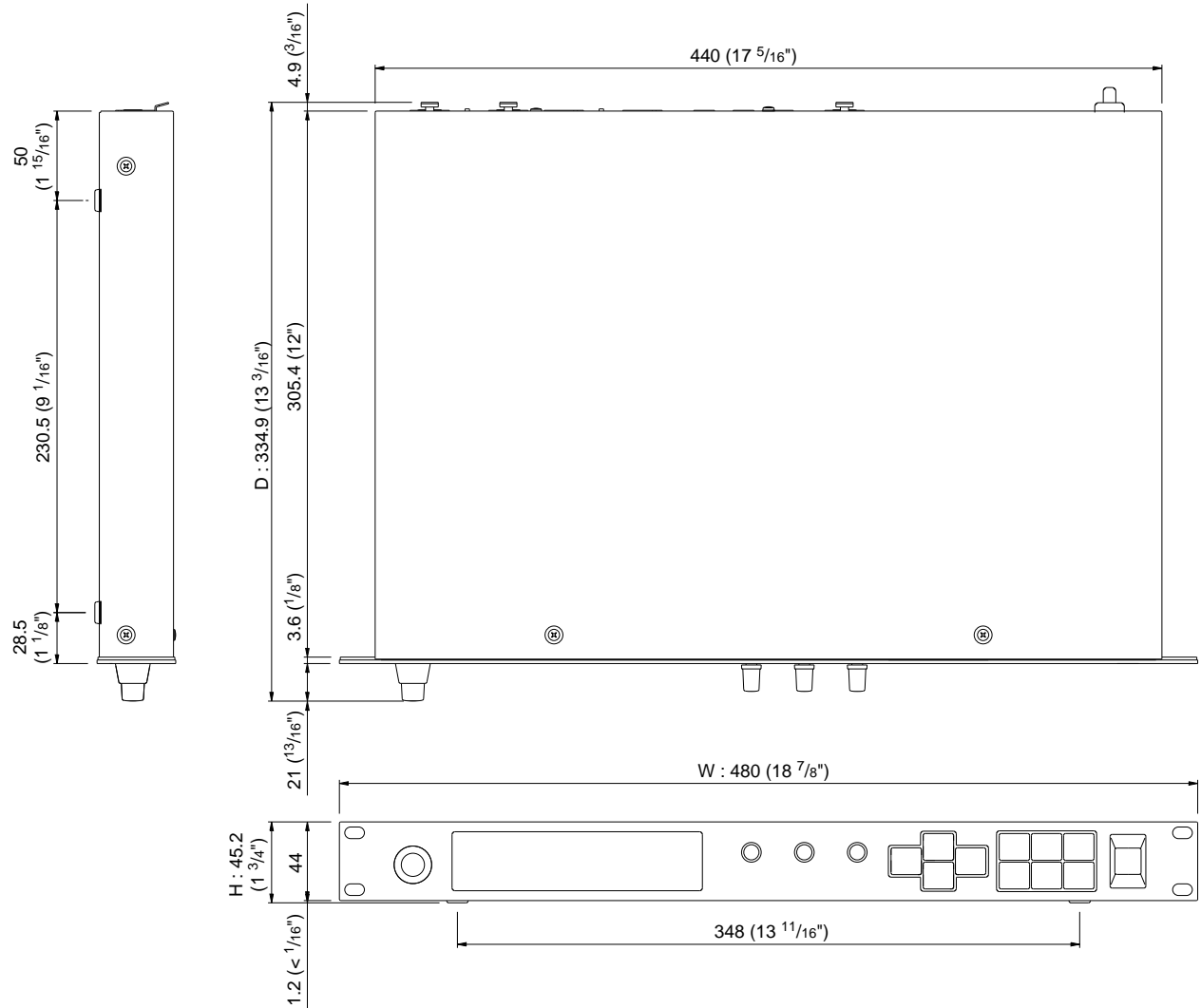

All measurements given in mm (inches). Inch values given to nearest $\frac{1}{16}$ ".

Toutes les mesures sont données en millimètres (pouces). Précision d' $\frac{1}{16}$ pour les valeurs en pouces.

Alle Maße in mm (Zoll). Zoll-Angaben mit einer Genauigkeit von $\frac{1}{16}$ ".

Litiumbatteri!
Bör endast bytas av servicepersonal.
Explosionsfara vid felaktig hantering.

VAROITUS!
Lithiumparisto, Räjähdyksvaara.
Pariston saa vaihtaa ainoastaan aian
ammattimies.

ADVARSEL!
Lithiumbatteri!
Eksplønsionsfare. Udskiftning må kun foretages
af en sagkyndig, – og som beskrevet i
servicemanualen.

YAMAHA

VQ95590 R2 1 CR 72

97 09 500 CR Printed in Japan

YAMAHA CORPORATION
P.O.Box 1, Hamamatsu, Japan