



HTR-5450

HTR-5440

Natural Sound AV Receiver
Ampli-tuner audio-vidéo

OWNER'S MANUAL
MODE D'EMPLOI

SAFETY INSTRUCTIONS

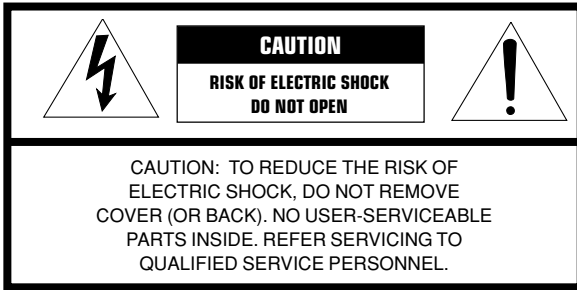

- Explanation of Graphical Symbols

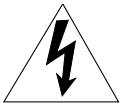

The lightning flash with arrowhead symbol, within an equilateral triangle, is intended to alert you to the presence of uninsulated "dangerous voltage" within the product's enclosure that may be of sufficient magnitude to constitute a risk of electric shock to persons.



The exclamation point within an equilateral triangle is intended to alert you to the presence of important operating and maintenance (servicing) instructions in the literature accompanying the appliance.

WARNING

TO REDUCE THE RISK OF FIRE OR ELECTRIC SHOCK, DO NOT EXPOSE THIS UNIT TO RAIN OR MOISTURE.

- 1 Read Instructions – All the safety and operating instructions should be read before the unit is operated.
- 2 Retain Instructions – The safety and operating instructions should be retained for future reference.
- 3 Heed Warnings – All warnings on the unit and in the operating instructions should be adhered to.
- 4 Follow Instructions – All operating and other instructions should be followed.
- 5 Water and Moisture – The unit should not be used near water – for example, near a bathtub, washbowl, kitchen sink, laundry tub, in a wet basement, or near a swimming pool, etc.
- 6 Carts and Stands – The unit should be used only with a cart or stand that is recommended by the manufacturer.
- 6A A unit and cart combination should be moved with care. Quick stops, excessive force, and uneven surfaces may cause the unit and cart combination to overturn.
- 7 Wall or Ceiling Mounting – The unit should be mounted to a wall or ceiling only as recommended by the manufacturer.



- 8 Ventilation – The unit should be situated so that its location or position does not interfere with its proper ventilation. For example, the unit should not be situated on a bed, sofa, rug, or similar surface, that may block the ventilation openings; or placed in a built-in installation, such as a bookcase or cabinet that may impede the flow of air through the ventilation openings.
- 9 Heat – The unit should be situated away from heat sources such as radiators, stoves, or other appliances that produce heat.
- 10 Power Sources – The unit should be connected to a power supply only of the type described in the operating instructions or as marked on the unit.
- 11 Power-Cord Protection – Power-supply cords should be routed so that they are not likely to be walked on or pinched by items placed upon or against them, paying particular attention to cords at plugs, convenience receptacles, and the point where they exit from the unit.
- 12 Cleaning – The unit should be cleaned only as recommended by the manufacturer.
- 13 Nonuse Periods – The power cord of the unit should be unplugged from the outlet when left unused for a long period of time.
- 14 Object and Liquid Entry – Care should be taken so that objects do not fall into and liquids are not spilled into the inside of the unit.
- 15 Damage Requiring Service – The unit should be serviced by qualified service personnel when:
 - A. The power-supply cord or the plug has been damaged; or
 - B. Objects have fallen, or liquid has been spilled into the unit; or
 - C. The unit has been exposed to rain; or
 - D. The unit does not appear to operate normally or exhibits a marked change in performance; or
 - E. The unit has been dropped, or the cabinet damaged.
- 16 Servicing – The user should not attempt to service the unit beyond those means described in the operating instructions. All other servicing should be referred to qualified service personnel.
- 17 Power Lines – An outdoor antenna should be located away from power lines.
- 18 Grounding or Polarization – Precautions should be taken so that the grounding or polarization is not defeated.

19 For US customers only:

Outdoor Antenna Grounding – If an outside antenna is connected to this unit, be sure the antenna system is grounded so as to provide some protection against voltage surges and built-up static charges. Article 810 of the National Electrical Code, ANSI/NFPA 70, provides information with regard to proper grounding of the mast and supporting structure, grounding of the lead-in wire to an antenna discharge unit, size of grounding conductors, location of antenna discharge unit, connection to grounding electrodes, and requirements for the grounding electrode.

Note to CATV system installer:

This reminder is provided to call the CATV system installer's attention to Article 820-40 of the NEC that provides guidelines for proper grounding and, in particular, specifies that the cable ground shall be connected to the grounding system of the building, as close to the point of cable entry as practical.

EXAMPLE OF ANTENNA GROUNDING

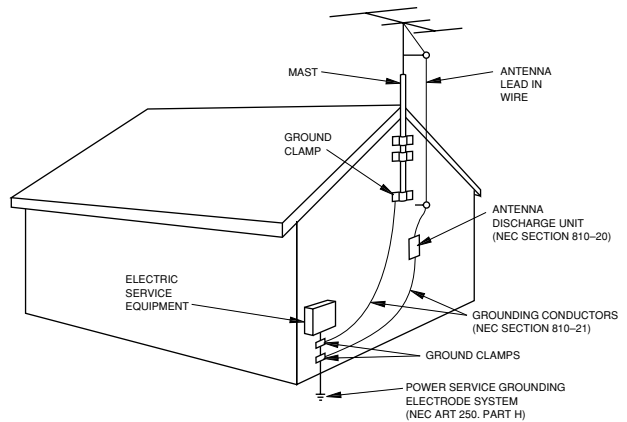

NEC – NATIONAL ELECTRICAL CODE

FCC INFORMATION (for US customers only)**1. IMPORTANT NOTICE : DO NOT MODIFY THIS UNIT!**

This product, when installed as indicated in the instructions contained in this manual, meets FCC requirements. Modifications not expressly approved by Yamaha may void your authority, granted by the FCC, to use the product.

2. IMPORTANT : When connecting this product to accessories and/or another product use only high quality shielded cables. Cable/s supplied with this product **MUST** be used. Follow all installation instructions. Failure to follow instructions could void your FCC authorization to use this product in the USA.**3. NOTE :** This product has been tested and found to comply with the requirements listed in FCC Regulations, Part 15 for Class "B" digital devices. Compliance with these requirements provides a reasonable level of assurance that your use of this product in a residential environment will not result in harmful interference with other electronic devices.

This equipment generates/uses radio frequencies and, if not installed and used according to the instructions found in the users manual, may cause interference harmful to the operation of other electronic devices.

Compliance with FCC regulations does not guarantee that interference will not occur in all installations. If this product is found to be the source of interference, which can be determined by turning the unit "OFF" and "ON", please try to eliminate the problem by using one of the following measures:

Relocate either this product or the device that is being affected by the interference.

Utilize power outlets that are on different branch (circuit breaker or fuse) circuits or install AC line filter/s.

In the case of radio or TV interference, relocate/reorient the antenna. If the antenna lead-in is 300 ohm ribbon lead, change the lead-in to coaxial type cable.

If these corrective measures do not produce satisfactory results, please contact the local retailer authorized to distribute this type of product. If you can not locate the appropriate retailer, please contact Yamaha Electronics Corp., U.S.A. 6660 Orangethorpe Ave, Buena Park, CA 90620.

The above statements apply **ONLY** to those products distributed by Yamaha Corporation of America or its subsidiaries.

We Want You Listening For A Lifetime

YAMAHA and the Electronic Industries Association's Consumer Electronics Group want you to get the most out of your equipment by playing it at a safe level. One that lets the sound come through loud and clear without annoying blaring or distortion – and, most importantly, without affecting your sensitive hearing.

Since hearing damage from loud sounds is often undetectable until it is too late, YAMAHA and the Electronic Industries Association's Consumer Electronics Group recommend you to avoid prolonged exposure from excessive volume levels.



CAUTION: READ THIS BEFORE OPERATING YOUR UNIT.

- 1 To assure the finest performance, please read this manual carefully. Keep it in a safe place for future reference.
- 2 Install this unit in a well ventilated, cool, dry, clean place with at least 30 cm on the top, 20 cm on the right and left, and 10 cm at the back of this unit for ventilation space — away from direct sunlight, heat sources, vibration, dust, moisture, and/or cold.
- 3 Locate this unit away from other electrical appliances, motors, or transformers to avoid humming sounds. To prevent fire or electrical shock, do not place this unit where it may get exposed to rain, water, and/or any type of liquid.
- 4 Do not expose this unit to sudden temperature changes from cold to hot, and do not locate this unit in a environment with high humidity (i.e. a room with a humidifier) to prevent condensation inside this unit, which may cause an electrical shock, fire, damage to this unit, and/or personal injury.
- 5 On the top of this unit, do not place:
 - Other components, as they may cause damage and/or discoloration on the surface of this unit.
 - Burning objects (i.e. candles), as they may cause fire, damage to this unit, and/or personal injury.
 - Containers with liquid in them, as they may cause electrical shock to the user and/or damage to this unit.
- 6 Do not cover this unit with a newspaper, tablecloth, curtain, etc. in order not to obstruct heat radiation. If the temperature inside this unit rises, it may cause fire, damage to this unit, and/or personal injury.
- 7 Do not plug in this unit to a wall outlet until all connections are complete.
- 8 Do not operate this unit upside-down. It may overheat, possibly causing damage.
- 9 Do not use force on switches, knobs and/or cords.
- 10 When disconnecting the power cord from the wall outlet, grasp the plug; do not pull the cord.
- 11 Do not clean this unit with chemical solvents; this might damage the finish. Use a clean, dry cloth.
- 12 Only voltage specified on this unit must be used. Using this unit with a higher voltage than specified is dangerous and may cause fire, damage to this unit, and/or personal injury. YAMAHA will not be held responsible for any damage resulting from use of this unit with a voltage other than specified.
- 13 To prevent damage by lightning, disconnect the power cord from the wall outlet during an electrical storm.
- 14 Take care of this unit so that no foreign objects and/or liquid drops inside this unit.
- 15 Do not attempt to modify or fix this unit. Contact qualified YAMAHA service personnel when any service is needed. The cabinet should never be opened for any reasons.
- 16 When not planning to use this unit for long periods of time (i.e. vacation), disconnect the AC power plug from the wall outlet.
- 17 Be sure to read the “TROUBLESHOOTING” section on common operating errors before concluding that this unit is faulty.
- 18 Before moving this unit, press STANDBY/ON to set this unit in the standby mode, and disconnect the AC power plug from the wall outlet.
- 19 **VOLTAGE SELECTOR (China and General models only)**
The VOLTAGE SELECTOR on the rear panel of this unit must be set for your local main voltage BEFORE plugging into the AC main supply.
Voltages are 110/120/220/240 V AC, 50/60 Hz.

This unit is not disconnected from the AC power source as long as it is connected to the wall outlet, even if this unit itself is turned off. This state is called the standby mode. In this state, this unit is designed to consume a very small quantity of power.

FREQUENCY STEP switch (China and General models only)

Because the interstation frequency spacing differs in different areas, set the FREQUENCY STEP switch (locating at the rear) according to the frequency spacing in your area.

North, Central and South America: 100 kHz/10 kHz

Other area: 50 kHz/9 kHz

Before setting this switch, disconnect the AC power plug of this unit from the AC outlet.

IMPORTANT

Please record the serial number of this unit in the space below.

MODEL:

Serial No.:

The serial number is located on the rear of the unit.

Retain this Owner's Manual in a safe place for future reference.

FOR CANADIAN CUSTOMERS

To prevent electric shock, match wide blade of plug to wide slot and fully insert.

This Class B digital apparatus complies with Canadian ICES-003.



CONTENTS

INTRODUCTION

FEATURES	2
GETTING STARTED	3
Checking the Package Contents	3
Battery Installation in the Remote Control	3
Battery Replacement	3
CONTROLS AND FUNCTIONS	4
Front Panel	4
Remote Control	6
Using the Remote Control	7
Display	8
Rear Panel	9

PREPARATION

SPEAKER SETUP	10
Speakers to Be Used	10
Speaker Placement	10
CONNECTIONS	11
Before Connecting Components	11
Connecting Audio Components	12
Connecting an External Decoder	12
Connecting Video Components	14
Connecting Speakers	16
IMPEDANCE SELECTOR Switch	18
Connecting the Power Supply Cords	18
ADJUSTING THE SPEAKER BALANCE	19
Before You Start Adjusting	19
Using the Test Tone	19

BASIC OPERATION

PLAYING A SOURCE	21
Input Modes and Indications	23
Selecting a DSP Program	24
Canceling the Sound Effect (turning off the effect speakers)	25
TUNING	26
Connecting the Antennas	26
Automatic Tuning	27
Manual Tuning	27
Automatic Preset Tuning (for FM stations only)	28
Manual Preset Tuning	29
To Recall a Preset Station	29
Exchanging Preset Stations	30
RECORDING A SOURCE	31

ADVANCED OPERATION

SET MENU	32
Adjusting the Items on the SET MENU	32
1 SPEAKER SET (speaker mode settings)	33
2 HP TONE CTRL (headphone tone control)	34
3 I/O ASSIGN	34
4 INPUT MODE (initial input mode)	35
5 DOLBY D. SET (Dolby Digital set)	35
6 DTS SET (DTS LFE level)	36
7 SP DLY TIME (center delay)	36
8 DISPLAY SET	36
9 MEM. GUARD (memory guard)	36
DELAY TIME AND SPEAKER OUTPUT	
LEVELS	37
Delay Time	37
Sound Output Level of the Center, Right Rear and Left Rear Speakers, and Subwoofer	37
Adjusting Method	38
SLEEP TIMER	39
Setting the SLEEP Timer	39
Canceling the SLEEP Timer	39
PRESET REMOTE CONTROL	40
Component Selector Buttons	40
Controlling the Components Connected to This Unit	40
Description of Each Mode	41
Setting the Manufacturer Code	45
Returning to the Factory Setting	46
SOUND FIELD PROGRAM	47
Hi-Fi DSP Programs	47
CINEMA DSP Programs	47

APPENDIX

TROUBLESHOOTING	50
SPECIFICATIONS (HTR-5450)	54
SPECIFICATIONS (HTR-5440)	55
GLOSSARY	56
INDEX	58



FEATURES

5-Channel Power Amplification

- ◆ Minimum RMS Output
(0.06% THD, 20 Hz – 20 kHz)

HTR-5450

[U.S.A. and Canada models]

Main: 80 W + 80 W (8 Ω)

Center: 80 W (8 Ω)

Rear: 80 W + 80 W (8 Ω)

[Australia, Singapore, China and General models]

Main: 70 W + 70 W (8 Ω)

Center: 70 W (8 Ω)

Rear: 70 W + 70 W (8 Ω)

HTR-5440

Main: 65 W + 65 W (8 Ω)

Center: 65 W (8 Ω)

Rear: 65 W + 65 W (8 Ω)

- ◆ Maximum Power (EIAJ)
(10% THD, 1 kHz)

HTR-5450

[China and General models]

Main: 100 W + 100 W (8 Ω)

Center: 100 W (8 Ω)

Rear: 100 W + 100 W (8 Ω)

HTR-5440

[China and General models]

Main: 95 W + 95 W (8 Ω)

Center: 95 W (8 Ω)

Rear: 95 W + 95 W (8 Ω)

Multi-mode Digital Sound Field Processing

- ◆ DTS Decoder
- ◆ Dolby Pro Logic Decoder
- ◆ Dolby Digital Decoder
- ◆ Hi-Fi DSP
- ◆ CINEMA DSP: Combination of YAMAHA DSP Technology and Dolby Digital, Dolby Pro Logic or DTS
- ◆ Virtual CINEMA DSP
- ◆ SILENT CINEMA

Sophisticated FM/AM Tuner

- ◆ 40-Station Random Access Preset Tuning
- ◆ Automatic Preset Tuning
- ◆ Preset Station Shifting Capability (Preset Editing)

Other Features

- ◆ 96-kHz/24-bit D/A Converter **HTR-5450 only**
- ◆ “SET MENU” which Provides You with 9 Items for Optimizing This Unit for Your Audio/Video System
- ◆ Test Tone Generator for Easier Speaker Balance Adjustment
- ◆ 6-Channel External Decoder Input for Other Future Formats
- ◆ Video Signal Input and Output Capability (Including S Video Connections) **HTR-5450 only**
- ◆ Optical and Coaxial Digital Signal Input Jacks
- ◆ SLEEP Timer
- ◆ Remote Control with Preset Manufacturer Codes

- This document is the Owner’s Manual for both the HTR-5450 and HTR-5440. For details on various functions unique to each model, see the descriptions given for each model name. Illustrations for the HTR-5450 are used for common functions.
-  indicates a tip for your operation.
- Some operations can be performed by using either the buttons on the main unit or on the remote control. In cases when the button names differ between the main unit and the remote control, the button name on the remote control is given in parentheses in this manual.



Manufactured under license from Dolby Laboratories.

“Dolby”, “AC-3”, “Pro Logic” and the double-D symbol are trademarks of Dolby Laboratories. Confidential Unpublished Works. ©1992-1997 Dolby Laboratories, Inc. All rights reserved.



Manufactured under license from Digital Theater Systems, Inc. US Pat. No. 5,451,942 and other world-wide patents issued and pending. “DTS” and “DTS Digital Surround” are trademarks of Digital Theater Systems, Inc. Copyright 1996 Digital Theater Systems, Inc. All Rights Reserved.



GETTING STARTED

Checking the Package Contents

Check that the following items are included in your package.

Remote control

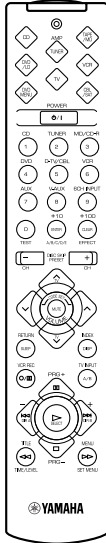

Batteries (AAA, R03, UM-4 type)

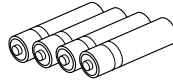

AM loop antenna



Indoor FM antenna
(U.S.A., Canada, China and
General models)

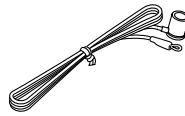

Quick reference card

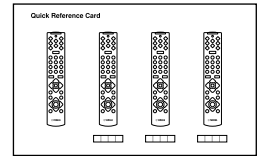

(Australia and
Singapore models)

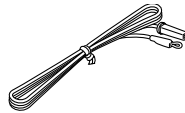

Connection guide

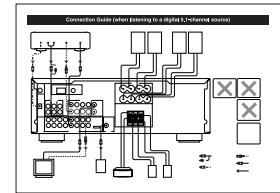

Battery Installation in the Remote Control

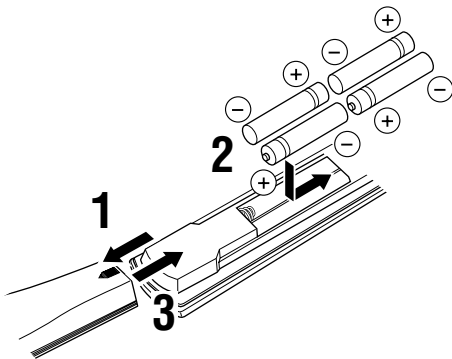

Battery Replacement

If the remote control operates only when it is close to the unit, the batteries are weak. Replace all the batteries with new ones.

Be sure to replace the batteries within about two minutes. If it takes longer than two minutes, the codes preset for the remote control will return to the factory settings.

Notes

- Use only AAA, R03 or UM-4 batteries for replacement.
- Be sure the battery polarity is correct. (See the illustration inside the battery compartment.)
- Remove the batteries if the remote control will not be used for an extended period of time.
- If the batteries have leaked, dispose of them immediately. Avoid touching the leaked material or letting it come into contact with clothing, etc. Clean the battery compartment thoroughly before installing new batteries.

1 Turn the remote control over and slide the battery compartment cover in the direction of the arrow.

2 Insert the batteries (AAA, R03 or UM-4 type) according to the polarity markings on the inside of the battery compartment.

3 Close the battery compartment cover.



CONTROLS AND FUNCTIONS

Front Panel

HTR-5450

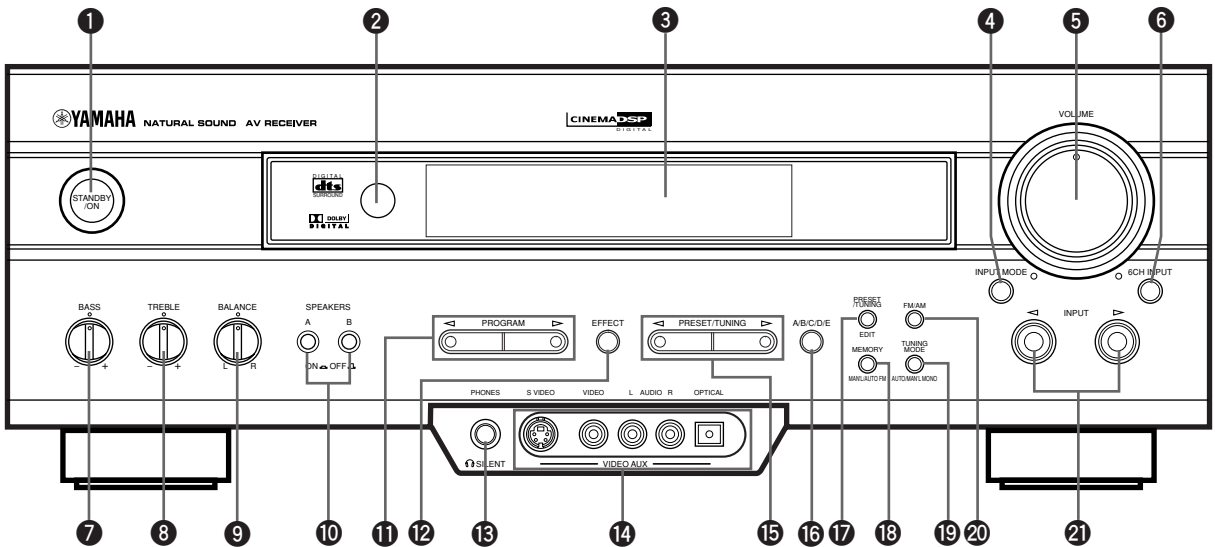

HTR-5440

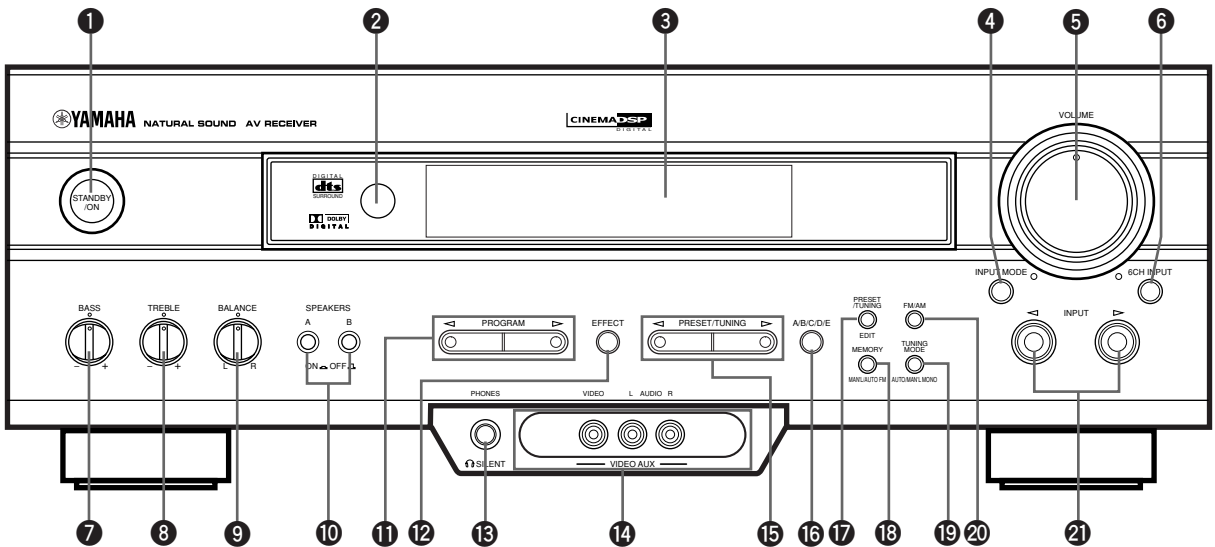

1 STANDBY/ON

Press this switch to turn on the power of this unit or to set this unit in the standby mode. Before turning the power on, set the volume at the minimum level.

Standby mode

In this mode, this unit consumes a very small quantity of power to receive infrared-signals from the remote control.

2 Remote control sensor

This receives signals from the remote control.

3 Display

This shows various information.

4 INPUT MODE

Press this button to select the input mode among AUTO, DTS and ANALOG for the sources that send two or more types of signals to this unit.

5 VOLUME

Turn this control to turn up or down the volume.

6 6CH INPUT

Press this button to select the source connected to the 6CH INPUT jacks. The source selected by pressing 6CH INPUT takes priority over the source selected with INPUT ◀/▶ (or the input selector buttons on the remote control).

7 BASS

Turn this control clockwise to increase or counterclockwise to decrease the low-frequency response.

8 TREBLE

Turn this control clockwise to increase or counterclockwise to decrease the high-frequency response.

Note

- If you increase or decrease the high-frequency or the low-frequency sound to an extreme level, the tonal quality from the center and rear speakers may not match that of the left and right main speakers.

9 BALANCE

This control is only effective for the sound from the main speakers.

Turn the control to adjust the balance of the output volume from the right and left main speakers to compensate for sound imbalance caused by the speaker location or listening room conditions.

10 SPEAKERS A/B

Set A or B (or both A and B) to the ON position for the main speaker system (connected to this unit) that you want to use. Set the button(s) to the OFF position for the main speaker system that you don't want to use.

11 PROGRAM ◀/▶

Press ◀ or ▶ to select a DSP program when the effect speakers (center and rear) are turned on. The name of the selected program appears on the display.

12 EFFECT

Press this button to turn on or off the effect speakers (center and rear). If you turn them off, all Dolby Digital and DTS audio signals except for the LFE channel are directed to the right and left main speakers. In that case, the output levels of the right and left speakers may not match.

13 PHONES jack

Connect the headphones to the PHONES jack so that this unit outputs audio signals for private listening.

When listening with headphones privately, set both SPEAKERS A/B to the OFF position.

14 VIDEO AUX jacks

Connect an auxiliary audio or video input source such as a game console or camcorder to these jacks. To reproduce source signals from these jacks, select V-AUX as the input source.

15 PRESET/TUNING ◀/▶

When “>” appears on the display:

This button is used to select a preset station number (1 to 8). Press ◀ to select a lower and ▶ to select a higher preset station number.

When “>” goes off from the display:

This button is used for tuning. Press ◀ to tune in to lower frequencies, and ▶ to tune in to higher frequencies.

16 A/B/C/D/E

Press this button to select one of 5 preset station groups (A to E).

17 PRESET/TUNING (EDIT)

Press this button to turn on or off “>” on the display and switch the function between for storing a broadcasting station (preset tuning) and for tuning. This button is also used to exchange the assignment of two preset stations with each other.

18 MEMORY (MAN'L/AUTO FM)

Press this button to store the broadcasting stations. Hold down this button for more than 3 seconds to begin automatic preset tuning (for FM stations only).

19 TUNING MODE (AUTO/MAN'L MONO)

Press this button to switch the tuning mode between automatic and manual. To use the automatic tuning method, press this button so that the “AUTO” indicator lights up on the display. To use the manual tuning method, press this button so that the “AUTO” indicator goes off.

20 FM/AM

Press this button to switch the reception band between FM and AM.

21 INPUT ◀/▶

Press these buttons to select the input source (DVD, AUX, MD/CD-R, TUNER, CD, V-AUX, VCR, D-TV/CBL) that you want to listen to or watch. The name of the selected input source appears on the display.

Remote Control

This section describes basic operation of this unit with the remote control. First, press AMP(TUNER) on the component selector. Refer to “PRESET REMOTE CONTROL” for full details.

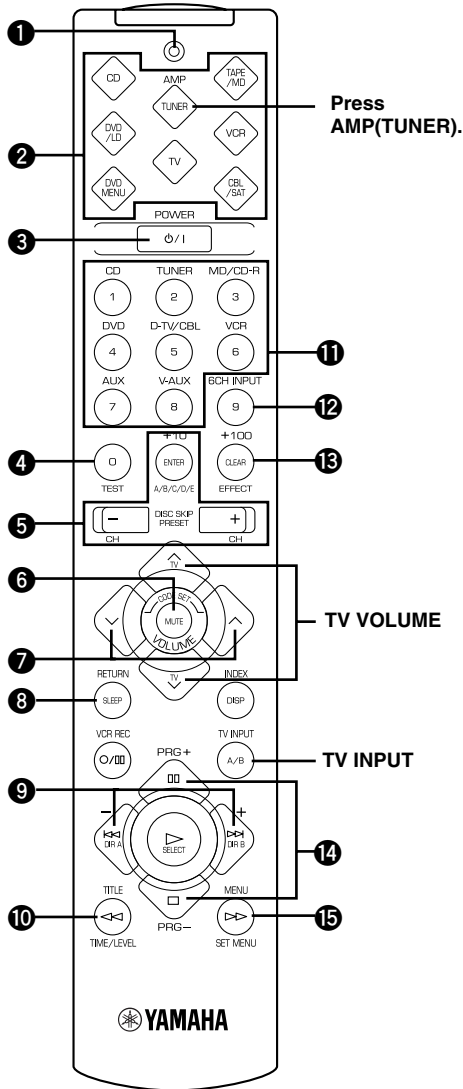

1 Indicator

This flashes in red when pressing a button on the remote control. If it flashes rapidly several times, press the selected button again.

2 Component selector buttons

Press one of these buttons which corresponds to the component you want to control with the remote control. (The proper code must be set for your component. Refer to “Setting the Manufacturer Code”.) When the component selector button has been pressed, the remote control is set to that component operation mode.

3 POWER

Each time you press this button, the unit switches between the power on and standby mode.

4 TEST

Press this button to output the test tone for each speaker.

5 A/B/C/D/E, PRESET +/-

These buttons are used to select a preset station.

A/B/C/D/E: To select one of a group (A to E) of preset stations

PRESET +/-: To select a preset station number (1 to 8)

6 MUTE

Press this button to mute the sound. To cancel mute, press this button again.

7 VOLUME

These buttons are used to adjust the volume level.

^: To turn up the volume

v: To turn down the volume

8 SLEEP

Press this button to set the SLEEP timer.

9 +/-

These buttons adjust the settings of the SET MENU and TIME/LEVEL mode.

10 TIME/LEVEL

Press this button to select the items in the TIME/LEVEL mode.

11 Input selector buttons

These buttons select the input source.

CD: To play a CD

TUNER: To listen to an FM or AM broadcast

MD/CD-R: To play an MD or CD recorder (or tape deck)

DVD: To play a DVD

D-TV/CBL: To watch a TV/digital TV or cable TV

VCR: To play a video cassette

AUX: To use another audio component

V-AUX: To use another audio/video component

12 6CH INPUT

Press this button to play a source connected to the 6CH INPUT jacks.

Using the Remote Control

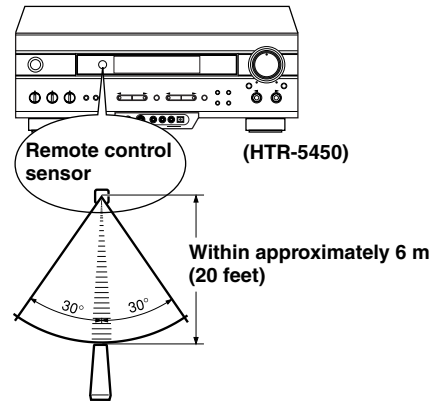

The remote control transmits a directional infrared beam. Be sure to aim the remote control directly at the infrared sensor during operation. When the sensor is covered or there is a large object between the remote control and the sensor, the sensor cannot receive signals. The sensor may not be able to receive signals properly when it is exposed to direct sunlight or a strong artificial light (such as a fluorescent or strobe light). In this case, change the direction of the light or reposition the unit to avoid direct lighting.

Notes

- Handle the remote control with care.
- Do not spill water, tea or other liquids on the remote control.
- Do not drop the remote control.
- Do not leave or store the remote control in the following conditions:
 - high humidity or temperature such as near a heater, stove or bath;
 - dusty places; or
 - extremely low temperature.

13 EFFECT

Press this button to turn on or off the effect speakers (center and rear).

14 PRG+, PRG–

Press these buttons to select a DSP program.

Once you press SET MENU, these buttons are used for selecting the SET MENU item.

15 SET MENU

Press this button to select the items in the SET MENU.

Display

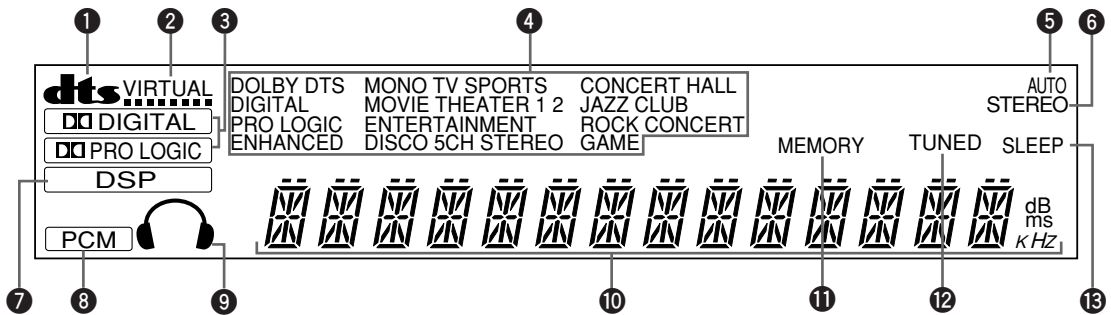

1 dts indicator

The “dts” indicator lights up when the built-in DTS decoder is turned on.

2 VIRTUAL indicator

This lights up when using Virtual CINEMA DSP.

3 DIGITAL and PRO LOGIC indicators

“DIGITAL” lights up when the built-in Dolby Digital decoder is on and the signals of the selected source are encoded with Dolby Digital. “PRO LOGIC” lights up when the built-in Dolby Pro Logic decoder is on.

4 DSP program indicators

This indicates the name of the selected DSP program.

5 AUTO indicator

This lights up when the unit is in the automatic tuning mode.

6 STEREO indicator

This lights up when an FM stereo broadcast with sufficient signal strength is being received.

7 DSP indicator

“DSP” lights up when the built-in digital sound field processor is on.

8 PCM indicator

This lights up when this unit is reproducing PCM (pulse code modulation) digital audio signals.

9 Headphones indicator

This lights up when headphones are connected.

10 Multi-information display

This display shows various information: for example the name of the selected input source and the various settings during adjustment with the SET MENU. The current station frequency and band (FM or AM) also appear when the tuner is selected as the input source.

11 MEMORY indicator

This flashes for about 5 seconds after pressing MEMORY. During this period, the displayed station can be stored in the memory.

12 TUNED indicator

This lights up when this unit tunes in to a station.

13 SLEEP indicator

This lights up while the built-in SLEEP timer is on.

Rear Panel

INTRODUCTION

HTR-5450

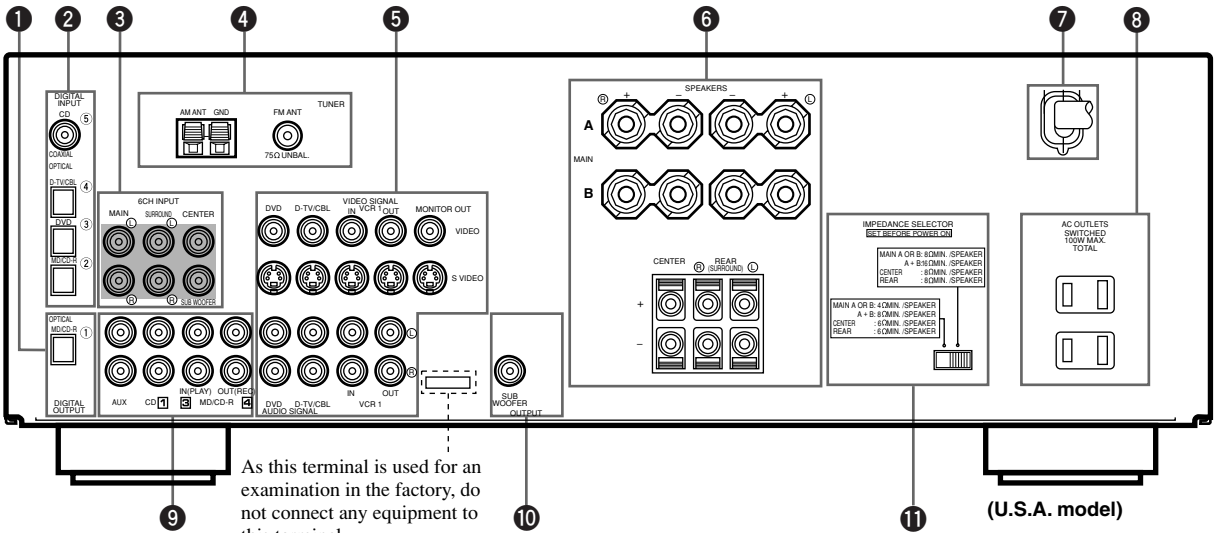

HTR-5440

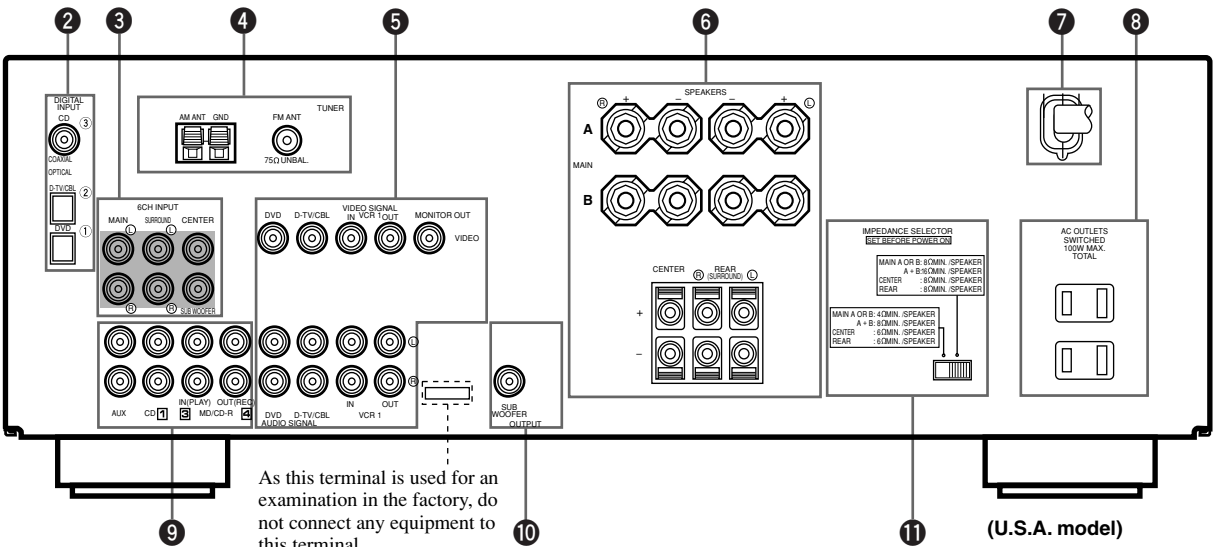

1 DIGITAL OUTPUT jacks **HTR-5450 only**

2 DIGITAL INPUT jacks

3 6CH INPUT jacks

See pages 12 and 13 for connection information.

4 Antenna input terminals

See page 26 for connection information.

5 Video component jacks

See pages 14 and 15 for connection information.

6 Speaker terminals

See pages 16 and 17 for connection information.

7 AC power cord

Connect to a power outlet.

8 AC OUTLET(S)

Use these outlets to supply power to your other audio/video components (see page 18).

9 Audio component jacks

See pages 12 and 13 for connection information.

10 SUBWOOFER jack

See page 17 for connection information.

11 IMPEDANCE SELECTOR switch

Use this switch to match the amplifier output to your speaker impedance. Set this unit in the standby mode before you change the setting of this switch (see page 18).

China and General models only

FREQUENCY STEP switch

See page 26.

VOLTAGE SELECTOR

See page 18.

English



SPEAKER SETUP

Speakers to Be Used

This unit is designed to provide the best sound-field quality with a 5-speaker system, using main speakers, rear speakers and a center speaker. If you use different brands of speakers (with different tonal qualities) in your system, the tone of a moving human voice and other types of sound may not shift smoothly. We recommend that you use speakers from the same manufacture to ensure even tonal quality.

The main speakers are used for the main source sound plus the effect sounds. They will probably be the speakers from your present stereo system. The rear speakers are used for the effect and surround sounds, and the center speaker is for the center sounds (dialog, vocals, etc.). If for some reason it is not practical to use a center speaker, you can do without it. Best results, however, are obtained with the full system.

The main speakers should be high-performance models and have enough power-handling capacity to accept the maximum output of your audio system. The other speakers do not have to be equal to the main speakers. For precise sound localization, however, it is ideal to use high-performance models that can reproduce sounds over the full range for the center speaker and the rear speakers.

■ Use of a subwoofer expands your sound field

It is also possible to further expand your system with the addition of a subwoofer. The use of a subwoofer is effective not only for reinforcing bass frequencies from any or all channels, but also for reproducing the LFE (low frequency effect) channel with high fidelity when playing back a source encoded with Dolby Digital or DTS. The YAMAHA Active Servo Processing Subwoofer System is ideal for natural and lively bass reproduction.

Speaker Placement

Refer to the following diagram when you place the speakers.

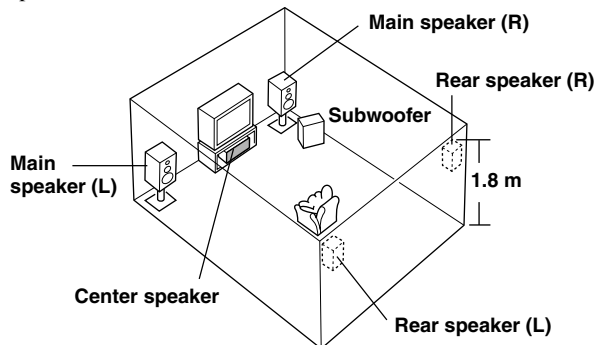

■ Main speakers

Place the right and left main speakers an equal distance from the ideal listening position. The distance of each speaker from each side of the TV monitor should be the same.

■ Rear speakers

Place these speakers behind your listening position, facing slightly inwards, nearly 1.8 m (approx. 6 feet) above the floor.

■ Center speaker

Align the front face of the center speaker with the front face of your TV monitor. Place the speaker as close to the monitor as possible, such as directly over or under the monitor and centrally between the main speakers.

Note

- If the center speaker is not used, the sound will be heard from the right and left main speakers. In that case, "CENTER SP" in the SET MENU is set to the NON position.

■ Subwoofer

The position of the subwoofer is not so critical, because low bass sounds are not highly directional. But it is better to place the subwoofer near the main speakers. Turn it slightly toward the center of the room to reduce the wall reflections.

CAUTION

Please use magnetically shielded speakers. Sometimes a video monitor may be adversely affected even when magnetically shielded speakers are used. Separate the speakers from the monitor if this happens.



CONNECTIONS

Before Connecting Components

CAUTION

Never connect this unit and other components to mains power until all connections between components have been completed.

Be sure all connections are made correctly, that is to say L (left) to L, R (right) to R, “+” to “+” and “-” to “-”. Some components require different connection methods and have different terminal names. Refer to the instructions for each component to be connected to this unit.

When you connect other YAMAHA audio components (such as a tape deck, MD recorder and CD player or changer), connect it to the jacks with the same number labels as **1**, **3**, **4** etc.

Use RCA-type pin plug cables for connecting audio/video components with the exception described later.

The input and output jacks for pin plugs can be distinguished as follows:

Yellow	video signals (composite)	
White	analog audio signals for the left channel	
Red	analog audio signals for the right channel	
	coaxial digital signals	

After completing all connections, check them again to make sure they are correct.

Connecting Audio Components

■ Connecting to digital jacks

This unit has digital jacks for direct transmission of digital signals through either coaxial or fiber optic cables. You can use the digital jacks to input PCM, Dolby Digital and DTS bitstreams. When you connect components to both the COAXIAL and OPTICAL jacks, priority is given to the input signals from the COAXIAL jack. All digital input jacks are acceptable for 96-kHz sampling digital signals.



- You can designate the input for each digital jack according to your component by using “3 I/O ASSIGN” in the SET MENU.
- **HTR-5450 only**
All digital input jacks are acceptable for 96-kHz sampling digital signals.
- **HTR-5440 only**
When making connections between the digital signal jacks, you should connect the components to the same-named analog audio signal jacks of this unit, because a digital signal cannot be recorded by a recording component connected to this unit.
- All digital signal input jacks are applicable to sampling frequencies of 32 kHz, 44.1 kHz and 48 kHz.

About the dust protection cap



Pull out the cap from the optical jack before you connect the fiber optic cable. Do not discard the cap. When you are not using the optical jack, be sure to put the cap back in place. This cap protects the jack from dust.

Note

- The OPTICAL jacks on this unit conform to the EIA standard. If you use a fiber optic cable that does not conform to this standard, this unit may not function properly.

■ Connecting a CD player



- The COAXIAL jack is available for a CD player which has coaxial digital output jack.
- When you connect a CD player to both the analog and digital jacks, priority is given to the input signals from the digital jack.

■ Connecting an MD recorder, CD recorder or tape deck



- **HTR-5450 only**
When you connect your recording component to both the analog and digital input and output jacks, the priority is given to the digital signal.
- **HTR-5440 only**
Connect the analog input/output jack of your recording component to the AUDIO jacks.

Notes

- When you connect a recording component to this unit, keep its power on while using this unit. If the power is off, this unit may distort the sound from other components.
- **HTR-5450 only**
Since digital output and analog output (REC OUT) are independent of each other, the analog signal is output only to the analog jack, while the digital signal is output only to the digital jack.

Connecting an External Decoder

This unit is equipped with 6 additional input jacks (left and right MAIN, CENTER, left and right SURROUND and SUBWOOFER) for discrete multi-channel input from an external decoder, sound processor or pre-amplifier.

Connect the output jacks on your external decoder to the 6CH INPUT jacks. Be sure to match the left and right outputs to the left and right input jacks for the main and surround channels.

Notes

- When you select 6CH INPUT as the input source, this unit automatically turns off the digital sound field processor, and you cannot listen to DSP programs.
- When you select 6CH INPUT as the input source, changing items of “1 SPEAKER SET” in the SET MENU is not affected (except “MAIN LVL”).

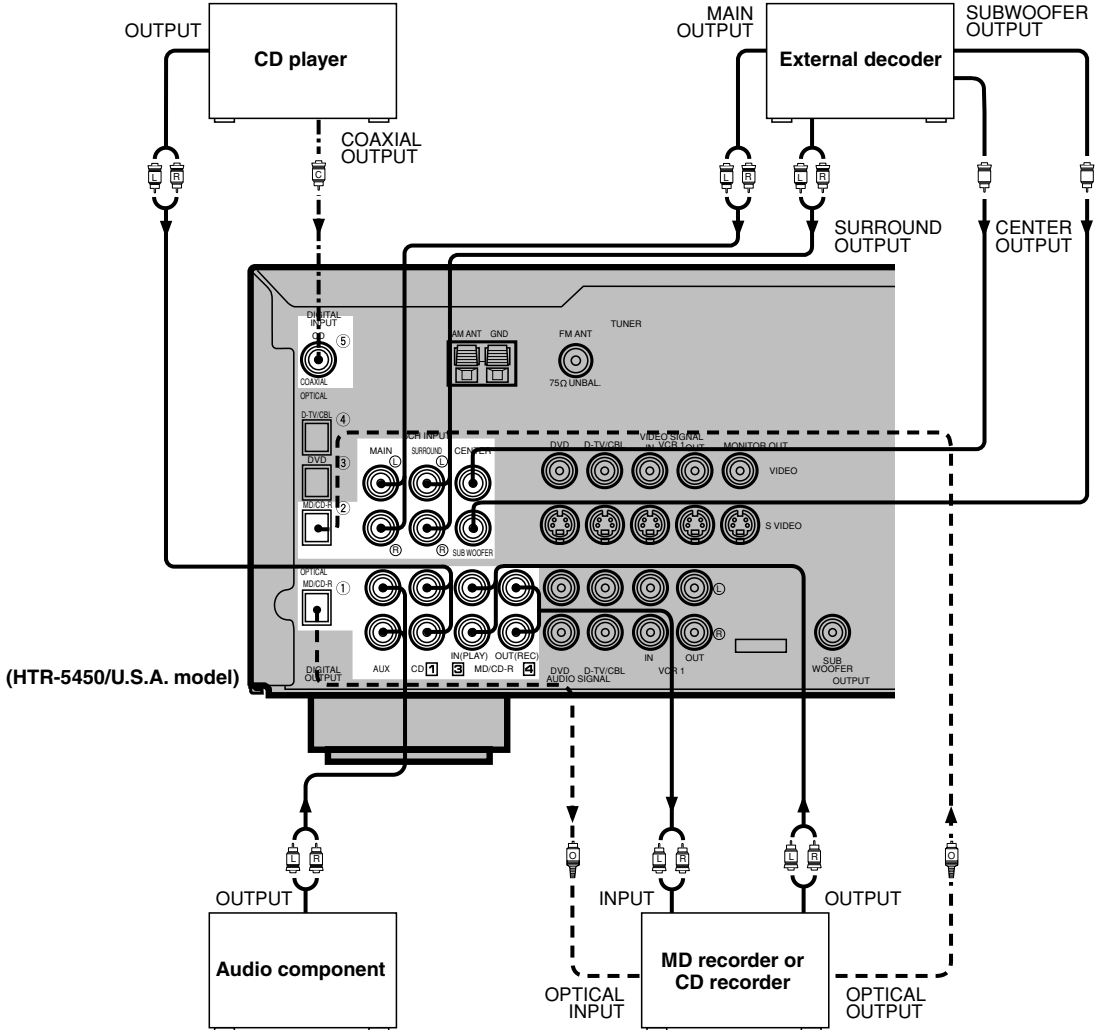

(HTR-5450/U.S.A. model)

- indicates signal direction
- (L/R) indicates left analog cables
- (L/R) indicates right analog cables
- - - (C) indicates optical cables
- - - (C) indicates coaxial cables

Connecting Video Components

■ Audio signal jacks

Be sure to connect the right channel (R), left channel (L), input (IN) and output (OUT) properly.

■ Video signal jacks

Be sure to connect the input (IN) and output (OUT) properly.

■ S VIDEO jacks **HTR-5450 only**

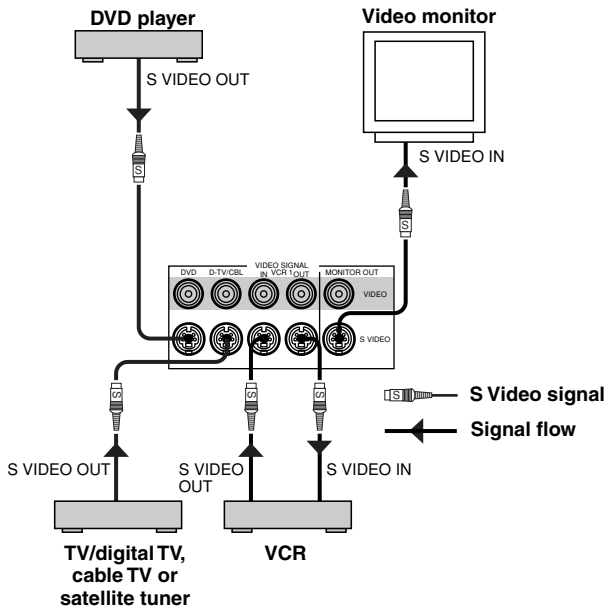

If your video component has “S” (high-resolution) video jacks, they can be connected to this unit’s S VIDEO jacks. Otherwise, connect the composite video jacks of your video component to this unit’s composite video jacks.

Notes

- Use a special S VIDEO cable (commercially available) for the S VIDEO connection.
- If video signals are input from both the S VIDEO input and composite input jacks, the signals will be directed to their respective output jacks.

■ VIDEO AUX jacks (on the front panel)

These jacks are used to connect any video input source such as a game console or camcorder to this unit.

HTR-5450

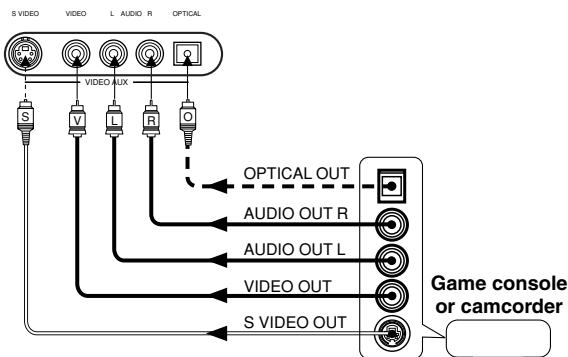

HTR-5440

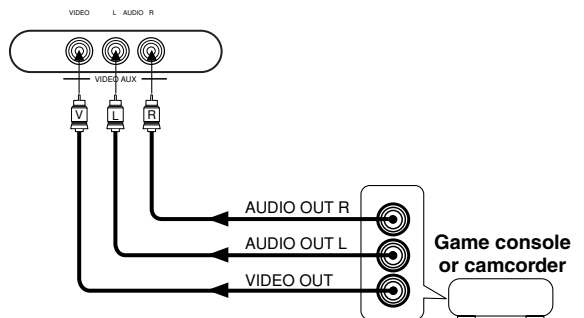

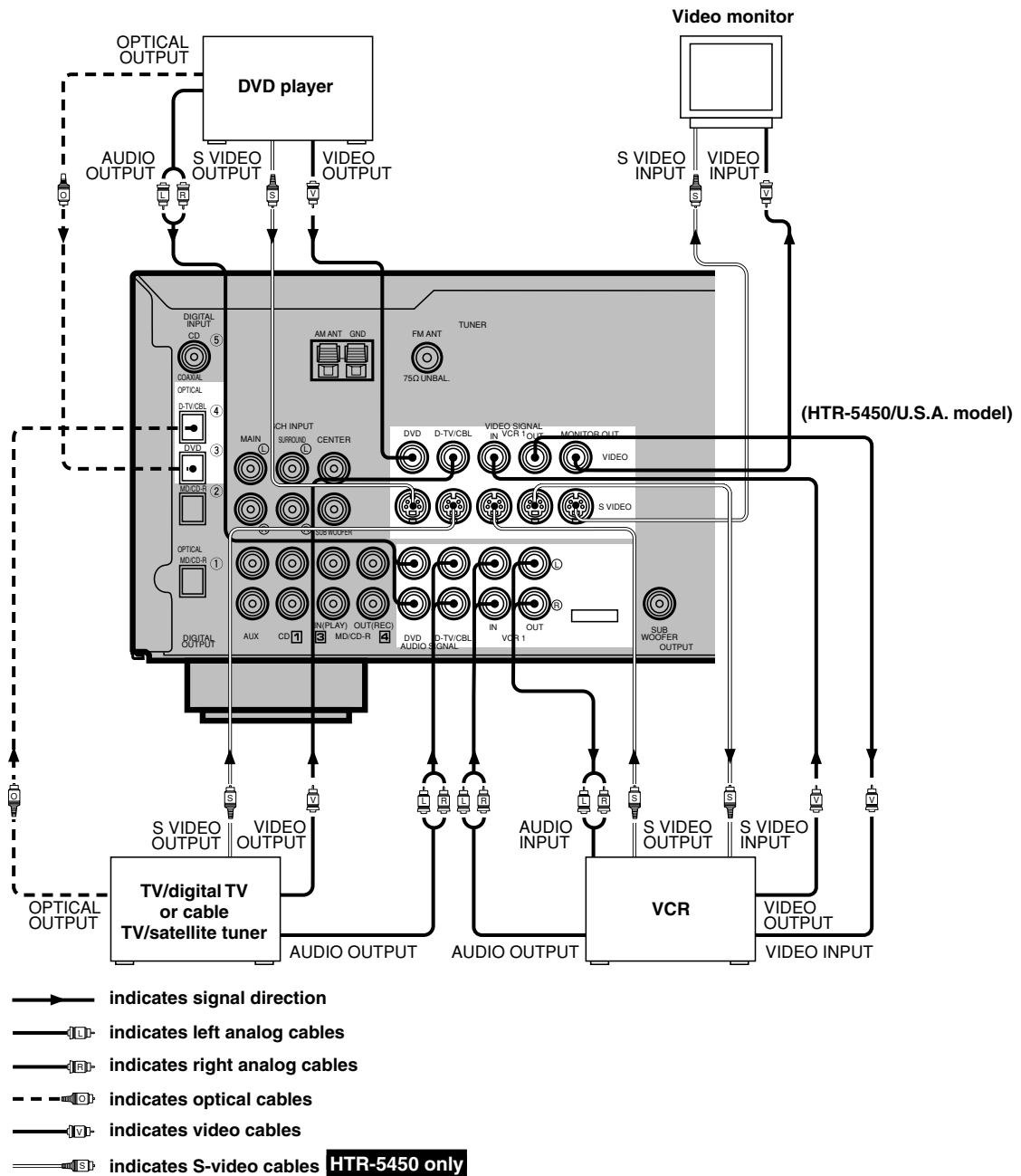

When using an LD player

Connect the LD player output to the DVD jack.

If the LD player has an OPTICAL digital output jack, connect it to this unit's OPTICAL DVD jack. If it has analog jacks, connect it to the analog DVD jacks. If it has an "RF OUTPUT jack" to output a Dolby Digital RF signal (AC-3), use a commercially available RF demodulator and connect it to the OPTICAL DVD jack.

If connecting a DVD player and an LD player, connect the LD player to the digital input jack (ex. D-TV/CBL) or the analog input jack (D-TV/CBL or VCR 1). For details on connections and operations, refer to the operation instructions for the LD player.

Note that this unit's remote control can be used to operate the LD player by setting the corresponding manufacturer code for the DVD/LD mode.

Connecting Speakers

Be sure to connect the right channel (R), left channel (L), “+” (red) and “-” (black) properly. If the connections are faulty, no sound will be heard from the speakers, and if the polarity of the speaker connections is incorrect, the sound will be unnatural and lack bass.

CAUTION

- Use speakers with the specified impedance shown on the rear panel of this unit.
- Do not let the bare speaker wires touch each other and do not let them touch any metal part of this unit. This could damage the unit and/or speakers.

Speaker cables

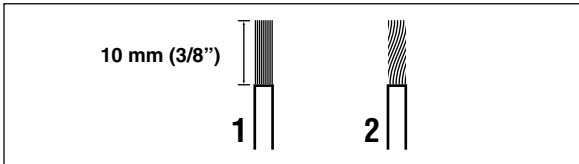

- 1** Remove approx. 10 mm (3/8”) of insulation from each of the speaker cables.
- 2** Twist the exposed wires of the cable together to prevent short circuits.

Connecting to the MAIN SPEAKERS terminals

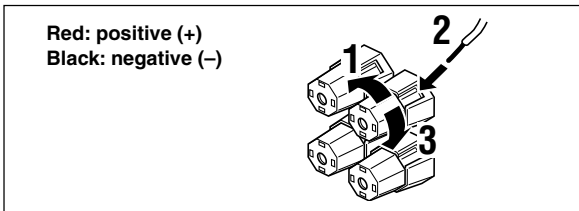

Red: positive (+)
Black: negative (-)

- 1** Unscrew the knob.
- 2** Insert one bare wire into the hole in the side of each terminal.
- 3** Tighten the knob to secure the wire.

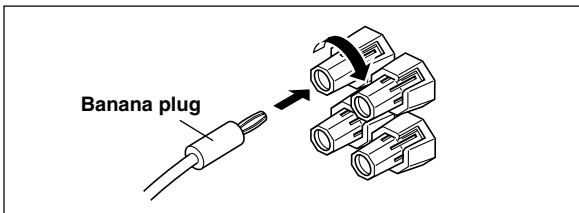

Banana plug



(U.S.A., Canada, Australia, China and General models only)

- Banana plug connections are also possible. First, tighten the knob and then insert the banana plug connector into the end of the corresponding terminal.

Connecting to the REAR and CENTER SPEAKERS terminals

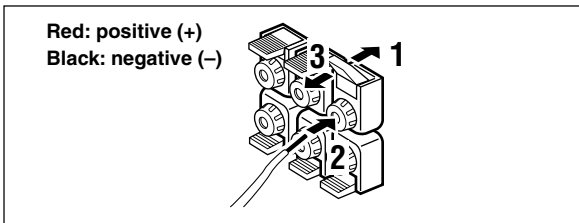

Red: positive (+)
Black: negative (-)

- 1** Open the tab.
- 2** Insert one bare wire into the hole of each terminal.
- 3** Return the tab to secure the wire.



(U.S.A., Canada, Australia, China and General models only)

- Banana plug connections are also possible. First, open the tab and then insert the banana plug connector into the end of the corresponding terminal.

Main speaker terminals

One or two speaker systems can be connected to these terminals. If you use only one speaker system, connect it to either of the SPEAKERS A or B terminals.

Rear speaker terminals

A rear speaker system can be connected to these terminals.

Center speaker terminals

A center speaker can be connected to these terminals.

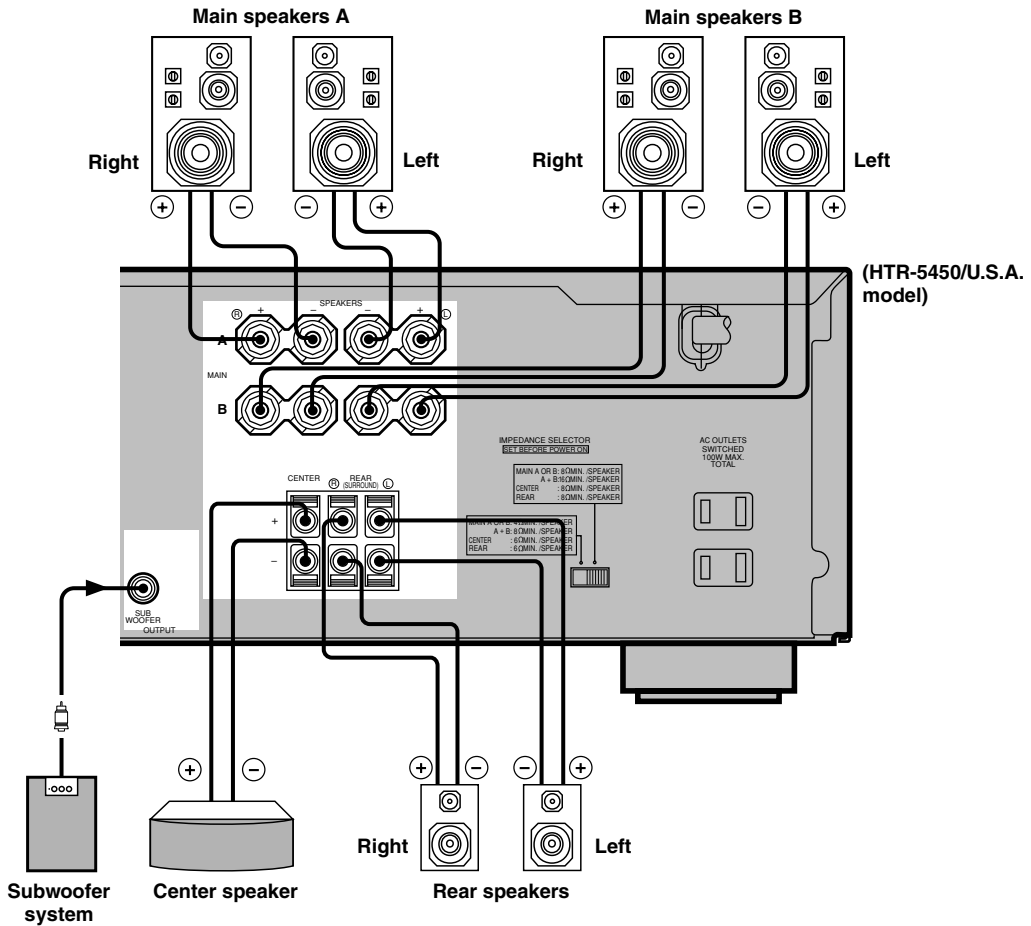

PREPARATION

■ Subwoofer connection

When using a subwoofer with built-in amplifier, including the YAMAHA Active Servo Processing Subwoofer System, connect the input jack of the subwoofer system to this jack. Low bass signals distributed from the main, center and/or rear channels are directed to this jack. (The cut-off frequency of this jack is 90 Hz.) The LFE (low-frequency effect) signals generated when Dolby Digital or DTS is decoded are also directed if they are assigned to this jack.

Notes

- Adjust the subwoofer volume according to the operation instructions for the subwoofer. (Fine adjustment is possible using this unit's output level control of the effect speakers.)
- Depending on the settings of "1 SPEAKER SET", "LFE LEVEL (5 DOLBY D. SET)" and "6 DTS SET" in the SET MENU, some signals may not be output from the SUBWOOFER jack.

English

IMPEDANCE SELECTOR Switch

WARNING

Do not change the IMPEDANCE SELECTOR switch setting while the power to this unit is on, otherwise the unit may be damaged.

If this unit fails to turn on when STANDBY/ON (or POWER) is pressed, the IMPEDANCE SELECTOR switch may not be fully slid either position. If so, slide the switch to either position fully when this unit is in the standby mode.

Select the right or left position according to the impedance of speakers in your system. Be sure to move this switch only when this unit is in the standby mode.

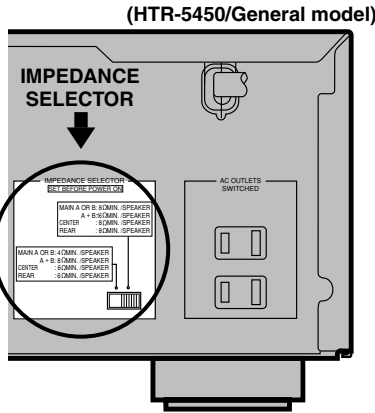

Switch position	Speaker	Impedance level
Left	Main	If you use one set of main speakers, the impedance of each speaker must be 4 Ω or higher. If you use two sets of main speakers, the impedance of each speaker must be 8 Ω or higher.
	Center	The impedance must be 6 Ω or higher.
	Rear	The impedance of each speaker must be 6 Ω or higher.
Right	Main	If you use one set of main speakers, the impedance of each speaker must be 8 Ω or higher. If you use two sets of main speakers, the impedance of each speaker must be 16 Ω or higher. [Canada model only] The impedance of each speaker must be 8 Ω or higher.
	Center	The impedance must be 8 Ω or higher.
	Rear	The impedance of each speaker must be 8 Ω or higher.

VOLTAGE SELECTOR (China and General models only)

The VOLTAGE SELECTOR on the rear panel of this unit must be set for your local main voltage BEFORE plugging into the AC main supply. Voltages are 110/120/220/240 V AC, 50/60 Hz.

Connecting the Power Supply Cords

After completing all connections, connect the AC power cord to an AC power outlet. Disconnect the AC power cord if you will not use this unit for a long period of time.

AC OUTLETS (SWITCHED)

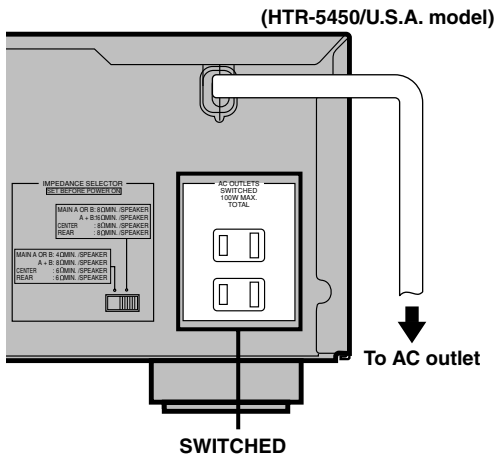

U.S.A., Canada, Singapore, China and

General models 2 OUTLETS

Australia model 1 OUTLET

Use these outlets to connect the power cords only from your audio/video components to this unit. The power to the AC OUTLET(S) is controlled by this unit's STANDBY/ON (or POWER). These outlets will supply power to any connected component whenever this unit is turned on. The maximum power (total power consumption of components) that can be connected to the AC OUTLET(S) is 100 W (50 W for China and General models).



ADJUSTING THE SPEAKER BALANCE

This procedure lets you adjust the sound output level balance between the main, center and rear speakers by using the built-in test tone generator. When this adjustment is performed, the sound output level heard at the listening position will be the same from each speaker. This is important for the best performance of the digital sound field processor, the Dolby Pro Logic decoder, Dolby Digital decoder and DTS decoder.

Note

- Since this unit cannot enter the test mode while headphones are connected to this unit, be sure to unplug the headphones from the PHONES jack when using the test tone.

Before You Start Adjusting

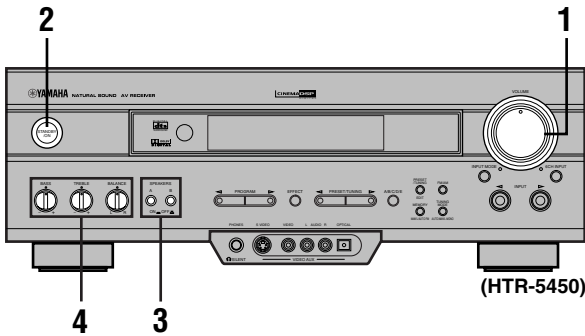

- 1 Set the volume at the minimum level.**

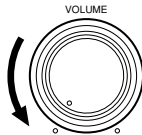

- 2 Turn the power on.**



- 3 Press SPEAKERS A or B to select the main speakers to be used.**

If you use two main speaker systems, press both A and B.

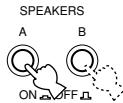

- 4 Set BASS, TREBLE and BALANCE to the center position.**

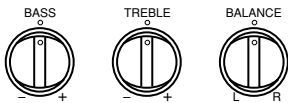

Using the Test Tone

The adjustment of each speaker sound output level should be performed at your listening position with the remote control.

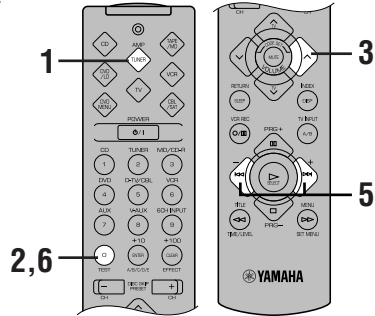

- 1 Press AMP(TUNER) on the component selector.**



- 2 Press TEST.**

“TEST LEFT” appears on the display.



TEST LEFT

- 3 Turn up the volume.**

You will hear a test tone (like pink noise) from each speaker for about two seconds in following order: left main speaker, center speaker, right main speaker, right rear speaker and left rear speaker. The display changes as shown below.

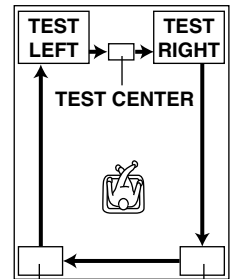
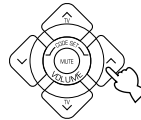

TEST L SUR. TEST R SUR.

Notes

- If the test tone cannot be heard, turn down the volume, set the unit in the standby mode and check the speaker connections.
- If the test tone cannot be heard from the center speaker, check the setting of “CENTER SP” in the SET MENU.

- 4** Adjust **BALANCE** on the front panel so that the sound output level of the right main speaker and the left main speaker is the same.

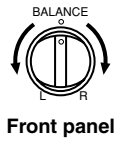

Front panel

- 5** Press **-/+** repeatedly to adjust the output level of the speaker currently outputting the test tone so that it becomes almost the same as that of the main speakers.

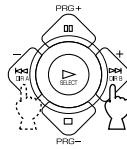

While adjusting, the test tone is heard from the selected speaker.

- 6** When the adjustment is complete, press **TEST**.

The test tone stops.



Notes

- If “CENTER SP” in the SET MENU is set to the NON position, the sound output level of the center speaker cannot be adjusted in step 5. The center channel sound is automatically output from the right and left main speakers.
- For details on adjusting the subwoofer speaker, refer to “DELAY TIME AND SPEAKER OUTPUT LEVELS” on page 37.
- After adjusting with the test tone, it is possible to adjust the speaker level to taste while listening to the playback of an actual source. Refer to “DELAY TIME AND SPEAKER OUTPUT LEVELS” on page 37.



- Once you have completed the adjustments, you can only adjust the overall volume level of your audio system by using **VOLUME** (or **VOLUME** (∧/∨)).
- If there is insufficient sound output from the center and rear speakers, you may decrease the main speaker output level by setting “MAIN LVL” in the SET MENU to “-10 dB”.

PLAYING A SOURCE

When using the remote control, press AMP(TUNER) on the component selector.

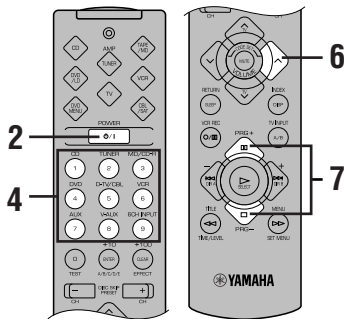
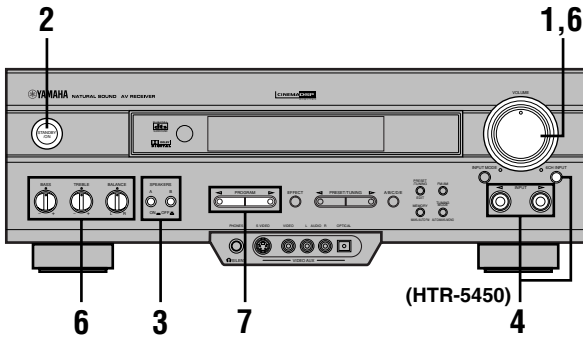

4 Select the desired input source with INPUT </> (or the input selector buttons). (Turn on the video monitor for video sources.)

The name of the selected input source appears on the display.

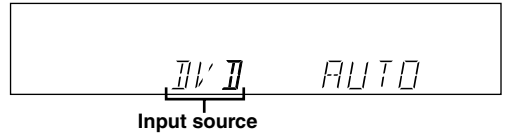
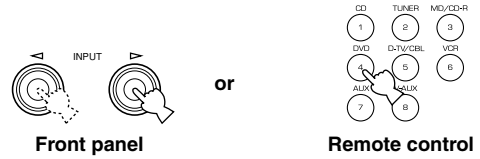

To select a source connected to the 6CH INPUT jacks

Press 6CH INPUT so that "6CH INPUT" appears on the display.

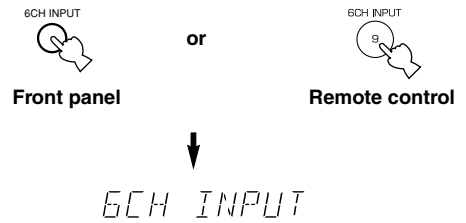

1 Set the volume at the minimum level.

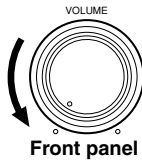

2 Turn the power on.

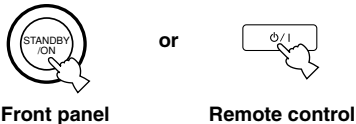

3 Press SPEAKERS A or B to select the main speakers to be used.

If you use two main speaker systems, press both A and B.

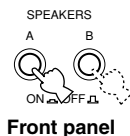

Notes

- An audio source can not be played if "6CH INPUT" appears. Press 6CH INPUT to turn off "6CH INPUT".
- If you select and play a video source when "6CH INPUT" appears, the playback result will be a video image from the video source and the sound from the audio source selected by using "6CH INPUT".



- The current input mode is also shown. Refer to "Input Modes and Indications" on page 23 for details.

5 Play the source.

Refer to the instructions for the source component (and “TUNING” for details).

Note

- When controlling an audio/video component (MD recorder, CD player, DVD player, tape deck, etc.) with the remote control, press one of the component selector buttons, (TAPE/MD, CD, DVD/LD, etc.), which corresponds to the component you want to control. Refer to “PRESET REMOTE CONTROL”.

6 Adjust the volume to the desired output level.

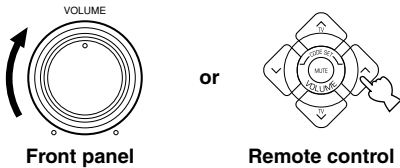

If desired, adjust BASS, TREBLE, BALANCE, etc. These controls are only effective for the sound from the main speakers.

- BASS controls the low-frequency response.
- TREBLE controls the high-frequency response.
- BALANCE adjusts the balance of the output volume from the right and left main speakers.

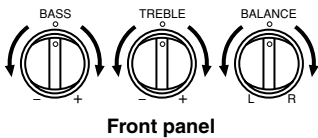

7 Use the digital sound field processor.

Refer to “Selecting a DSP Program”.

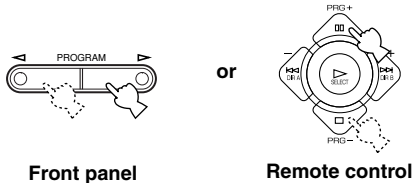

To mute the sound

Use this when you want to temporarily mute audio output.

Press MUTE on the remote control.

To restore the audio output to the previous volume level, press MUTE again.



Note

- During muting, “MUTE ON” appears on the display.

When you have finished using this unit

Press STANDBY/ON (or POWER) to set this unit in the standby mode.

Notes on the digital signal HTR-5450 only

The digital input jacks of this unit can also handle 96-kHz sampling digital signals. (To utilize this, use a source that supports 96-kHz sampling digital signals and set the player for digital output. Refer to the operation instructions for the player.) Note the following when a 96-kHz sampling digital signal is input to this unit:

- The following indication will appear on the display.

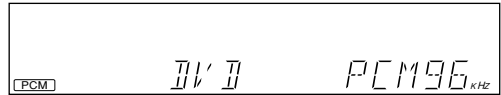

- DSP programs cannot be selected. Sound will be output as normal 2-channel stereo sound from only the left and right main speakers.

Note

- If “MAIN SP” in the SET MENU is set to SMALL and “BASS OUT” is set to SWFR or “BASS OUT” is set to BOTH, the sound is also output from the subwoofer.
- Adjustment of the speaker output level described on page 37 cannot be made (except the level of the subwoofer)

BGV (background video) function

The BGV function allows you to combine a video image from a video source with a sound from an audio source. (For example, you can listen to classical music while you are watching a video.) This function can only be controlled with the remote control.

Play a video source, and then select an audio source with the input selector buttons on the remote control. The BGV function does not work if you select the audio source with INPUT <|/> on the front panel.

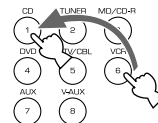

Input Modes and Indications

When using the remote control, press AMP(TUNER) on the component selector.

This unit comes with various input jacks. If your component is connected to more than one type of input jack, you can set the priority of the input signal.

Press INPUT MODE (or the input selector button that you have pressed to select the input source on the remote control) repeatedly until the desired input mode is shown on the display.

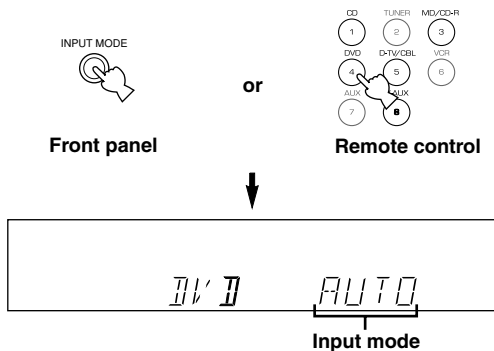

- AUTO:** In this mode, the input signal is automatically selected in the following order:
- 1) Dolby Digital or DTS signal
 - 2) Digital (PCM) signal
 - 3) Analog signal
- DTS:** In this mode, only the digital input signal encoded with DTS is selected even if another signal is input at the same time.
- ANALOG (ANLNG):** In this mode, only the analog input signal is selected even if a digital signal is input at the same time.

Notes

- If digital signals are input from both the COAXIAL and OPTICAL jacks, the digital signal from the COAXIAL jack is selected.
- When AUTO is selected, this unit automatically determines the type of signal. If this unit detects a Dolby Digital or DTS signal, the decoder automatically switches to the appropriate setting and reproduces 5.1 channel source.
- The sound output may be interrupted for some LD players and DVD players in the following situation:
When the input mode has been set to AUTO and a search is performed while playing the source encoded with a Dolby Digital or DTS signal, the sound may delay for a moment when playback is resumed.
- Depending on the LD player, playback may not be made when playing an LD that is not digitally recorded with the input mode set to AUTO. If this happens, set the input mode to ANALOG.

Notes on playing a source encoded with a DTS signal

- If the digital output data of the player has been processed in any way, you may not be able to perform DTS decoding even if you make a digital connection between this unit and the player.
- If you play a source encoded with a DTS signal and set the input mode to ANALOG, this unit reproduces the noise of an unprocessed DTS signal. When you want to play a DTS source, be sure to connect the source to a digital input jack and set the input mode to AUTO or DTS.
- If you switch the input mode to ANALOG while playing a source encoded with a DTS signal, this unit reproduces no sound.
- The following phenomena may occur if the input mode is set to AUTO when playing back a source encoded with DTS:
 - If you continue to play a source encoded with a DTS signal, this unit automatically switches to the “DTS-decoding” mode to prevent noise from being generated during subsequent operation. (The “**dts**” indicator lights up on the display.) The “**dts**” indicator may flash immediately after playback of a source encoded with a DTS signal has finished. Only a source encoded with a DTS signal can be played back while this indicator is flashing. (The indicator will flash for less than a minute.) If you want to play a normal PCM source soon, set the input mode back to AUTO.
 - The “**dts**” indicator may flash when a search or skip operation is performed. If this status continues for a certain length of time, the unit will automatically switch from the “DTS-decoding” mode to PCM digital signal input mode and the “**dts**” indicator will go out.

Selecting a DSP Program

You can enhance your listening experience by selecting a DSP program. Refer to “SOUND FIELD PROGRAM” for details about each program.



- Make sure that the sound effect is turned on (see page 25).

■ On the remote control

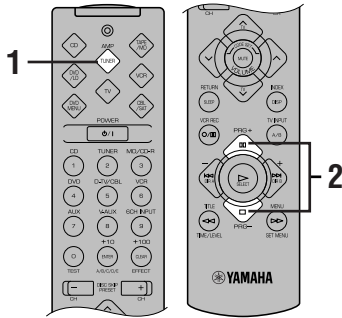

- 1** Press AMP(TUNER) on the component selector.



- 2** Press PRG+ or PRG– repeatedly to select the desired program.

The name of the selected program appears for a moment and the selected DSP program indicator lights up on the display.

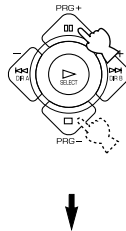

DSP program name

■ On the front panel

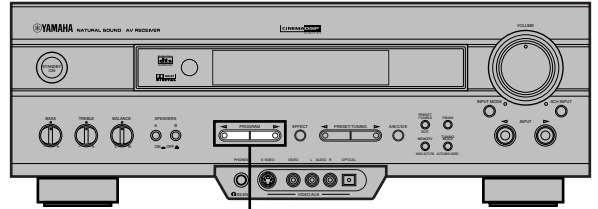

(HTR-5450)

PROGRAM ◀▶

Press PROGRAM ◀ or ▶ repeatedly to select the desired program.

The name of the selected program appears for a moment and the selected DSP program indicator lights up on the display.

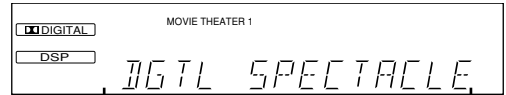
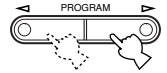

DSP program name



- If desired, adjust the delay time and the sound output level of each speaker. (Refer to “DELAY TIME AND SPEAKER OUTPUT LEVELS” on page 37 for details.)

Notes

- Choose a DSP program based on your listening preference, and not on the name of the program. The acoustics of your listening room affect the DSP program. Minimize the sound reflections in your room to maximize the effect created by the program.
- When you select an input source, this unit automatically selects the last DSP program used with that source.
- When you set this unit in the standby mode, the current source and DSP program are memorized and are automatically selected when you turn on the power again.
- If a Dolby Digital or DTS signal is input when the input mode is set to AUTO, the DSP program automatically switches to the appropriate decoding program.
- When a monaural source is being played with PRO LOGIC/ NORMAL or PRO LOGIC/ENHANCED, no sound will be heard from the main speakers and the rear speakers. Sound can only be heard from the center speaker. However, if “CENTER SP” in the SET MENU is set to NON, the center channel sound is output from the main speakers.
- When a source connected to the 6CH INPUT jack of this unit is selected, the digital sound field processor cannot be used.

• HTR-5450 only

When 96-kHz sampling digital signals are input to this unit, the DSP program cannot be selected. In this case, the sound is reproduced as normal 2-channel stereo.

■ Virtual CINEMA DSP and SILENT CINEMA

Virtual CINEMA DSP

Virtual CINEMA DSP allows you to enjoy the sound field effects of the DSP program without rear speakers. Using YAMAHA original technology, natural surround reproduction is possible through the generation of a virtual speaker.

The sound field processing is changed to the Virtual CINEMA DSP mode by setting “REAR LR SP” on the SET MENU to NON. Virtual CINEMA DSP is performed by using the main speakers.

Note

- This unit is not set in the Virtual CINEMA DSP mode even if “REAR LR SP” is set to NON in the following cases:
 - when the 5CH STEREO, PRO LOGIC/NORMAL, DOLBY DIGITAL/NORMAL or DTS/NORMAL program is selected;
 - when the sound effect is turned off;
 - when 6CH INPUT is selected as the input source;
 - when the Dolby Digital KARAOKE source is played;
 - when using the test tone;
 - when connecting the headphones (you will hear SILENT CINEMA); or
 - **HTR-5450 only**
 - when 96-kHz sampling digital signals are input to this unit.

SILENT CINEMA

SILENT CINEMA allows you to enjoy the realistic feel of the DSP program while using headphones. This feature delivers powerful surround reproduction just as if listening through the speakers.

You can listen to SILENT CINEMA by connecting your headphones to the PHONES jack while the effect speakers are on.

Canceling the Sound Effect (turning off the effect speakers)

Press EFFECT to cancel the sound effect and monitor only the main sound.

Press EFFECT again to turn the sound effect back on.

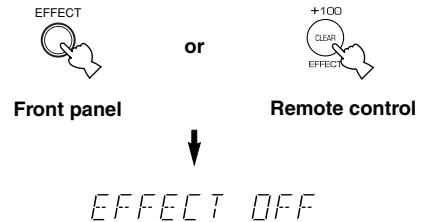

Notes

- If the sound effect is canceled when Dolby Digital or DTS is decoding, the sounds of the center and rear channels are mixed and output from the main speakers.
- If you turn off the sound effect when Dolby Digital or DTS is decoding, it may happen that the sound is output faintly or not output normally, depending on the source. In that case, turn back on the sound effect.

Connecting the Antennas

Both AM and FM indoor antennas are included with this unit. In general, these antennas should provide sufficient signal strength.

Connect each antenna correctly to the designated terminals.

FREQUENCY STEP switch (China and General models only)

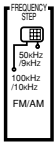

Because the interstation frequency spacing differs in different areas, set the FREQUENCY STEP switch (located at the rear) according to the frequency spacing in your area.
 North, Central and South America: 100 kHz/10 kHz
 Other area: 50 kHz/9 kHz
 Before setting this switch, disconnect the AC power plug of this unit from the AC outlet.

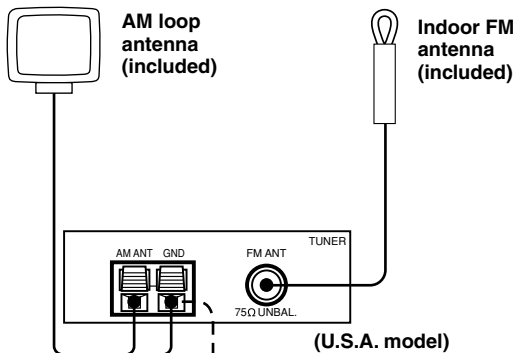

AM loop antenna (included)

Indoor FM antenna (included)

(U.S.A. model)

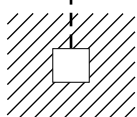

Ground (GND terminal)
 For maximum safety and minimum interference, connect the antenna GND terminal to a good earth ground. A good earth ground is a metal stake driven into moist earth.

Connecting the indoor FM antenna

Connect the included indoor FM antenna to the FM ANT 75Ω UNBAL. terminal.

Note

- Do not connect an outdoor FM antenna and the indoor FM antenna at the same time.

Connecting the AM loop antenna

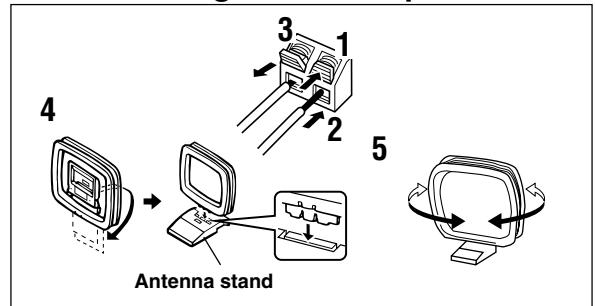

- Press and hold the tab to unlock the terminal hole.
- Insert the AM loop antenna lead wires into the AM ANT and GND terminals.
- Release the tab to lock the lead wires. Lightly pull the lead wires to confirm a good connection.
- Attach the loop antenna to the antenna stand.
- Orient the AM loop antenna so that the best reception is obtained.



- The AM loop antenna can be removed from the stand and attached to a wall, etc.

Notes

- The AM loop antenna should be placed away from this unit.
- The AM loop antenna should always be connected, even if an outdoor AM antenna is connected to this unit.

A properly installed outdoor antenna provides clearer reception than an indoor one. If you experience poor reception quality, an outdoor antenna may improve the quality. Consult the nearest authorized YAMAHA dealer or service center about the outdoor antennas.

Automatic Tuning

Automatic tuning is effective when station signals are strong and there is no interference.

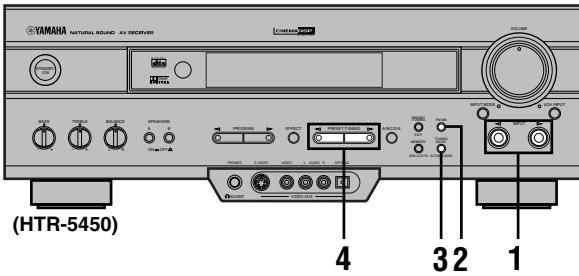

1 Use INPUT ◀/▶ to select TUNER as the input source.

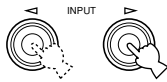

2 Press FM/AM to select the reception band (FM or AM).
“FM” or “AM” appears on the display.

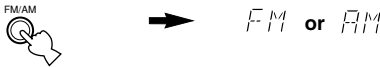

3 Press TUNING MODE (AUTO/MAN'L MONO) so that the “AUTO” indicator lights up on the display.

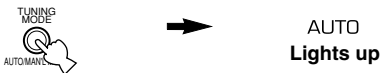

If “>” appears on the display next to the band indication, press PRESET/TUNING (EDIT) to turn it off.

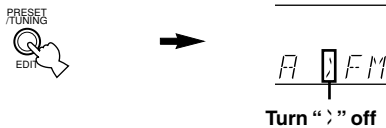

4 Press PRESET/TUNING ◀ once to tune in to a lower frequency and ▶ once to tune in to a higher frequency.

Press the button again if the tuning search does not stop at the desired station.



- Use the manual tuning method if the tuning search does not stop at the desired station (because the signal from the station is weak).
- When tuned in to a station, the “TUNED” indicator lights up and the frequency of the received station is shown on the display.

Manual Tuning

If the signal from the station you want to select is weak, you must tune in to it manually.

1 Use INPUT ◀/▶ to select TUNER as input source.

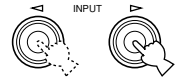

2 Press FM/AM to select the reception band (FM or AM).

“FM” or “AM” appears on the display.

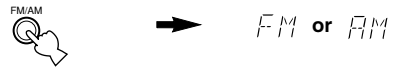

3 Press TUNING MODE (AUTO/MAN'L MONO) so that the “AUTO” indicator goes off.



If “>” appears on the display next to the band indication, press PRESET/TUNING (EDIT) to turn it off.

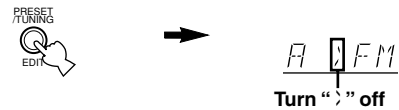

4 Press PRESET/TUNING ◀ or ▶ to tune in to the desired station.

To continue the tuning search, hold down the button.

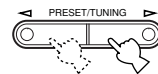

Note

- If you tune in manually to an FM station, it will be automatically received in monaural mode to increase the signal quality.

Automatic Preset Tuning (for FM stations only)

You can make use of the automatic preset tuning function for FM stations only. This function enables the unit to automatically tune in with strong signals and to sequentially store up to 40 FM stations (5 groups x 8 stations).

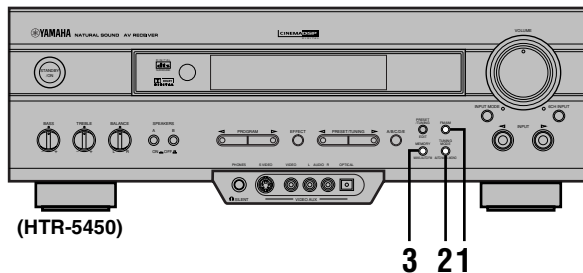

1 Press FM/AM to select the FM band.

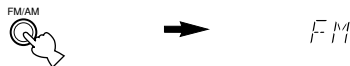

2 Press TUNING MODE (AUTO/MAN'L MONO) so that the "AUTO" indicator lights up on the display.



3 Hold down MEMORY (MAN'L/AUTO FM) for about 3 seconds.

The preset number, the "MEMORY" and "AUTO" indicators flash. After about 5 seconds, automatic preset tuning begins from the frequency currently displayed toward the higher frequencies. Received stations are sequentially stored as A1, A2 ... A8. If more than 8 stations have been tuned, they are stored as preset station numbers in other groups (B, C, D and E) in that order.

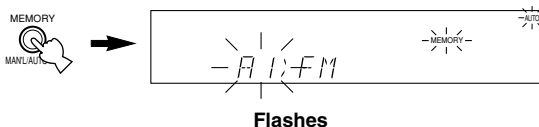

Automatic preset tuning options

You can select the preset number from which the unit will store FM stations and/or begin tuning toward lower frequencies. Before automatic preset tuning begins (after pressing MEMORY in step 3),

1. Press A/B/C/D/E and PRESET/TUNING ◀ or ▶ to select the preset number with which the first station will be stored. The automatic preset tuning will stop when stations have all been stored up to E8.
2. Press PRESET/TUNING (EDIT) to turn "◁" off and then press PRESET/TUNING ◀ to begin tuning toward lower frequencies.

When automatic preset tuning is completed

The display shows the frequency of the last preset station. Check the contents and the number of preset stations by following the procedure in the section "To Recall a Preset Station" on page 29.

Notes

- A new setting can be stored in place of the former one.
- The reception mode is stored along with the station frequency.
- You can manually replace a preset station with another FM or AM station by simply using the manual preset tuning method.
- Even if the number of received stations is not enough to be stored up to E8, automatic preset tuning is automatically ended after searching for all stations.
- Only FM stations with sufficient signal strength are stored by automatic preset tuning. If the station you want to store is weak in signal strength, tune in to it manually in monaural mode and store it by using the manual preset tuning method.

Memory back-up

The memory back-up circuit prevents the stored data from being lost when this unit is set in the standby mode. If, however, the power cord is disconnected from the AC power outlet or the power is cut for more than one week, the memory will be erased. If so, store the stations again by using preset tuning methods.

Manual Preset Tuning

You can also store up to 40 stations (5 groups x 8 stations) manually.

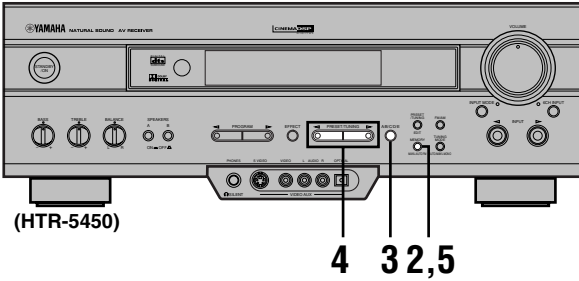

- 1 Tune in to the desired station.**
Refer to “Automatic/Manual Tuning” for the tuning procedure.
- 2 Press MEMORY (MAN'L/AUTO FM).**
The “MEMORY” indicator flashes for about 5 seconds.

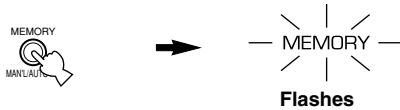

- 3 Press A/B/C/D/E repeatedly to select the desired group (A to E) of preset stations before the “MEMORY” indicator goes off.**
Make sure that “>” appears on the display. The selected group appears on the display.



- 4 Press PRESET/TUNING < or > to select a preset station number (1 to 8) with which you want to store the station before the “MEMORY” indicator goes off.**
Press < to select a lower preset station number and > to select a higher preset station number.

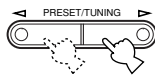

- 5 Press MEMORY (MAN'L/AUTO FM) before the “MEMORY” indicator goes off.**
The displayed station has been stored as the preset group and number you have selected, and the reception band and frequency appear and the “TUNED” indicator lights up on the display.

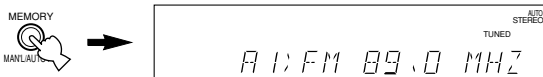

- 6 Repeat steps 1 to 5 to store other stations.**

Notes

- A new setting can be stored in place of the former one.
- The reception mode is stored along with the station frequency.

To Recall a Preset Station

You can recall any desired station simply by selecting the preset station number with which it was stored.

You can also recall a preset station with the remote control. Press AMP(TUNER) on the component selector and press TUNER on the input selector.

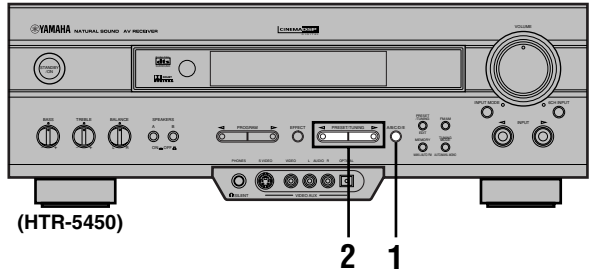

- 1 Press A/B/C/D/E to select the required group of preset stations.**

Make sure that “>” appears on the display.

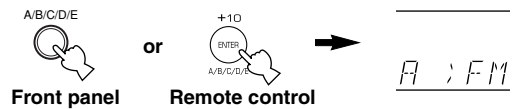

- 2 Press PRESET/TUNING < or > (or PRESET -/+) to select a preset station number (1 to 8).**

The preset group and number appear on the display along with the reception band, frequency, and the “TUNED” indicator lights up.

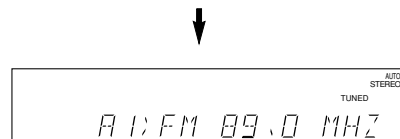
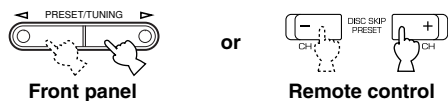

Exchanging Preset Stations

You can exchange the assignment of two preset stations with each other.

Example: Exchange preset station “E1” with “A5”

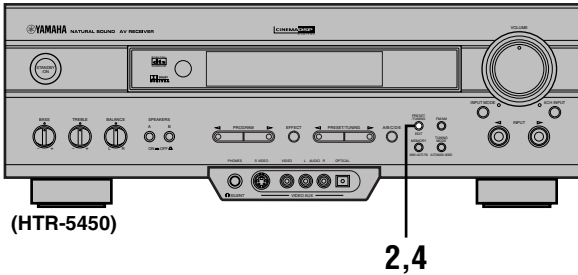

1 Recall preset station “E1”.

Refer to the procedure in the section “To Recall a Preset Station” on page 29.

2 Hold down (PRESET/TUNING) EDIT for about 3 second.

“E1” and the “MEMORY” indicator flash.

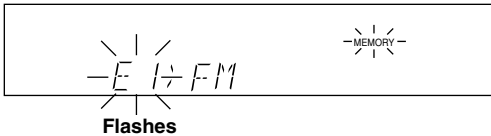

3 Recall preset station “A5” by using the buttons on the front panel.

“A5” and the “MEMORY” indicator flash.

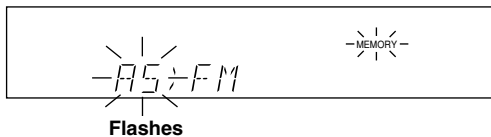

4 Press (PRESET/TUNING) EDIT again.

The display shows the exchange of stations has been completed.

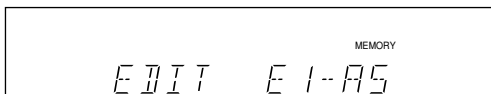

RECORDING A SOURCE

Recording adjustments and other operations are performed from the recording component. Refer to the instructions for these components.

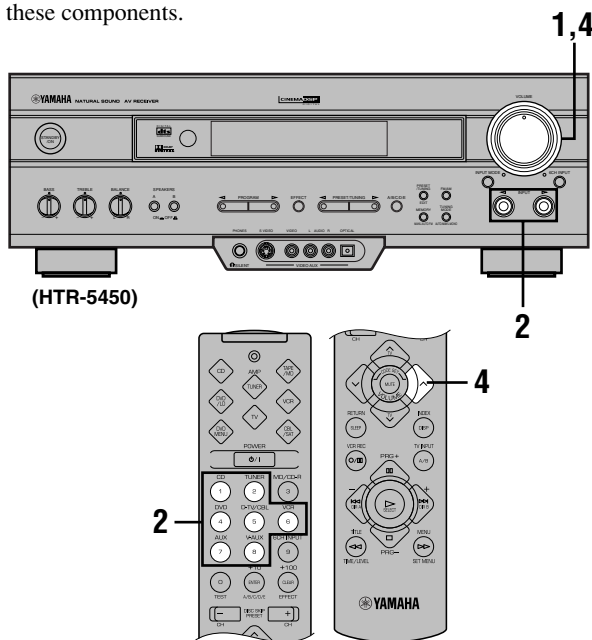

Notes

- Do a test recording before you start an actual recording.
- When this unit is set in the standby mode, you cannot record between other components connected to this unit.
- The DSP program and the setting of VOLUME, BASS, TREBLE and BALANCE have no effect on the material being recorded.
- A source connected to the 6CH INPUT jacks of this unit cannot be recorded.
- A given input source is not output on the same REC OUT channel. (For example, the signal input from VCR 1 IN is not output on VCR 1 OUT.)
- Check the copyright laws in your country to record from records, CDs, radio, etc. Recording of copyrighted material may infringe copyright laws.
- **HTR-5450 only**
Composite video and S video signals pass independently through this unit's video circuits. Therefore, when recording or dubbing video signals, if your video source component is connected to provide only an S video (or only a composite video) signal, you can record only an S video (or only a composite video) signal by your VCR.

If you play back a video source that uses scrambled or encoded signals to prevent it from being dubbed, the picture itself may be disturbed due to those signals.

Special considerations when recording DTS software HTR-5450 only

The DTS signal is a digital bitstream. Attempting to digitally record the DTS bitstream will result in noise being recorded. Therefore, if you want to use this unit to record sources that have DTS signals recorded on them, the following considerations and adjustments need to be made.

For DVDs and CDs encoded with DTS

Only 2-channel analog audio signals may be recorded. Set the DVD player (or CD player) as described in the player's operation instructions so that the audio signals are output from the player's analog outputs.

1 Set the volume at the minimum level.

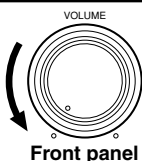

2 Select the source you want to record.

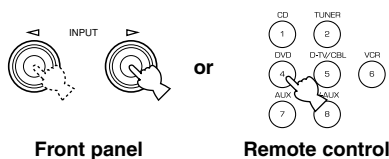

3 Begin recording by the recording component connected to this unit.

4 Play the source and then turn up the volume to confirm the input source.

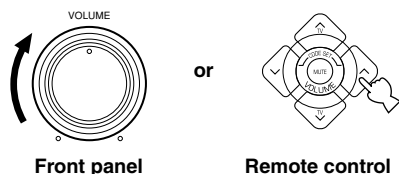



SET MENU

The SET MENU consists of 9 items including the speaker mode setting. Use the SET MENU to enjoy the optimum audio/video playback for your system.



- You can adjust the items on the SET MENU while playing a source.

1 SPEAKER SET

- CENTER SP
- MAIN SP
- REAR LR SP
- BASS OUT
- MAIN LVL

2 HP TONE CTRL

3 I/O ASSIGN

4 INPUT MODE

5 DOLBY D. SET

- LFE LEVEL
- D-RANGE

6 DTS SET

7 SP DLY TIME

8 DISPLAY SET

9 MEM. GUARD

Adjusting the Items on the SET MENU

Adjustment should be made with the remote control.

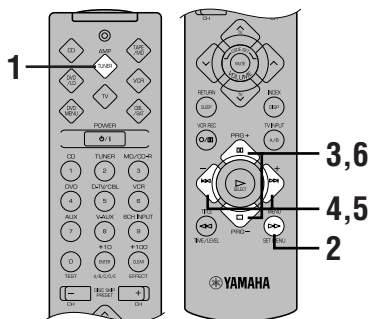

Note

- Some items require extra steps to change to the desired setting.

1 Press AMP(TUNER) on the component selector.



2 Press SET MENU to enter the SET MENU.



1 SPEAKER SET

3 Press PRG- (or PRG+) repeatedly to select the item (1 to 9) you want to adjust.

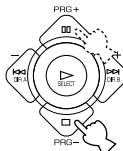

3 I/O ASSIGN



- By pressing SET MENU repeatedly, you can select items in the same order as when pressing PRG-.

4 Press - or + once to enter the setup mode of the selected item.

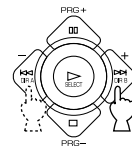

3A(1) MD/CD-R

Depending on the item, press PRG- (or PRG+) to select a sub item.

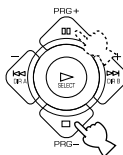

3B(2) MD/CD-R

5 Press - or + repeatedly to change the setting of the item.

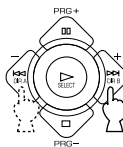

3B(2) CD

6 Press PRG- (or PRG+) repeatedly until the input source name appears to exit from the SET MENU.

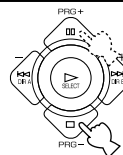

Memory back-up

The memory back-up circuit prevents the stored data from being lost even if this unit is set in the standby mode, the power cord is disconnected from the AC outlet, or the power supply is temporarily cut due to power failure. However, if the power is cut for more than one week, the settings of the SET MENU you adjusted will return to the factory settings. If so, adjust the items again.

1 SPEAKER SET (speaker mode settings)

Use this feature to select suitable output modes for your speaker configuration.

Notes

- When 6CH INPUT is selected as the input source, level adjustments in items of "1 SPEAKER SET" are not affected (except "MAIN LVL").
- **HTR-5450 only**
When 96-kHz sampling digital signals are input to this unit, level adjustments in items "MAIN SP", "BASS OUT" and "MAIN LVL" are possible, but those in items "CENTER SP" and "REAR LR SP" are not affected.

■ CENTER SP (center speaker mode)

By adding a center speaker to your speaker configuration, the unit can provide good dialog localization for many listeners and superior synchronization of sound and images.

Choices: LRG (large), SML (small), NON (none)

Initial setting: LRG

CENTER SP:LRG

LRG

Select this if you have a large center speaker. The entire range of the center channel signal is directed to the center speaker.

SML

Select this if you have a small center speaker. The low-frequency signals (90 Hz and below) of the center channel are directed to the speakers selected with "BASS OUT".

NON

Select this if you do not have a center speaker. All of the center channel signals are directed to the left and right main speakers.

■ MAIN SP (main speaker mode)

Choices: LARGE, SMALL

Initial setting: LARGE

MAIN SP:LARGE

LARGE

Select this if you have large main speakers. The entire range of the left and right main channel signal is directed to the left and right main speakers.

SMALL

Select this if you have small main speakers. The low-frequency signals (90 Hz and below) of the main channel are directed to the speakers selected with "BASS OUT".

Note

- When you select MAIN for "BASS OUT", the low-frequency signals (90 Hz and below) of the main channel are directed to the main speakers even if you select SMALL for the main speaker mode.

■ REAR LR SP (rear speaker mode)

Choices: LRG (large), SML (small), NON (none)

Initial setting: LRG

REAR LR SP:LRG

LRG

Select this if you have large left and right rear speakers or if a rear subwoofer is connected to the rear speakers. The entire range of the rear channel signal is directed to the left and right rear speakers.

SML

Select this if you have small left and right rear speakers. The low-frequency signals (90 Hz and below) of the rear channel are directed to the speakers selected with "BASS OUT".

NON

Select this if you do not have rear speakers.



- This unit is set in the Virtual CINEMA DSP mode by selecting NON for "REAR LR SP".

■ BASS OUT (bass out mode)

LFE signals carry low-frequency effects when this unit decodes a Dolby Digital or DTS signal. Low-frequency signals are defined as 90 Hz and below.

Choices: SWFR (subwoofer), MAIN, BOTH

Initial setting: BOTH



SWFR

Select this if you use a subwoofer. The LFE signals are directed to the subwoofer.

MAIN

Select this if you do not use a subwoofer. The LFE signals are directed to the main speakers.

BOTH

Select this if you use a subwoofer and you want to mix the main channel low-frequency signals with the LFE signals.

Notes

- When playing a 2-channel source (CD, MD, tape, video cassette etc.), select BOTH position to direct low bass signals (below 90 Hz) to the SUBWOOFER jack.
- When you select SMALL (SML) for items "CENTER SP", "MAIN SP" and "REAR LR SP", the low-frequency signals (90 Hz and below) from those channels are added to the LFE and output to the subwoofer.

■ MAIN LVL (main level mode)

Change this setting if you cannot match the output level of the center and rear speakers with the main speakers because of the unusually high-efficiency performance of the main speakers.

Choices: NORM (normal), -10 dB

Initial setting: NORM

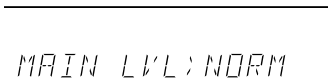

NORM (normal)

Normally select this setting.

-10 dB

Select this if you cannot match the output level of your effect speakers with that of your main speakers when using the test tone. This setting decreases the main speaker output level to about one-third of the normal level.

2 HP TONE CTRL (headphone tone control)

Use this feature to adjust the level of the bass and treble when you use your headphones.

Control range (dB): -6 to +3

Initial setting: 0 dB for both BASS and TRBL (treble)



3 I/O ASSIGN

It is possible to assign jacks according to the component to be used if this unit's DIGITAL jack settings (component names for terminals) differ from that component. This makes it possible to change the jack assignment and effectively connect more component.

Once you assign, you can select that component with INPUT </> (or the input selector buttons).

HTR-5450

■ 3A (1) (for the OPTICAL OUTPUT jack)

Initial setting: (1) MD/CD-R

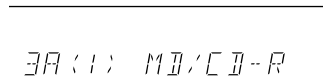

■ 3B (2) to (4) (for the OPTICAL INPUT jacks)

Initial settings: (2) MD/CD-R

(3) DVD

(4) D-TV/CBL

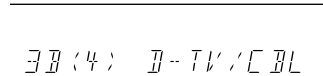
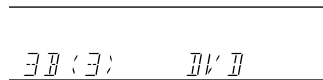
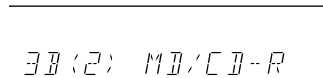

■ 3C (5) (for the COAXIAL INPUT jack)

Initial setting: (5) CD

3C (5) CD

Note

- You cannot select an item more than once for the same type of jack.

HTR-5440

■ 3A (1) and (2) (for the OPTICAL INPUT jacks)

Initial settings: (1) DVD
(2) D-TV/CBL

3A (1) DVD

3A (2) D-TV/CBL

■ 3B (3) (for the COAXIAL INPUT jack)

Initial setting: (3) CD

3B (3) CD

Note

- You cannot select an item more than once for the same type of jack.

4 INPUT MODE (initial input mode)

Use this feature to designate the input mode when turning on the power of this unit with the source component connected to more than one type of input jacks.

Choices: AUTO, LAST

Initial setting: AUTO

:AUTO LAST

AUTO

Select this to allow this unit to automatically detect the type of input signal and select the appropriate input mode.

LAST

Select this to set this unit to automatically select the last input mode used for that source.

5 DOLBY D. SET (Dolby Digital set)

This setting is effective only when this unit decodes Dolby Digital signals.

■ LFE LEVEL

Use this feature to adjust the output level of the LFE (low-frequency effect) channel when playing back a Dolby Digital signal. The LFE signal carries the low-frequency special effect sound which is only added to certain scenes.

Control value (dB): -20 to 0

Initial setting: 0 dB

LFE LEVEL 0dB

Notes

- Adjust the LFE level according to the capacity of your subwoofer.
- Normally, around -6 dB to -8 dB is most suitable for listening at home.

HTR-5440

■ D-RANGE (dynamic range)

Use this feature to adjust the dynamic range (the difference between the maximum level and the minimum level of sounds).

Choices: MAX, STD (standard), MIN

Initial setting: MAX

D-RANGE: MAX

- Select MAX for feature films.
- Select STD for general use.
- Select MIN for listening to sources at an extremely low volume level.

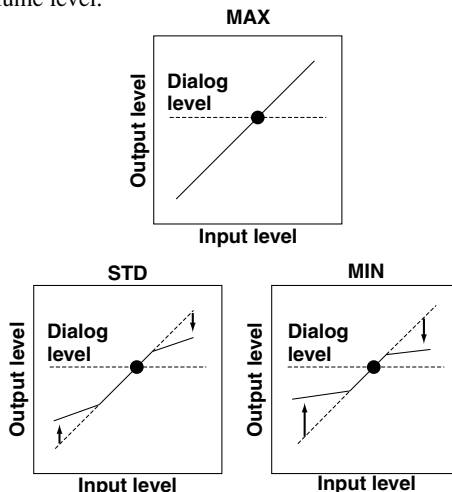

Note

- When you select MIN, the sound output may be faint because some Dolby Digital signals are not compatible with the minimum-level dynamic range. In this case, select MAX or STD.

6 DTS SET (DTS LFE level)

This setting is effective only when this unit decodes DTS signals.

Use this feature to adjust the output level of the LFE (low-frequency effect) channel when playing back a DTS signal. The LFE signal carries the low-frequency special effect sound which is only added to certain scenes.

Control range (dB): -10 to +10
Initial setting: 0 dB



Note

- Adjust the LFE level according to the capacity of your subwoofer.

7 SP DLY TIME (center delay)

Use this feature to adjust the delay of the center channel sound. This feature works when this unit decodes a Dolby Digital or DTS signal. Ideally, the center speaker should be the same distance from the listening position as the left and right main speakers. However, in most home situations, the center speaker is placed in line with the main speakers. By delaying the sound from the center speaker, the apparent distance from the center speaker to the listening position can be adjusted to make it seem the same as the distance between the left and right main speakers to the listening position. Adjusting the delay time for the center speaker is especially important for giving depth to the dialog.

Control range (ms): 0 to 5
Initial setting: 0 ms

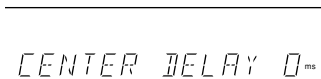

Center speaker image

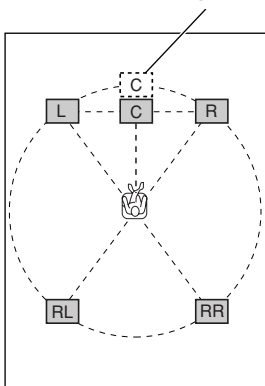

- Increasing the delay by 1 ms simulates moving the speaker about 30 cm (one foot) farther away from the actual position of the center speaker.

8 DISPLAY SET

■ DIMMER

You can adjust the brightness of the display.

Control range : -4 to 0
Initial setting: 0



9 MEM. GUARD (memory guard)

Use this feature to prevent accidental changes to the setting of the SET MENU and other settings on this unit.

Choices: ON, OFF
Initial setting: OFF



Select ON to protect the following features:

- All SET MENU items
- Center, rear speakers and subwoofer levels
- Delay time adjusted by using TIME/LEVEL

Notes

- When “9 MEM. GUARD” is set to ON, you cannot use the test tone.
- When “9 MEM. GUARD” is set to ON, you cannot select any other SET MENU items.



DELAY TIME AND SPEAKER OUTPUT LEVELS

When using the digital sound field processor with the Dolby Pro Logic decoder, Dolby Digital decoder or DTS decoder, you can adjust the delay time between the main sound and sound effect, and each speaker's output level as you wish.

Delay Time

You can adjust the time difference between the beginning of the sound from the main speakers and the beginning of the sound effect from the rear speakers. The larger the value, the later the sound effect is generated. The delay time can be individually adjusted to all DSP programs.

Notes

- Adding too much delay will cause an unnatural effect with some sources.
- The sound is momentarily interrupted while adjusting the delay time.

	Program	Preset value (ms)
1.	CONCERT HALL	45
2.	JAZZ CLUB	30
3.	ROCK CONCERT	15
4.	DISCO	26
	5CH STEREO	2
	GAME	36
5.	TV SPORTS	10
6.	MONO MOVIE	69
7.	70 mm SPECTACLE	23
	DGTL SPECTACLE	13
	DTS SPECTACLE	13
	70 mm SCI-FI	20
	DGTL SCI-FI	16
	DTS SCI-FI	16
8.	70 mm ADVENTURE	20
	DGTL ADVENTURE	15
	DTS ADVENTURE	15
	70 mm GENERAL	20
	DGTL GENERAL	15
9.	DTS GENERAL	15
	PRO LOGIC/NORMAL	20
	DOLBY DIGITAL/NORMAL	5
	DTS DIGITAL SUR./NORMAL	5
	PRO LOGIC/ENHANCED	20
DOLBY DIGITAL/ENHANCED	5	
	DTS DIGITAL SUR./ENHANCED	5

Sound Output Level of the Center, Right Rear and Left Rear Speakers, and Subwoofer

If desired, you can adjust the sound output level of each speaker even if it has already been adjusted in "ADJUSTING THE SPEAKER BALANCE" procedure.

Notes

- If "CENTER SP" in the SET MENU is set to the NON position, the sound output level of the center speaker cannot be adjusted. This is because the center channel sound is automatically output from the right and left main speakers.
- Once the sound output level has been adjusted, the level will be the same for all DSP programs.

Speaker	Preset value (dB)
Center	0
Right rear	0
Left rear	0
Subwoofer	0

Adjusting Method

Adjustments should be performed with the remote control while watching the information on the display.

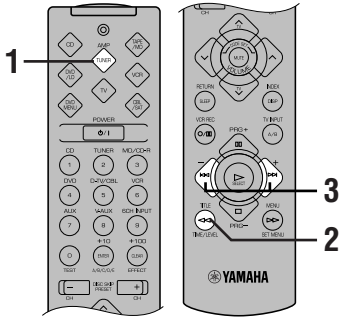

1 Press AMP(TUNER) on the component selector.



2 Press TIME/LEVEL repeatedly to select the item you want to adjust.

Each time you press TIME/LEVEL, the selected item changes and appears on the display as below.

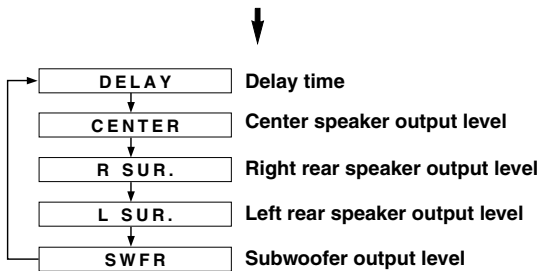

Note

- Depending on the setting of the SET MENU, you may not be able to select all these items.

3 Press – or + to adjust the delay time or speaker output levels.

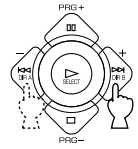

4 Repeat steps 2 and 3 to adjust the settings of any other item.

Notes

- If “CENTER SP” or “REAR LR SP” is set to NON, or “BASS OUT” is set to MAIN, the output level of that speaker cannot be adjusted.
- When you adjust the output level with TIME/LEVEL, the settings you made with the test tone will be changed.
- To adjust speakers other than the subwoofer, the adjusting procedure using test tones on page 19 is recommended.

Memory back-up

The memory back-up circuit prevents the stored data from being lost when this unit is set in the standby mode. If, however, the power cord is disconnected from the AC power outlet or the power is cut for more than one week, the latest values for the delay time and the center/rear/subwoofer output levels that were set will automatically return to the preset values. If so, adjust the delay time and output levels again.



SLEEP TIMER

The SLEEP timer can be used to automatically set this unit in the standby mode. This timer is useful when you are going to sleep while enjoying a broadcast or other desired input source. The SLEEP timer can only be set with the remote control.

Notes

- First press AMP(TUNER), TAPE/MD, CD or DVD/LD on the component selector to set the SLEEP timer for this unit.
- The SLEEP timer is effective for the components connected to the AC OUTLET(S) on the rear panel of this unit.

Setting the SLEEP Timer

1 Play a source you want to enjoy when you are going to sleep.

2 Press SLEEP repeatedly to select the desired SLEEP time.



Each time you press SLEEP, the SLEEP time will change as below:

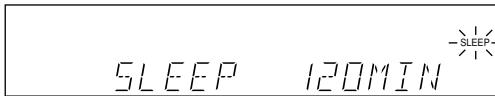
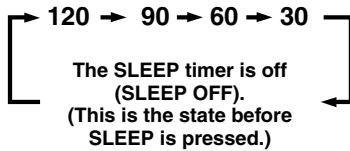

Flashes

3 The “SLEEP” indicator soon lights up on the display after the SLEEP timer has been set.

The display returns to the previous indication.

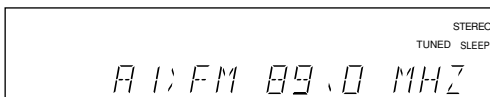

Lights up

Canceling the SLEEP Timer

Press SLEEP repeatedly until “SLEEP OFF” appears on the display.

It will soon disappear and the “SLEEP” indicator will go off.

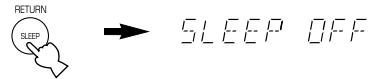

Note

- The SLEEP timer can also be canceled by setting the unit in the standby mode by using POWER on the remote control (or STANDBY/ON), or by disconnecting the AC power cord from the AC power outlet.



PRESET REMOTE CONTROL

It is possible to control this unit and other YAMAHA A/V components using the remote control supplied with this unit. It is also possible to control components from other manufacturers (or some YAMAHA components) by setting the proper manufacturer code (a signal assigned to each manufacturer and component).

Note

- For the notes on batteries, operating distance and names and functions of the remote control, refer to each description in this manual.

Component Selector Buttons

There are eight component selector buttons. Press one of these buttons which corresponds to the component you want to control with the remote control. For example, if you press CD on the component selector, the remote control is set to the CD operation mode, allowing the CD player to be controlled.

AMP(TUNER)

You can perform the basic operations of this unit.

CD

The code for a YAMAHA CD player is factory set.

DVD/LD & DVD MENU

An LD player can be controlled in the DVD/LD mode. A DVD player can be controlled in the DVD/LD and DVD MENU modes. The code for a YAMAHA DVD player is factory set.

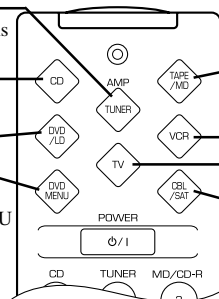

TAPE/MD

The code for a YAMAHA MD deck is factory set. (The code for the YAMAHA CD recorder and tape deck can also be set.)

VCR

A VCR can be controlled.

TV

A TV can be controlled.

CBL/SAT

A cable TV or satellite tuner can be controlled.

Notes

- The button functions on the remote control differ depending on the operation mode. Refer to the following pages for details.
- When shipped from the factory, the YAMAHA manufacturer codes listed on page 49 are set for each dial position. If unable to operate your YAMAHA A/V component, please try using another YAMAHA code.

Controlling the Components Connected to This Unit

Example: To control YAMAHA CD player

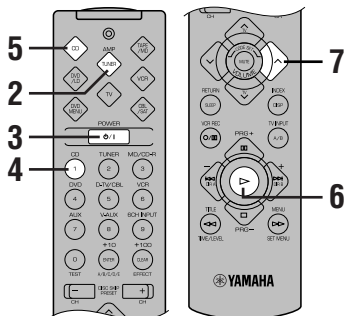

1 Make sure that the volume is set at the minimum level.

2 Press AMP(TUNER) on the component selector.



3 Turn on the power.



4 Press CD on the input selector.



5 Press CD on the component selector.



6 Press .

Refer to “Description of Each Mode” for the CD player operation buttons.

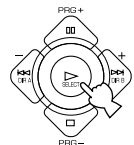

7 Adjust the volume.

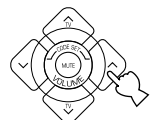

If you set the remote control with the manufacturer codes listed from page i at the end of this manual, you can control other brands of components. Refer to “Setting the Manufacturer Code” for details.

Description of Each Mode

■ TAPE/MD MODE

Note

- TV VOLUME functions if you have set the code for your TV.

POWER
This button turns this unit on if you have set the code for a YAMAHA tape deck, MD recorder or CD recorder. This button turns on the tape deck, MD recorder or CD recorder that has a remote control with a power button if you have set the code.

Press TAPE/MD.

Input selector buttons

6CH INPUT

EFFECT

VOLUME

MUTE

TV VOLUME

SLEEP

DISC SKIP PRESET

DISPLAY (MD/CD-R)

DECK A/B (TAPE)
This button selects deck A or B on a double-cassette tape deck.

PAUSE (MD/CD-R)
This button gives a pause in operation.

DIR B (TAPE)
This button selects the playing direction of deck B.

SKIP+ (MD/CD-R)
This button skips to the next track.

STOP
This button stops operation on a tape deck, MD recorder or CD recorder.

FAST FORWARD (TAPE)
This button winds a tape fast forward.

SEARCH (MD/CD-R)
This button initiates a fast-forward search on the track that is playing to find the point from which you want to listen.

REC/PAUSE
This button gives a pause in recording on a tape deck or MD recorder.

PLAY
This button plays a tape, an MD or CD-R.

DIR A (TAPE)
This button selects the playing direction of deck A.

SKIP- (MD/CD-R)
This button skips to the previous track.

REWIND (TAPE)
This button rewinds a tape.

SEARCH (MD/CD-R)
This button initiates a backward search on the track that is playing to find the point from which you want to listen.

ADVANCED OPERATION

- The dark-shaded buttons do not function even if you have set up the manufacturer code.
- Some of them may not function depending on the component you have. In this case, use the original remote control supplied with your component.

English

CD MODE

Note

- TV VOLUME and TV INPUT function if you have set the code for your TV.

Press CD.

POWER
This button turns this unit on if you have set the code for a YAMAHA CD player. This button turns on the CD player that has a remote control with a power button if you have set the code.

Input selector buttons

6CH INPUT

EFFECT

DISC SKIP +/- (for a CD player with CD changer)
These buttons skip to the next or previous CD.

TV VOLUME

DISPLAY

TV INPUT

PAUSE
This button gives a pause in operation. The button functions as PAUSE/STOP* for operating a YAMAHA CD player under factory setting.

SKIP+
This button skips to the beginning of the next track.

STOP
This button stops operation. The button functions as PAUSE/STOP* for operating YAMAHA CD players.

SEARCH
This button initiates a fast-forward search on the track that is playing to find the point from which you want to listen.

PLAY
This button plays a CD.

SKIP-
This button skips to the beginning of the previous track.

SEARCH
This button initiates a backward search on the track that is playing to find the point from which you want to listen.

VOLUME

MUTE

SLEEP

RETURN

VCR REC

O/00

PRG+

TV INPUT

A/B

SELECT

PRG-

MENU

SET MENU

YAMAHA

- The dark-shaded buttons do not function even if you have set up the manufacturer code.
- Some of them may not function depending on the component you have. In this case, use the original remote control supplied with your component.

DVD/LD MODE

Note

- TV VOLUME and TV INPUT function if you have set the code for your TV.

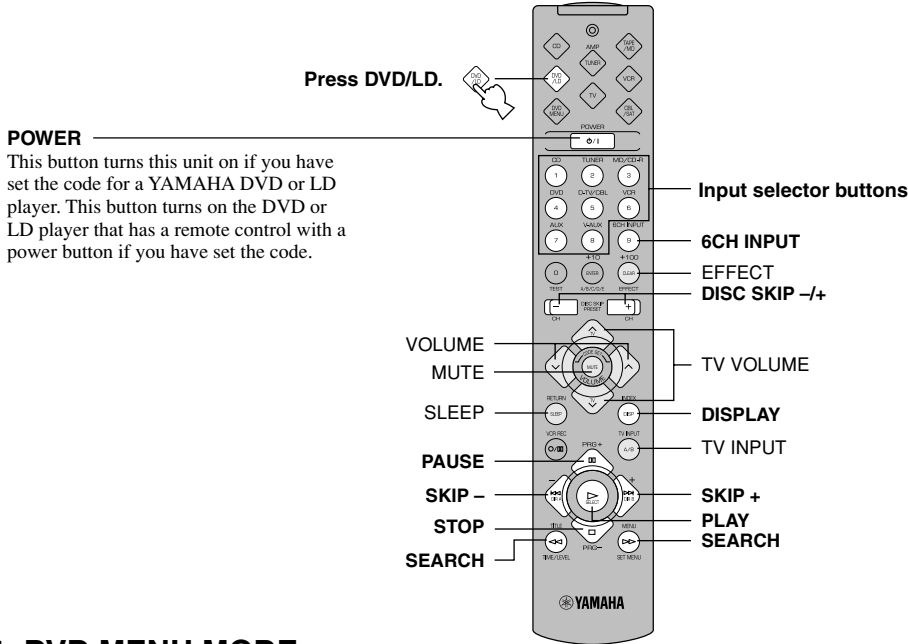

DVD MENU MODE

Notes

- TV VOLUME and TV INPUT function if you have set the code for your TV.
- DVD MENU operations cannot be performed for some DVD players.

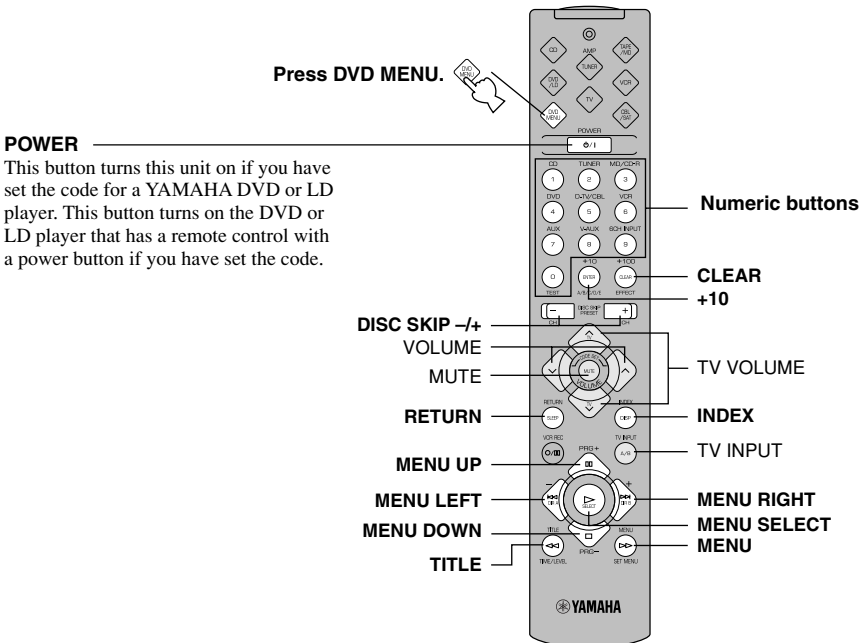

- The dark-shaded buttons do not function even if you have set up the manufacturer code.
- Some of them may not function depending on the component you have. In this case, use the original remote control supplied with your component.

VCR MODE

Note

- TV VOLUME, TV INPUT and TV SLEEP function if you have set the code for your TV.

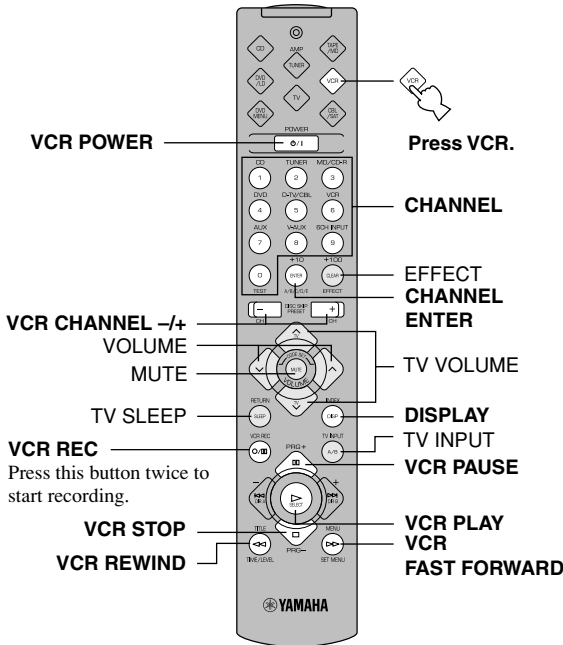

CBL/SAT MODE

Note

- TV VOLUME, TV INPUT and TV SLEEP function if you have set the code for your TV.

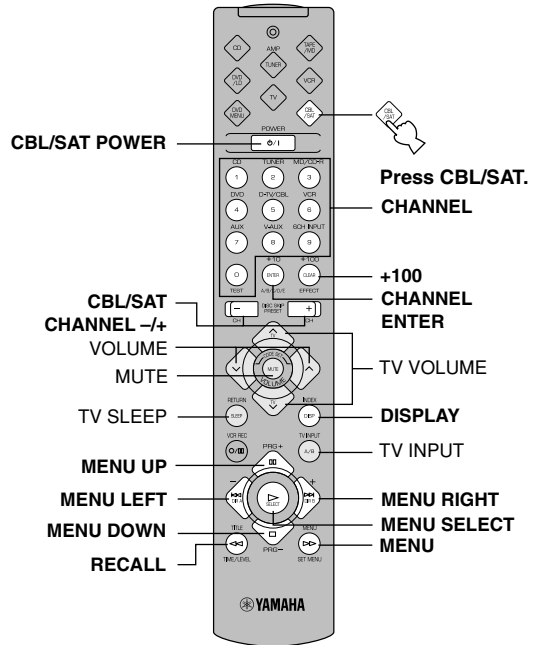

TV MODE

Note

- You can control your VCR if you have set the code for it.

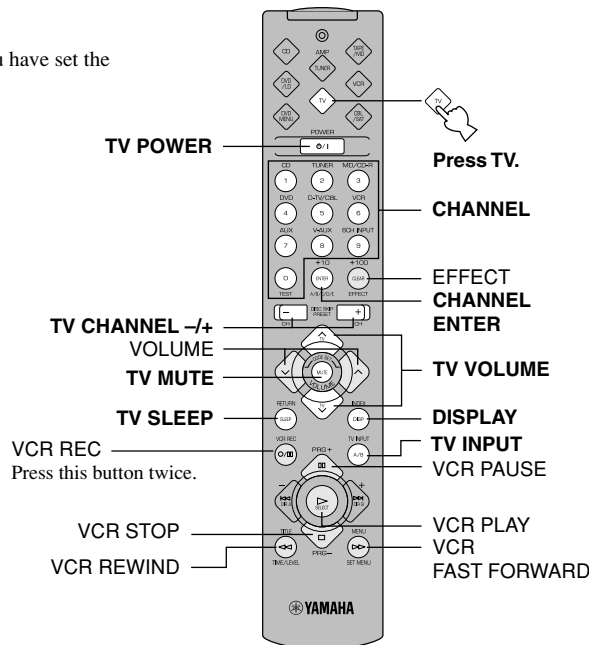

- The dark-shaded buttons do not function even if you have set up the manufacturer code.
- Some of them may not function depending on the component you have. In this case, use the original remote control supplied with your component.

Setting the Manufacturer Code

You can set the code for the manufacturer of your component after pressing the component selector buttons other than AMP(TUNER).

1 Turn on your component to be used.

2 Press one of the component selector buttons which corresponds to the component to be controlled.



3 Press both VOLUME buttons (▲▼) at the same time for about four seconds.

The indicator flashes twice.

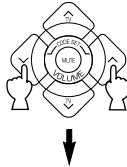

4 Use the numeric buttons to enter the four-digit manufacturer code for the component to be used. Make sure that the indicator flashes twice.

If the indicator does not flash, repeat step 3 and re-enter the code.

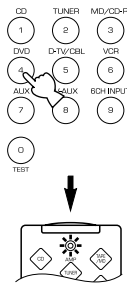

5 Press POWER (or any other button) on the remote control to check if you have set the code correctly.

If your component cannot be controlled with the remote control, try setting another code for the same manufacturer.



Notes

- You can set only one code for one mode.
- In the DVD/LD and DVD MENU modes: Be sure to press DVD/LD on the component selector before entering the code for the DVD/LD player. You cannot set the code for a DVD player after pressing DVD MENU on the component selector. The code set in the DVD/LD mode is also simultaneously set in the DVD MENU mode.
- If your component does not respond to any of the codes listed for the manufacturer, use the original remote control supplied with your component.

To use a second (and third) VCR

You can control a second (and third) VCR in the CBL/SAT and DVD MENU modes if a cable TV or satellite tuner, or DVD player is not being used.

Note

- In order to set a second (and third) VCR in the DVD MENU mode, it is necessary to first set up the code for an LD player in the DVD/LD mode.

1 Turn on the VCR to be used.

2 Press CBL/SAT or DVD MENU on the component selector.



3 Press both VOLUME buttons (▲▼) at the same time for about four seconds.

The indicator flashes twice.

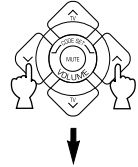

4 Use the numeric buttons to enter the four-digit code for the second (and third) VCR. Make sure that the indicator flashes twice.

If the indicator does not flash, repeat step 3 and re-enter the code.

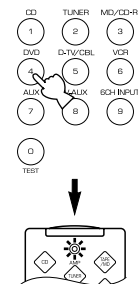

5 Press POWER (or any other button) on the remote control to check if you have set the code correctly.

If the VCR cannot be controlled with the remote control, try setting another code for the same manufacturer.



Returning to the Factory Setting

To return to the factory-set codes in all modes

- 1 Press one of the component selector buttons other than AMP(TUNER).



- 2 Press both VOLUME buttons (↕↕) at the same time for about four seconds.

The indicator flashes twice.

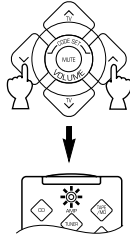

- 3 Enter the code number "9990".

Make sure that the indicator flashes twice.

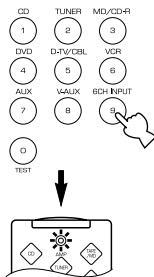

To return to the factory-set codes in each mode

- 1 Press one of the component selector buttons which corresponds to the component to be returned to the factory-set code.



- 2 Press both VOLUME buttons (↕↕) at the same time for about four seconds.

The indicator flashes twice.

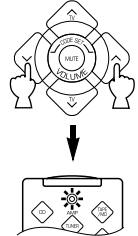

- 3 Enter the code number "0000".

Make sure that the indicator flashes twice.

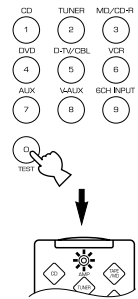

The following codes are factory set.

Component selector button	Component	Code	Set component	Set code
TV	TV	0101		
CBL/SAT	Cable TV	0006		
VCR	VCR	0002		
DVD/LD	DVD player	0008 (YAMAHA DVD player)		
CD	CD player	0005 (YAMAHA CD player)		
TAPE/MD	MD recorder	0024 (YAMAHA MD recorder)		

We recommend that you write all the code numbers you have set on the table above.



SOUND FIELD PROGRAM

A digital sound field processor (DSP) based on the latest YAMAHA technology is built into this unit. It is possible to play back various sound fields for the source you are listening to.

Note

- Regardless of the program name and characteristics listed in the table below, select the sound field program that sounds best to you.

Hi-Fi DSP Programs

■ For audio sources: Nos. 1 to 4

No.	Program (group)	Sub-program	Features
1	CONCERT HALL	—	A large round concert hall with a rich surround effect. Pronounced reflections from all directions emphasize the extension of sounds. The sound field has a great deal of presence, and your virtual seat is near the center, close to the stage.
2	JAZZ CLUB	—	This is the sound field at stage front in “The Bottom Line”, a famous New York jazz club. The floor can seat 300 people to the left and right in a sound field offering a real and vibrant sound.
3	ROCK CONCERT	—	The ideal program for lively, dynamic rock music. The data for this program was recorded at LA’s “hottest” rock club. The listener’s virtual seat is at the center-left of the hall.
4	ENTERTAINMENT	DISCO	This program recreates the acoustic environment of a lively disco in the heart of a big city. The sound is dense and highly concentrated. It is also characterized by a high-energy, “immediate” sound.
		5CH STEREO	Using this program increases the listening position range. This is a sound field suitable for background music at parties.

Note

- Reverberations (sound effects) for realizing the sound field and unprocessed stereo from the left and right main speakers is output. The sound is not output from the center speaker. (The sound is output when one of these programs is selected while playing a source encoded with a Dolby Digital or DTS signal. If 5CH STEREO is selected, the sound is output from all speakers regardless of the input source.)

CINEMA DSP Programs

■ For audio-video sources: Nos. 4 to 6

No.	Program (group)	Sub-program	Features
4	ENTERTAINMENT	GAME	This program adds a deep and spatial feeling to video game sounds.
5	TV SPORTS	—	Although the presence sound field is relatively narrow, the surround sound field employs the sound environment of a large concert hall. With this program, you can enjoy watching various TV programs such as news, variety shows, music programs or sports programs. In a stereo broadcast of a sports game, the commentator is oriented at the center position, and the shouts and the atmosphere in the stadium spread on the surround side, while their spread to the rear is properly restrained.
6	MONO MOVIE	—	This program is provided for reproducing monaural video sources (such as old movies). The program produces the optimum reverberation to create sound depth by using only the presence sound field.

■ For movie programs: Nos. 7 to 9

No.	Program (group)	Sub-program		Input source	Features	
7	MOVIE THEATER 1	SPECTACLE	70 mm SPECTACLE	Analog, PCM, Dolby Digital in 2-channel	This program creates the extremely wide sound field of a 70-mm movie theater. It precisely reproduces the source sound in detail, making both the video and the sound field incredibly real. This is ideal for any kind of video source encoded with Dolby Surround, Dolby Digital or DTS (especially large-scale movie productions).	
			DGTL SPECTACLE	Dolby Digital (5.1-channel)		
			DTS SPECTACLE	DTS		
		SCI-FI	70 mm SCI-FI	Analog, PCM, Dolby Digital in 2-channel		This program clearly reproduces dialog and sound effects in the latest sound form of science fiction films, thus creating a broad and expansive cinematic space amid the silence. You can enjoy science fiction films in a virtual-space sound field that includes Dolby Surround, Dolby Digital and DTS-encoded software employing the most advanced techniques.
			DGTL SCI-FI	Dolby Digital (5.1-channel)		
			DTS SCI-FI	DTS		
8	MOVIE THEATER 2	ADVENTURE	70 mm ADVENTURE	Analog, PCM, Dolby Digital in 2-channel	This program is ideal for precisely reproducing the sound design of the newest 70-mm and multichannel soundtrack films. The sound field is made to be similar to that of the newest movie theaters, so the reverberations of the sound field itself are restrained as much as possible.	
			DGTL ADVENTURE	Dolby Digital (5.1-channel)		
			DTS ADVENTURE	DTS		
		GENERAL	70 mm GENERAL	Analog, PCM, Dolby Digital in 2-channel		This program is for reproducing sounds from 70-mm and multichannel soundtrack films, and is characterized by a soft and extensive sound field. The presence sound field is relatively narrow. It spatially spreads all around and toward the screen, restraining the echo effect of conversations without losing clarity. For the surround sound field, the harmony of music or chorus sounds beautifully in a wide space at the rear of the sound field.
			DGTL GENERAL	Dolby Digital (5.1-channel)		
			DTS GENERAL	DTS		
9	Dolby/DTS SURROUND	NORMAL	PRO LOGIC/NORMAL	Analog, PCM, Dolby Digital in 2-channel	The built-in decoder precisely reproduces sounds and sound effects from sources. The highly efficient decoding process improves crosstalk and channel separation, and makes sound positioning smoother and more precise. In this program, the digital sound field processor is not turned on.	
			DOLBY DIGITAL/NORMAL	Dolby Digital (5.1-channel)		
			DTS DIGITAL SUR./NORMAL	DTS		
		ENHANCED	PRO LOGIC/ENHANCED	Analog, PCM, Dolby Digital in 2-channel		This program ideally simulates the multi-surround speaker systems of the 35-mm film theaters. Dolby Pro Logic decoding, Dolby Digital decoding or DTS decoding and digital sound field processing create precise effects without altering the original sound orientation. The surround effects produced by this sound field wrap around the viewer naturally from the back to the left and right, and toward the screen.
			DOLBY DIGITAL/ENHANCED	Dolby Digital (5.1-channel)		
			DTS DIGITAL SUR./ENHANCED	DTS		

Notes

- The “” indicator does not light up when selecting the sub-program “NORMAL” of the Dolby/DTS SURROUND program.
- If “CENTER SP” in the SET MENU is set to NON, no sound is output from the center speaker.
- The effect sound is output from the main speakers when a monaural source is played with CINEMA DSP program groups 4 (GAME) and 5 to 8.

MOVIE THEATER 1 and 2

Most commercially available movie software has 4-channel (left, center, right and surround) sound information encoded by Dolby Surround matrix processing and stored on the left and right tracks. These signals are processed by the Dolby Pro Logic decoder. The MOVIE THEATER programs are designed to recreate the spaciousness and delicate nuances of sound that tend to be lost in the encoding and decoding processes.

The 6-channel soundtracks found on 70-mm film produce precise sound field localization and rich, deep sound without using matrix processing. This unit's MOVIE THEATER 70 mm programs provide the same quality of sound and sound localization that 6-channel soundtracks do.

When the input source is analog, PCM or encoded with Dolby Digital in 2-channel

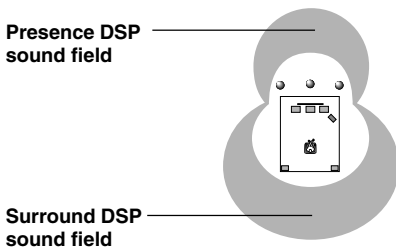

These programs express an immense sound field and a large surround effect. They also give depth to the sound from the main speakers to recreate the realistic sound of a Dolby Stereo theater.

70 mm SPECTACLE
70 mm SCI-FI
70 mm ADVENTURE
70 mm GENERAL

The built-in Dolby Digital or DTS decoder brings the professional-quality sound designed for movie theaters into your home. With the unit's MOVIE THEATER programs, you can recreate a dynamic sound that gives you the feeling of being at a public theater in your listening room by using Dolby Digital or DTS technology.

When the input source is encoded with Dolby Digital (5.1-channel) or DTS (Tri-Field CINEMA DSP)

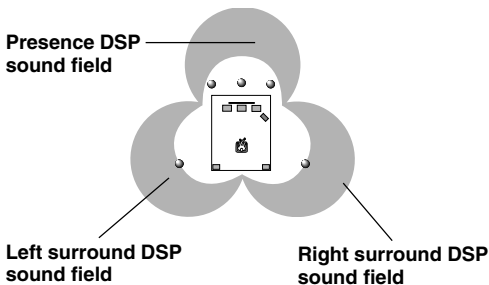

These programs use YAMAHA's tri-field DSP processing on each of the Dolby Digital or DTS signals for the front, left surround and right surround channels. This processing enables this unit to reproduce the immense sound field and surround expression of a Dolby Digital- or DTS-equipped movie theater without sacrificing the clear separation of all channels.

DGTL SPECTACLE
DTS SPECTACLE
DGTL SCI-FI
DTS SCI-FI
DGTL ADVENTURE
DTS ADVENTURE
DGTL GENERAL
DTS GENERAL



- If a Dolby Digital signal or DTS signal is input when the input mode is set to AUTO, the DSP program will be automatically switched to the Dolby Digital playback sound field or DTS playback sound field.



TROUBLESHOOTING

Refer to the chart below when the unit does not function properly. If the problem you are experiencing is not listed below or if the instruction below does not help, set this unit in the standby mode, disconnect the power cord and contact the nearest authorized YAMAHA dealer or service center.

■ General

Problem	Cause	Remedy	Refer to page
The unit fails to turn on when STANDBY/ON (or POWER) is pressed, or enters in the standby mode soon after the power has been turned on.	The power cord is not connected or the plug is not completely inserted.	Firmly connect the power cord.	18
	The IMPEDANCE SELECTOR switch on the rear panel is not fully set to the left or right position.	Set the switch fully to the left or right position when the unit is in the standby mode.	18
	The protection circuit has been activated.	Make sure all speaker wire connections on this unit and on all speakers are secure and that the wire for each connection does not touch anything other than its respective connection.	16, 17
No sound and/or no picture.	Incorrect input or output cable connections.	Connect the cables properly. If the problem persists, the cables may be defective.	12 – 15
	An appropriate input source has not been selected.	Select an appropriate input source with INPUT <I/> or 6CH INPUT (or the input selector buttons).	21
	The speaker connections are not secure.	Secure the connections.	16, 17
	The main speakers to be used have not been selected properly.	Select the main speakers with SPEAKERS A and/or B.	21
	The volume is turned down.	Turn up the volume.	22
	The sound is muted.	Press MUTE or any operation buttons to cancel a mute and adjust the volume.	22
	Digital signals other than PCM audio, Dolby Digital or DTS signal which this unit cannot reproduce are being input to this unit by playing a CD-ROM, etc.	Play a source whose signals this unit can reproduce.	—
The picture does not appear.	The output and input for the video are connected to different types of video jacks. HTR-5450 only	Make connections using the same type of jack (between composites, S-VIDEOS, or components) for both the input and output. HTR-5450 only	14, 15
The sound suddenly goes off.	The protection circuit has been activated because of a short circuit, etc.	Check the IMPEDANCE SELECTOR switch is set to the appropriate position and then turn the unit back on.	18
		Check the speaker wires are not touching each other and then turn the unit back on.	16, 17
	The sleep timer has functioned.	Turn on the power, and play the source again.	39
	The sound is muted.	Press MUTE or any operation buttons to cancel a mute and adjust the volume.	22
Only the speaker on one side can be heard.	Incorrect cable connections.	Connect the cables properly. If the problem persists, the cables may be defective.	12 – 17

Problem	Cause	Remedy	Refer to page
No sound from the effect speakers.	The sound effect is off.	Press EFFECT to turn it on.	25
	A Dolby Surround, Dolby Digital or DTS decoding DSP program is being used with material not encoded with Dolby Surround, Dolby Digital or DTS.	Select another DSP program.	47, 48
	A 96-kHz sampling digital signal is being input to this unit. HTR-5450 only		22
No sound from the center speaker.	The output level of the center speaker is set to minimum.	Raise the level of the center speaker.	37
	“CENTER SP” in the SET MENU is set to NON.	Select the appropriate mode for your center speaker.	33
	One of the Hi-Fi DSP programs (1 to 4) has been selected.	Select another DSP program.	47, 48
	The source encoded with a Dolby Digital or DTS signal does not have a center channel signal.		—
No sound from the rear speakers.	The output level of the rear speakers is set to minimum.	Raise the output level of the rear speakers.	37
	A monaural source is being played with the program 9.	Select another DSP program.	47, 48
No sound from the subwoofer.	“BASS OUT” in the SET MENU is set to MAIN when a Dolby Digital or DTS signal is being played.	Select SWFR or BOTH.	34
	“BASS OUT” in the SET MENU is set to SWFR or MAIN when a 2-channel source is being played.	Select BOTH.	34
	The source does not contain low bass signals (90 Hz and below).		—
Poor bass reproduction.	“BASS OUT” in the SET MENU is set to SWFR or BOTH and your system does not include a subwoofer.	Select MAIN.	34
	The output mode for each speaker (main, center or rear) in the SET MENU does not match your speaker configuration.	Select the appropriate output mode for each speaker based on the size of the speakers in your configuration.	33, 34
A “humming” sound can be heard.	Incorrect cable connections.	Firmly connect the audio plugs. If the problem persists, the cables may be defective.	12 – 15

Problem	Cause	Remedy	Refer to page
The volume level cannot be increased, or the sound is distorted.	The component connected to the REC OUT jacks of this unit is turned off.	Turn on the power to the component.	—
The effect and surround sounds cannot be recorded.	It is not possible to record the effect and surround sounds by a recording component.		31
A source cannot be recorded.	An analog source is being input during digital recording. HTR-5450 only	Input a digital source. HTR-5450 only	12 – 15
	A source component and recording component are not digitally connected to the unit. HTR-5450 only	Make digital connections. HTR-5450 only	
	A digital source is being input during analog recording.	Input an analog source.	
	A source component and recording component are not analog connected to the unit.	Make analog connections.	
The settings of the SET MENU and some other settings on this unit cannot be changed.	“9 MEM. GUARD” in the SET MENU is set to ON.	Select OFF.	39
This unit does not operate properly.	The internal microcomputer has been frozen by an external electric shock (such as lightning or excessive static electricity) or by a power supply with low voltage.	Disconnect the AC power cord from the outlet and then plug it in again after about 30 seconds.	—
The sound is degraded when listening with headphones connected to a tape deck or CD player that is connected to this unit.	This unit is in the standby mode.	Turn on the power of the unit.	—
There is noise interference from digital or high-frequency equipment, or the unit.	The unit is too close to the digital or high-frequency equipment.	Move the unit further away from such equipment.	—

■ Tuner

	Problem	Cause	Remedy	Refer to page
FM	FM stereo reception is noisy.	The characteristics of FM stereo broadcasts may cause this problem when the transmitter is too far away or the antenna input is poor.	Check the antenna connections. Try using a high-quality directional FM antenna.	26
			Use the manual tuning method.	27
	There is distortion, and clear reception cannot be obtained even with a good FM antenna.	There is multipath interference.	Adjust the antenna position to eliminate multipath interference.	26
	The desired station cannot be tuned in with the automatic tuning method.	The station is too weak.	Use the manual tuning method.	27
Use a high-quality directional FM antenna.			26	
	Previously preset stations can no longer be tuned in.	The unit has been disconnected for a long period.	Re-store the stations.	28
AM	The desired station cannot be tuned in with the automatic tuning method.	The signal is weak or the antenna connections are loose.	Tighten the AM loop antenna connections and orient it for best reception.	26
			Use the manual tuning method.	27
	There are continuous crackling and hissing noises.	Noises result from lightning, fluorescent lamps, motors, thermostats and other electrical equipment.	Use an outdoor antenna and a ground wire. This will help somewhat, but it is difficult to eliminate all noise.	26
	There are buzzing and whining noises (especially in the evening).	A TV set is being used nearby.	Move this unit away from the TV.	—

■ Remote control

	Problem	Cause	Remedy	Refer to page
	The remote control does not work nor function properly.	Wrong distance or angle.	The remote control will function within a maximum range of 6 m (20 feet) and no more than 30 degrees off-axis from the front panel.	7
		Direct sunlight or lighting (from an inverter type of fluorescent lamp, etc.) is striking the remote control sensor of this unit.	Reposition the unit.	7
		The batteries are weak.	Replace all batteries with new ones.	3
	The unit or other component cannot be controlled.	The component to be controlled has not been selected.	Press one of the component selector buttons, corresponding to the component to be controlled.	40
		The remote control cannot control system components.		—
		The manufacturer code has not been set up properly.	Enter the code again.	45
			Try setting another code for the same manufacturer.	
	Depending on the manufacturer or the model, some components cannot be controlled with this unit's remote control even though the code has been set up properly.	Use the original remote control supplied with your component.	—	

After this unit has been exposed to a strong external electric shock (such as lightning and strong static electricity) or if you mishandle the operation of this unit, it may not function properly. In these cases, set this unit in the standby mode, disconnect the power cord, plug it back in after 30 seconds, and start operating.



SPECIFICATIONS (HTR-5450)

AUDIO SECTION

- Minimum RMS Output Power for Main, Center, Rear
20 Hz to 20 kHz, 0.06% THD, 8 ohms
[U.S.A. and Canada models] 80 W
[Singapore, China and General models] 70 W
- Maximum power
1 kHz, 0.7% THD, 8 ohms 100 W
- Maximum Power (EIAJ)
[China and General models]
1 kHz, 10% THD, 8 ohms 100 W
- Dynamic Power (IHF)
8/6/4/2 ohms
[U.S.A. and Canada models] 105/125/145/165 W
[China and General models] 95/115/135/155 W
- Damping Factor
20 Hz to 20 kHz, 8 ohms 60 or more
- Frequency Response
CD, etc. to Main L/R (1 kHz, 150 mV, 8 ohms)
..... 20 Hz to 20 kHz, ± 0.5 dB
- Total Harmonic Distortion
CD, etc. to Main L/R (Effect Off, 20 Hz to 20 kHz, 30 W, 8 ohms)
..... 0.025% or less
- Signal to Noise Ratio (IHF-A Network)
CD, etc. to Main L/R (Effect Off, 250 mV, shorted)
..... 100 dB or more
- Residual Noise (IHF-A Network)
Main L/R 150 μ V or less
- Channel Separation
CD, etc. to MAIN L/R (1 kHz) 60 dB
(10 kHz) 45 dB
- Tone Control (Main L/R)
BASS Boost/Cut ± 10 dB/50 Hz
TREBLE Boost/Cut ± 10 dB/20 kHz
- Phones Output 490 mV/390 ohms
- Input Sensitivity
CD, etc 150 mV/47 kohms
6CH INPUT 150 mV/47 kohms
- Maximum Input Signal
CD, etc. (1 kHz, 0.5% THD) 2.2 V or more
- Output Level
REC OUT 150 mV/1.2 kohms
SUBWOOFER 4.0 V/1.2 kohms

VIDEO SECTION

- Video Signal Type
[U.S.A., Canada, China and General models] NTSC
[Australia and Singapore models] PAL
- Composite Video Signal Level 1 Vp-p/75 ohms
- S-Video Signal Level
Y 1 Vp-p/75 ohms
C 0.286 Vp-p/75 ohms
- Signal to Noise Ratio 50 dB or more
- Frequency Response (MONITOR OUT)
Composite, S-Video 5 Hz to 10 MHz, -3 dB

FM SECTION

- Tuning Range
[U.S.A. and Canada models] 87.5 to 107.9 MHz
[Australia, Singapore, China and General models]
..... 87.50 to 108.00 MHz
- 50 dB Quieting Sensitivity (IHF, 100% mod.)
Mono/Stereo 2.0 μ V (17.3 dBf) /25 μ V (39.2 dBf)
- Alternate Channel Selectivity (400 kHz) 70 dB
- Signal to Noise Ratio (IHF)
Mono/Stereo 76 dB/70 dB
- Harmonic Distortion (1 kHz)
Mono/Stereo 0.2%/0.3%
- Stereo Separation (1 kHz) 48 dB
- Frequency Response 20 Hz to 15 kHz, +0.5, -2.0 dB

AM SECTION

- Tuning Range
[U.S.A. and Canada models] 530 to 1710 kHz
[Australia and Singapore models] 531 to 1611 kHz
[China and General models]
10 kHz step 530 to 1710 kHz
9 kHz step 531 to 1611 kHz
- Usable Sensitivity 300 μ V/m

GENERAL

- Power Supply
[U.S.A. and Canada models] AC 120 V/60 Hz
[Australia model] AC 240 V/50 Hz
[Singapore model] AC 230 V/50 Hz
[China model] AC 220 V/50 Hz
[General model] AC 110/120/220/240 V, 50/60 Hz
- Power Consumption
[U.S.A. model] 240 W
[Australia, Singapore, China and General models]
..... 250 W
[Canada model] 250 W/320 VA
Standby Mode
[U.S.A. and Canada models] 0.90 W
[Australia and Singapore models] 0.96 W
- Maximum Power Consumption
[General model only]
5CH, 10% THD 500 W
- AC Outlets
2 (SWITCHED)
[U.S.A., Canada and Singapore models] Total 100 W maximum
[China and General models] Total 50 W maximum
1 (SWITCHED)
[Australia model] Total 100 W maximum
- Dimension (W x H x D) 435 x 151 x 390 mm
- Weight 10.0 kg
- Accessories Remote Control
..... Batteries
..... AM loop antenna
..... Indoor FM antenna
..... Quick Reference Card
..... Connection Guide

* Specifications are subject to change without notice.



SPECIFICATIONS (HTR-5440)

AUDIO SECTION

- Minimum RMS Output Power for Main, Center, Rear
20 Hz to 20 kHz, 0.06% THD, 8 ohms 65 W
- Maximum power
1 kHz, 0.7% THD, 8 ohms
[U.S.A. and Canada models] 80 W
[Europe, U.K., Australia, Singapore, China and
General models] 75 W
- DIN Standard Output Power
[Europe model only]
1 kHz, 0.7% THD, 4 ohms 95 W
- IEC Output Power
[Europe model only]
1 kHz, 0.06% THD, 8 ohms 67 W
- Maximum Power (EIAJ)
[China and General models]
1 kHz, 10% THD, 8 ohms 95 W
- Dynamic Power (IHF)
8/6/4/2 ohms
[U.S.A. and Canada models] 95/115/135/155 W
[China and General models] 90/110/130/150 W
- Damping Factor
20 Hz to 20 kHz, 8 ohms 60 or more
- Frequency Response
CD, etc. to MAIN L/R 20 Hz to 20 kHz, ± 5 dB
- Total Harmonic Distortion
CD, etc. to MAIN L/R (Effect Off, 20 Hz to 20 kHz, 30 W, 8 ohms)
..... 0.025% or less
- Signal to Noise Ratio (IHF-A Network)
CD, etc. to MAIN L/R (Effect Off, 250 mV, shorted)
..... 100 dB or more
- Residual Noise (IHF-A Network)
Main L/R 150 μ V or less
- Channel Separation
CD, etc. to MAIN L/R (1 kHz) 60 dB
(10 kHz) 45 dB
- Tone Control (Main L/R)
BASS Boost/Cut ± 10 dB/50 Hz
TREBLE Boost/Cut ± 10 dB/20 kHz
- Phones Output 470 mV/390 ohms
- Input Sensitivity
CD, etc 150 mV/47 kohms
6CH INPUT 150 mV/47 kohms
- Maximum Input Signal
CD, etc. (1 kHz, 0.5% THD) 2.2 V or more
- Output Level
REC OUT 150 mV/1.2 kohms
SUBWOOFER 4.0 V/1.2 kohms

VIDEO SECTION

- Video Signal Type
[U.S.A., Canada, China and General models] NTSC
[Europe, U.K., Australia and Singapore models] PAL
- Composite Video Signal Level 1 Vp-p/75 ohms
- Signal to Noise Ratio 50 dB or more
- Frequency Response (MONITOR OUT)
Composite 5 Hz to 10 MHz, -3 dB

FM SECTION

- Tuning Range
[U.S.A. and Canada models] 87.5 to 107.9 MHz
[Europe, U.K., Australia, Singapore, China and
General models] 87.50 to 108.00 MHz
- 50 dB Quieting Sensitivity (IHF, 100% mod.)
Mono/Stereo 2.0 μ V (17.3 dBf) /25 μ V (39.2 dBf)
- Alternate Channel Selectivity (400 kHz) 70 dB
- Signal to Noise Ratio (IHF)
Mono/Stereo 76 dB/70 dB
- Harmonic Distortion (1 kHz)
Mono/Stereo 0.2%/0.3%
- Stereo Separation (1 kHz) 48 dB
- Frequency Response 20 Hz to 15 kHz, $+0.5, -2.0$ dB

AM SECTION

- Tuning Range
[U.S.A. and Canada models] 530 to 1710 kHz
[Europe, U.K., Australia and Singapore models] 531 to 1611 kHz
[China and General models]
10 kHz step 530 to 1710 kHz
9 kHz step 531 to 1611 kHz
- Usable Sensitivity 300 μ V/m

GENERAL

- Power Supply
[U.S.A. and Canada models] AC 120 V/60 Hz
[Australia model] AC 240 V/50 Hz
[Europe, U.K., and Singapore models] AC 230 V/50 Hz
[China model] AC 220 V/50 Hz
[General model] AC 110/120/220/240 V, 50/60 Hz
- Power Consumption
[U.S.A. model] 200 W
[Canada model] 210 W/280 VA
[Europe, U.K., Australia, Singapore China and General models]
..... 210 W
Standby Mode
[U.S.A. and Canada models] 0.90 W
[Europe, U.K., Australia, Singapore and China models] 0.96 W
- Maximum Power Consumption
[General model only]
5-ch, 10% THD 480 W
- AC Outlets
2 (SWITCHED)
[U.S.A., Canada and Singapore models] Total 100 W maximum
[China and General models] Total 50 W maximum
1 (SWITCHED)
[Australia model] Total 100 W maximum
- Dimension (W x H x D) 435 x 151 x 390 mm
- Weight 9.5 kg
- Accessories Remote Control
..... Batteries
..... AM loop antenna
..... Indoor FM antenna
..... Quick Reference Card
..... Connection Guide

* Specifications are subject to change without notice.



GLOSSARY

■ Dolby Surround

Dolby Surround uses a four analog channel recording system to reproduce realistic and dynamic sound effects: two left and right main channels (stereo), a center channel for dialog (monaural), and a rear channel for special sound effects (monaural). The rear channel reproduces sound within a narrow frequency range.

Dolby Surround is widely used with nearly all video tapes and laser discs, and in many TV and cable broadcasts as well. The Dolby Pro Logic decoder built into this unit employs a digital signal processing system that automatically stabilizes the volume on each channel to enhance moving sound effects and directionality.

■ Dolby Digital

Dolby Digital is a digital surround sound system that gives you completely independent multi-channel audio. With three front channels (left, center and right), and two rear stereo channels, Dolby Digital provides five full-range audio channels. With an additional channel especially for bass effects, called LFE (low frequency effect), the system has a total of 5.1 channels (LFE is counted as 0.1 channel). Using two-channel stereo for the rear speakers, more accurate moving sound effects and surround sound environment are possible than with Dolby Surround. The wide dynamic range (from maximum to minimum volume) reproduced by the five full-range channels and the precise sound orientation generated using digital sound processing provide listeners with previously unheard of excitement and realism.

With this unit, any sound environment from monaural up to a 5.1-channel configuration can be freely selected for your enjoyment.

■ DTS (Digital Theater Systems) Digital Surround

DTS digital surround was developed to replace the analog soundtracks of movies with a six-channel digital sound track, and is now rapidly gaining popularity in movie theaters around the world. Digital Theater Systems Inc. has developed a home theater system so that you can enjoy the depth of sound and natural spatial representation of DTS digital surround in your home. This system is practically distortion-free, clear 6-channel sound (technically, a left, right and center channels, two rear channels, plus an LFE 0.1 channel as a subwoofer, for a total of 5.1 channels).

■ LFE 0.1 channel

This channel is for the reproduction of low bass signals. The frequency range for this channel is 20 Hz to 120 Hz. This channel is counted as 0.1 because it only enforces a low frequency range compared to the full-range reproduced by the other 5 channels in a Dolby Digital or DTS 5.1 channel systems.

■ CINEMA DSP

Since the Dolby Surround and DTS systems were originally designed for use in movie theaters, their effect is best felt in a theater having many speakers and designed for acoustic effects. Since home conditions, such as room size, wall material, number of speakers, and so on, can differ so widely, it's inevitable that there are differences in the sound heard as well. Based on a wealth of actually measured data, YAMAHA CINEMA DSP uses YAMAHA original sound field technology to combine Dolby Pro Logic, Dolby Digital and DTS systems to provide the visual and audio experience of movie theater in the listening room of your own home.

■ SILENT CINEMA

YAMAHA has developed a natural, realistic sound effect DSP algorithm for headphones. Parameters for headphones have been set for each sound field so that accurate representations of all the sound field programs can be enjoyed on headphones.

■ Virtual CINEMA DSP

YAMAHA has developed a virtual CINEMA DSP algorithm that allows you to enjoy DSP sound field surround effects even without any rear speakers by using virtual rear speakers.

It is even possible to enjoy virtual CINEMA DSP in a minimum two-speaker system that does not include a center speaker.

■ S VIDEO signal **HTR-5450 only**

With S VIDEO signal system, the video signal normally transmitted using a pin cable is separated and transmitted as the Y signal for the luminance and the C signal for the chrominance through the S VIDEO cable. Using the S VIDEO jack eliminates video signal transmission loss and allows recording and playback of even more beautiful images.

■ PCM (Linear PCM)

Linear PCM is a signal format under which an analog audio signal is digitized, recorded and transmitted without using any compression. This is used as a method of recording CDs and DVD audio. The PCM system uses a technique for sampling the size of the analog signal per very small unit of time. Standing for “pulse code modulation”, the analog signal is encoded as pulses and then modulated for recording.

■ Sampling frequency and number of quantized bits **HTR-5450 only**

When digitizing an analog audio signal, the number of times the signal is sampled per second is called the sampling frequency, while the degree of fineness when converting the sound level into a numeric value is called the number of quantized bits.

The range of rates that can be played back is determined based on the sampling rate, while the dynamic range representing the sound level difference is determined by the number of quantized bits. In principle, the higher the sampling frequency, the wider the range of frequencies that can be played back, and the higher the number of quantized bits, the more finely the sound level can be reproduced.

■ I/O ASSIGN (SET MENU)

Although component is normally connected according to jack names shown on the rear panel, this unit includes a function that assigns jacks according to the component being connected. If the component being used differs from the component name shown for this unit’s digital jacks, it is possible to assign jacks according to the component being connected. This makes it possible to change the jack assignment and effectively connect more component.



INDEX

A		
AC outlets	18	
Antennas	26	
B		
BALANCE	22	
BGV function	22	
C		
CBL/SAT mode	44	
CD mode	42	
CINEMA DSP	47, 56	
Connections		
Antennas	26	
Audio components (MD recorder, CD recorder and CD player)	12	
External decoder	12	
Power supply cords	18	
Speakers	16	
Video components (DVD player, VCR and TV/digital TV or cable TV/satellite tuner)	14	
D		
Delay time	37	
Display	8	
DISPLAY SET (SET MENU)	36	
DOLBY D. SET (SET MENU)		
D-RANGE	35	
LFE LEVEL	35	
Dolby Digital	56	
Dolby Surround (Dolby Pro Logic)	56	
DSP program		
CINEMA DSP program	47	
Hi-Fi DSP program	47	
DTS	56	
DTS SET (SET MENU)	36	
Dust protection cap	12	
DVD/LD mode	43	
DVD MENU mode	43	
E		
External decoder	12	
F		
Front panel	4	
H		
HP TONE CTRL (SET MENU)	34	
I		
IMPEDANCE SELECTOR switch	18	
INPUT MODE (SET MENU)	35	
Input modes	23	
I/O ASSIGN (SET MENU)	34, 57	
L		
LFE	35, 36, 56	
M		
Manufacturer codes	45, i	
Memory back-up	28, 33, 38	
MEM. GUARD (SET MENU)	36	
Muting	22	
P		
Package contents	3	
PCM	57	
Playing	21	
Power supply cords	18	
Preset stations		
Exchanging preset station	30	
To recall a preset station	29	
Presetting tuning		
Automatic preset tuning	28	
Manual preset tuning	29	
R		
Rear panel	9	
Recording	31	
Remote control		
Basic operation	6	
Batteries	3	
Operation range	7	
Setup codes	45	
S		
Sampling frequency (HTR-5450 only)	22, 57	
SET MENU	32	
SILENT CINEMA	25, 56	
Sleep timer	39	
SP DLY TIME (SET MENU)	36	
Speaker		
Output levels (TIME/LEVEL mode)	37	
Placement	10	
Output balance (test tone)	19	
SPEAKER SET (SET MENU)		
BASS OUT	34	
CENTER SP	33	
MAIN LVL	34	
MAIN SP	33	
REAR LR SP	33	
Subwoofer	17	
S VIDEO (HTR-5450 only)	57	
T		
TAPE/MD mode	41	
Test tone	19	
Tuning		
Automatic tuning	27	
Manual tuning	27	
TV mode	44	
V		
VCR mode	44	
Virtual CINEMA DSP	25, 56	

LIST OF MANUFACTURER'S CODES

LISTES DES CODES FABRICANT

TV							
A-Mark	1161	Elin	1001	Kaypani	1021	Penny	0161, 0361, 0521, 0531, 0621, 0731, 0751, 0761, 0781, 0791, 0861, 0931, 0941, 1031, 1041, 1111, 1151, 1161
A Tandy	0941	Elta	0331	Kenwood	0361, 1031, 1111	Peony	1561, 1621
Abex	1151	Emerson	0001, 0021, 0061, 0071, 0081, 0091, 0111, 0811, 0821, 0831, 0841, 0851, 0861, 0871, 0901, 0921, 0941, 0981, 1011, 1031, 1051, 1081, 1091	Kloss	0631, 0721, 1131	Philco	0361, 0581, 0591, 0601, 0611, 0631, 0961, 1031, 1111
Admira	1141			KTV	0921, 0941, 1011, 1051, 1111	Philips	0101, 0401, 1001
Adventura	1131			Leyco	1001	Phonola	1001
Aiko	1121			Liesenk & Tter	1001	Pilot	0941, 1031, 1111
Akai	0331, 1101, 1111			Lloytron	0941	Pioneer	0511, 0551, 0871
Alba	0431			Loewe	1001	Portland	0941, 1031, 1121
Alleron	1091	Envision	0361, 1111	Logik	0991, 1771	Priceclub	0931
Ambassador	1081	Erres	1001	Luxman	0351, 0971	Prism	0751
Amstrad	0481, 1081	Etron	0331	Lxi	0101, 0621, 0761, 0861, 0981	Proscan	0761
Anam	0251, 1041, 1051, 1061, 1071	Ferguson	1001	Magnavox	0101, 0341, 0391, 0401, 0411, 0421, 0581, 0591, 0601, 0611, 0631, 0661, 0961, 1111	Protech	1001
Anam National	1041	Finlux	1001			Proton	0501, 0861, 0941, 1021, 1161
AOC	0361, 1021, 1031, 1111, 1161	Fisher	0171, 0801, 0981			Pulsar	0891
Archer	1161	Formenti	0441	Majestic	0991	Pulser	1031
Audiosonic	1001	Formonti	1001	Marantz	0101, 0221, 0361, 1001, 1111	Quasar	0251, 0751, 1041
Audiovox	1051, 1161	Fortress	1141			Quelle	1001
Aiwa	1481	Fujitsu	1091	Mark	1001	Radio Shack	0541, 0941, 1031, 1051, 1151
Bauer	0441	Funai	1051, 1091, 1501, 1521	Matsui	0271, 0331, 1001	Radiola	1001
Baur	1001	Futuretech	1051	Mediator	1001	RCA	0051, 0141, 0151, 0181, 0411, 0491, 0531, 0761, 0771, 0871, 1031
Beijing	1511, 1551, 1561	GE	0131, 0161, 0201, 0751, 0761, 0771, 0781, 0791, 0811, 0861, 1041	Megatron	0691, 0861, 1161	Realistic	0541, 0861, 0941, 0971, 0981, 1031, 1051, 1111, 1151
Belcor	1031			MEI	1011	Rhapsody	1011
Bell & Howell	0981, 0991	GEC	0271, 1001	M Electronic	1001	R-line	1001
Beon	1001	Gemini	0391	Memorex	0331, 0571, 0861, 0971, 0981, 0991, 1771	Runco	0891, 1111
Bradford	1051	Genexxa	0431			Saisho	0331, 1081
Brockwood	1031	Gibraltar	0891, 1031, 1111	Metz	1791, 1831, 1891, 1901, 1911, 1921, 1931, 1941	Sampo	0361, 0941, 1021, 1111, 1151
Broksonic	1161	GoldStar	0031, 0121, 0351, 0411, 0731, 0741, 0861, 0941, 0971, 1001, 1031, 1111, 1151			Samsung	0331, 0341, 0351, 0361, 0861, 0931, 0941, 0971, 1001, 1031, 1111, 1151
Bush	1001			MGA	0361, 0561, 0571, 0861, 1031, 1111	Samsux	0941
Candle	0351, 0361, 0961, 0971, 1111, 1131	Goodmans/Tashiko	0271, 0661, 1001	Midland	0751, 0761, 0891, 0941, 1151	Sanyo	0171, 0231, 0271, 0661, 0801, 0911, 0981, 1231, 1251, 1261
Capehart	1021	Granada	1001	Mitsubishi	0221, 0321, 0561, 0571, 0661, 0861, 1031, 1101, 1381	SBR	1001
Carver	0101	Grundig	1781, 1791, 1801, 1811, 1821, 1831, 1841, 1851, 1861, 1871, 1881	Montgomery	1091	Schneider	1001
Cathay	1001			Motorola	1041, 1141	Scimitsu	1031
Celebrity	0951			MTC	0351, 0361, 0881, 0931, 0971, 1011, 1031, 1111	Scotch	0861
Centurion	0411	Gunpy	1051, 1091			Scott	0831, 0861, 0941, 1031, 1051, 1091
Changhong	1541, 1551, 1561, 1621	H/K	0721	Multitech	0881, 1051	Sears	0101, 0161, 0171, 0351, 0481, 0521, 0621, 0761, 0801, 0861, 0971, 0981, 1091
Citizen	0351, 0361, 0921, 0931, 0941, 0961, 0971, 1111, 1121, 1131	Hallmark	0861	NAD	0551, 0621, 0861	Shanghai	1561, 1681
Clairtone	1011	Hanseatic	1001	NEC	0241, 0351, 0361, 0661, 0971, 1031, 1111, 1321, 1711	Sharp	0461, 0471, 0541, 0661, 0911, 0941, 1141
Clarivox	1001	Harvard	1051, 1061			Shogun	1031
Concerto	0351, 0971	Hinari	1001, 1091	Neckermann	1001	Signature	0991, 1771
Conrowa	1751	Hitachi	0181, 0351, 0671, 0681, 0691, 0701, 0711, 0871, 0941, 0971, 1351	Nei	1001		
Contec	0901, 0911, 1011, 1051			Nikkai	0271, 0431, 1001, 1151		
Corando	0941	Hypson	1001				
Craig	0251, 1051	Ima	1051	Nikko	0861, 1111, 1121		
Crown	0941, 1051	Indiana	1001	Novabeam	0721		
Curtis Mathes	0161, 0361, 0931, 0941, 0981, 1111	Infinity Reference	0101	NTC	1121		
CXC	1051	Interfunk	1001	Onwa	1051		
Daewoo	0291, 0301, 0331, 0721, 0941, 1001, 1031, 1121, 1191, 1531, 1581, 1591, 1601	ITT	0611	Optimus	0551		
Dansai	1001	Janeil	1131	Optonica	0541, 1("1		
Daytron	0941, 1031	JBL	0101	Orion	0831, 1001		
Decca	0271, 1001	JCB	0951	Osaki	0271, 1151		
Dixi	0331, 1001, 1071	Jensen	0311	Otto Versand	1001		
Dumont	0891, 1031	Jinxing	1531, 1541, 1551, 1561, 1571, 1621, 1631, 1641, 1651, 1691, 1731	Panasonic	0101, 0191, 0251, 0751, 1041, 1311, 1371, 1431		
Dynatech	0881						
Dynaband	0951, 1011	JVC (Victor)	0261, 0281, 0641, 0651, 0661, 0841	Panda	1541, 1721		
Electroband	0941	Kawasho	0901				
Electrohome	0941						
Electron	0941						

Simpson 0581, 0961
 Solavox 1151
 Sonoko 1001
 Sontec 1001
 Sony 0371, 0451, 0661, 0841, 0951, 1281, 1441
 Soundesign 0861, 0961, 1051, 1091
 Soundwave 1001
 Spectricon 1161
 Squareview 0481
 SSS 1031, 1051
 Star-lite 1051
 Suprem 0951
 Supre-macy 1131
 Surpa 0351, 0971
 Sylvania 0101, 0361, 0441, 0581, 0591, 0601, 0611, 0631, 0961, 1111
 Symphonic 0481
 Sysline 1001
 Tandy 0271, 0431, 1141
 Tatung 0271, 0881, 1001, 1041, 1161
 Tcl 1561, 1631, 1701
 Technics 0751
 Techwood 0351, 0751, 0971
 Teknika 0101, 0351, 0571, 0931, 0941, 0961, 0971, 0991, 1031, 1051, 1091, 1121, 1131, 1771
 Teletech 0331
 Tera 0501
 Thakral 1671
 Thorn 1001
 TMK 0351, 0861, 0971, 1081
 Toshiba 0381, 0521, 0621, 0661, 0931, 0981, 1301
 Tosonic 1011
 Totevision 0941
 Trical 0911
 Universal 0781, 0791
 Universum 1001
 Vector Research 0361, 1111
 Vestel 1001
 Video Concept 1101
 Vidikron 0101, 0211
 Vidtech 0861, 1031
 Viking 1131
 Wards 0101, 0361, 0451, 0541, 0581, 0591, 0601, 0611, 0771, 0781, 0791, 0861, 0971, 0991, 1031, 1091, 1111, 1771
 Watson 1001
 Xogego 1611, 1621, 1661, 1741, 1761
 Yamaha 0361, 1031, 1111
 Yoko 1001
 Zenith 0011, 0041, 0891, 0991, 1771
 Zonda 1161

CABLE

ABC 0256, 0376
 Antronix 0136
 Archer 0136, 0286
 BBT 0076
 Cabletime 0166
 Cablevision 0196
 Colour Voice 0306, 0346
 Comtronics 0216, 0276
 Eagle Comtronics 0276
 Eastern 0066
 Electricord 0206
 Electus 0266
 GE 0116, 0126
 GEC Cable System 0196
 Hamlin H5 0676
 Hamlin H6 0666
 Hamlin H6S 0656
 Hamlin H8 0646
 Hamlin H9 0636
 Jerrold 0256
 Jerrold 400L 0626
 Jerrold 450L 0616
 Jerrold 550 0606
 Jerrold Osd Catv 0596
 Jerrold Sprucer 0436
 Magnavox/Philips 0416, 0426
 Mamm 0296
 Memorex 0386
 Movie Time 0146, 0206
 Northcoast 0016
 NSC 0146
 Oak 0106
 Oak Sigma 450 0546
 Oak Sigma 550 0536
 Panasonic TZ 120/130 0476
 Panasonic TZ 170/180 0446
 Panasonic TZ140 0466
 Panasonic TZ150/160 0456
 Paragon 0386
 Philips 0036, 0216, 0306, 0316, 0326, 0336, 0346
 Pioneer 0006, 0086
 Pioneer BR50 0846
 Pioneer BR60/70/80/81/82 0696
 Pioneer BR90 0556
 Pulsar 0386
 RCA Digital Satellite System 0396, 0406
 Realistic 0136
 Regency/Eastern 0686
 Runco 0386
 Samsung 0276
 Scientific Atlanta 175/475 0576
 Scientific Atlanta 75 0366, 0586
 Scientific Atlanta 8650 0566
 Signal 0276
 SL Marx 0276
 Spectavision 0236
 Standard Components 0186
 Starcom V 0256
 Stargate 0276
 Sylvania/Texscan 0376, 0496
 Teknika 0176
 Teleservice 0056
 Televue 0276
 Texscan 0186, 0376
 TFC 0026
 Tocom 0226, 0356
 Tocom 5503A 0526
 Tocom 5503VIP/5507 0516
 Tocom TC56 0506
 Toshiba 0386
 Tudi 0046

Unika 0136
 Universal 0136, 0156, 0206, 0286
 Videoway 0096
 Viewstar 0216
 Zenith 0246, 0386, 0486

SATELLITE TUNER

Alpha Star 0826
 Chaparral 0756
 Echostar 0836
 General Instrument 0776
 HTS 0836
 Hughes Network Systems 0816
 Jerrold 0776, 0786
 Panasonic 0806
 Primestar 0776, 0786
 RCA 0766
 Sony 0796

VCR

A Tandy 0902
 Adventura 0992
 Aiko 0982
 Aiwa 0992
 Akai 0262, 0942, 0952, 0962, 0972
 American High 0932
 Amstrad 0992
 ASA 0002, 0912
 Asha 0922
 Audio Dynamics 0202
 Audiovox 0912
 Beaumark 0922
 Bell & Howell 0902
 Blaupunkt 0412
 Broksonic 0872, 0882, 0892
 Bush 0852
 Calix 0912
 Canon 0862, 0932
 CCE 0852, 0982
 Citizen 0912, 0982
 Colt 0852
 Craig 0832, 0842, 0852, 0912, 0922
 Curtis Mathes 0662, 0822, 0932
 Cybernex 0922
 Daewoo 0802, 0812, 0982
 DBX 0202
 Dynatech 0472, 0992
 Electrohome 0912
 Electrophonic 0912
 Emerex 0792
 Emerson 0072, 0132, 0142, 0152, 0162, 0172, 0182, 0192, 0212, 0702, 0712, 0722, 0732, 0742, 0752, 0762, 0772, 0782, 0872, 0882, 0892, 0912, 0952, 0992, 1072
 Finlux 0002, 0992
 Fisher 0682, 0692, 0842, 0902
 Fuji 0672, 0932
 Funai 0992
 Garrard 0992
 GE 0662, 0822, 0932
 Go Video 0642, 0652
 GoldStar 0082, 0632, 0912
 Goodmans 0402
 Gradiente 0992
 Granda 0612, 0902
 Grundig 0002
 H/K 1082

Harley Davidson 0992
 Harmon/Kardon 0632, 1082
 Harwood 0752, 0852
 Headquarter 0612
 HI-Q 0842
 Hinari 0852
 Hitachi 0102, 0562, 0572, 0582, 0592, 0602, 0992
 ITT 0942
 JVC (Victor) 0202, 0522, 0532, 0542, 0552
 Kenwood 0202, 0542, 0612, 0632, 0902
 KLH 0852
 Kodak 0912, 0932
 Lloyd 0992
 Logik 0852
 Luxor 0942
 LXI 0022, 0912
 Magnavox 0002, 0482, 0492, 0502, 0512, 0932
 Magnin 0922
 Marantz 0002, 0202, 0402, 0632, 0932
 Marta 0912
 Matsui 0722
 Matsushita 0932
 MEI 0222, 0932
 Memorex 0232, 0242, 0472, 0512, 0612, 0842, 0902, 0912, 0922, 0932, 0992
 MGA 0762, 0952
 MGA Technology 0922
 Minolta 0592, 0602
 Mitsubishi 0452, 0462, 0542, 0762, 0952, 1082
 Motorola 0472, 0932
 MTC 0922, 0992
 Multitech 0852, 0992
 NAD 0442
 NEC 0122, 0202, 0292, 0422, 0432, 0542, 0632
 Nikko 0912
 Noblex 0922
 Olympus 0412, 0932
 Optimus 0442, 0472, 0912
 Optonica 0402
 Orion 0212, 0722, 0742, 0772
 Osaki 0912
 Panasonic 0012, 0052, 0092, 0222, 0372, 0382, 0392, 0412, 0932
 Penny 0202, 0432, 0602, 0632, 0692, 0912, 0922, 0932
 Pentax 0592, 0602
 Perdio 0992
 Philco 0002, 0932
 Philips 0002, 0282, 0402, 0492, 0932
 Pilot 0912
 Pioneer 0442, 0542
 Proscan 1002, 1012, 1022, 1032, 1042, 1052, 1062
 Pulsar 0512
 Quarter 0612
 Quartz 0272, 0612
 Quasar 0382, 0392, 0932
 Radio Shack 0912, 0992
 Radix 0912
 Randex 0912

RCA	0112, 0382, 0392, 0482, 0592, 0602, 0662, 0822, 0942
Realistic	0402, 0472, 0612, 0682, 0842, 0902, 0912, 0922, 0932, 0992
Ricoh	0352, 0362
Saisho	0212, 0582, 0722, 0732, 0742, 0772
Salora	0612, 0762
Samsung	0212, 0312, 0922, 0962
Sanky	0472, 0512
Sansui	0292, 0542, 0832
Sanyo	0242, 0612, 0842, 0902, 0922
SBR	0002, 0282
Schneider	0852
Scott	0342, 0712, 0762, 0872, 0882, 0892
Sears	0302, 0592, 0602, 0612, 0682, 0692, 0842, 0902, 0912, 0932
Sharp	0402, 0472
Shintom	0852
Shogun	0922
Singer	0852
Sony	0032, 0332, 0352, 0362, 0672, 0792, 0932
STS	0602
Sunpak	0352
Sylvania	0002, 0492, 0502, 0762, 0932, 0992
Symphonic	0992
Tandy	0992
Tashiko	0712, 0992
Teac	0992
Technics	0932
Teknika	0322, 0912, 0932, 0992
Telefunken	0252
TMK	0212, 0732, 0772, 0922
Toshiba	0062, 0302, 0342, 0622, 0682, 0712, 0762
Totevision	0912, 0922
Unitech	0922
Vector Research	0202, 0432, 0632
Video Concepts	0202, 0432, 0632, 0952
Wards	0322, 0402, 0472, 0482, 0602, 0712, 0842, 0852, 0922, 0932, 0992
Yamaha	0202, 0632
Zenith	0042, 0362, 0512, 0672

RCA	0308
Samsung	0148
Sharp	0068
Sony	0028
Technics	0048
Thomson	0328
Toshiba	0088, 0248
Yamaha	0008, 0048, 0188, 0248
Zenith	0248

LD PLAYER

Aiwa	0157
Denon	0147
Disco Vision	0017
Funai	0157
Hitachi (E)	0017
Kenwood	0087, 0107
Magnavox	0027
Marantz	0027
Mitsubishi	0137
NAD	0137
Panasonic	0077, 0177
Philips	0027
Pioneer	0037, 0017, 0137
RCA	0167
Realistic	0157
Sharp	0127
Sony	0047, 0057, 0117
Victor	0097
Yamaha	0007, 0067

CD PLAYER

Acoustic Research	1295
ADC	0025, 0065
Adcom	0205, 0255, 1015
ADS	0265
Aiwa	0295, 0945, 1035, 1055
Akai	0175, 0485, 0535
Alpine	1215, 1305
Audio-Technica	0545
BSR	0245, 0655, 0775
California Audio Lab	0055
Capetronic	1205
Carrera	0245
Carver	0285, 1135
Casio	0345
Crown	0185
Curtis Mathes	0345
Denon	0275, 0875, 0885
Deual (E)	0505
Dynamic Bass (H)	0555
Emerson	0205, 0325, 1105
Eroica	1275
Fisher	0095, 0555, 0925, 1005
Garrard	0365
Genexxa	0305, 0325, 1105
GoldStar	1225, 1265, 1135, 1335
H/K	0105, 0175, 0465, 0995
Hitachi	0195, 0505, 0205, 0815
Inkel	0115, 0395
JVC (Victor)	0315
Kenwood	0045, 0095, 0405, 0585, 0725, 0735, 0745, 0755, 0895
Kyocera	0025
Luxman	0075, 0425, 0675, 0705, 0715, 0985
Magnavox	0165, 0215, 0645, 0955

Marantz	0215, 0235, 0375, 0785, 1345
McIntosh	0355, 1085
MCS	0905, 1315
Memorex	0205, 0225, 0235, 0305, 0325, 1105
MGA	0135
Mission	0215
Mitsubishi	0135, 0445
MTC	1255
NAD	0035, 0615, 0685, 0695
Nakamichi	0125, 0435, 0515
NEC	0255, 0905, 0965
Nikko	0545, 1005
Onkyo	0155, 0455, 0495, 0805, 1155
Optimus	0225, 0245, 0555, 0595, 0845, 0855, 0865, 0895, 0935
Panasonic	0055, 0825, 1095, 1125
Penny	0905
Philips	0165, 0215
Pioneer	0305, 0935, 1045
Proton	0215, 1185
Quasar	0055
RCA	0205, 0915, 1115
RCA	0205, 0225, 0235, 0325, 0555, 0845
Realistic	1175
Revox	0215
Rotel	0215
Saba Telecommander (E)	0505
SAE	0215
Samsung	1285
Sansui	0215, 0625, 0975, 1025, 1105
Sanyo	0145, 0555, 0635, 0765
Scott	0325, 1105
Sears	0345
Sharp	0235, 0665, 0895, 1065, 1075
Sherwood	0115, 0235, 0395, 0475
Siemens Garrard	1245
Signature	0175
Sontec	1165
Sony	0065, 0565, 0865, 1145
Staron	1235
STS	0025
Sylvania	0215
Symphonic	0335
Tandy	0305
Tangberg	1195
Teac	0235, 0335, 0385, 0525, 0795, 0835, 1355
Technics	0055, 0605, 1095
Techwood	1325
Telefunken (E)	0505
Thomson (E)	0505
Toshiba	0035, 0685
Vector Research	0065, 1135
Wards	0175
Yamaha	0005, 0015, 0085, 0415, 0545, 0575, 1065

CD-RECORDER/CD-RW

Hitachi	0474
JVC (Victor)	0504
Marantz	0484, 0494
Philips	0444
Pioneer	0454, 0464
Yamaha	0414

MD RECORDER

Pioneer	0424
Sharp	0434
Yamaha	0024, 0394, 0404

TAPE DECK

Aiwa	0094, 0214, 0224
Akai	0184
Carver	0094
Denon	0304
Fisher	0144
Garrard	0194, 0204
JVC (Victor)	0274, 0284, 0294
Kenwood	0124, 0134, 0154, 0234, 0244, 0264
Magnavox	0094
Marantz	0094, 0344
Mitsubishi	0184
Onkyo	0364, 0374
Optimus	0034, 0064, 0204, 0334
Philips	0094
Pioneer	0034, 0044, 0064
Revox	0354
Sansui	0094, 0344
Sharp	0264
Sherwood	0334
Sony	0054, 0084, 0324
Teac	0194, 0254
Technics	0074, 0314
Wards	0034
Yamaha	0004, 0014, 0104, 0114, 0164, 0174, 0264

DVD PLAYER

Akai	0108
Denon	0368
Hitachi	0388
JVC (Victor)	0168, 0348
Kenwood	0288
Magnavox	0248
Mitsubishi	0268
Onkyo	0128, 0248
Panasonic	0048
Philips	0188, 0248
Pioneer	0208, 0228
Proscan	0308



YAMAHA ELECTRONICS CORPORATION, USA 6660 ORANGETHORPE AVE., BUENA PARK, CALIF. 90620, U.S.A.
YAMAHA CANADA MUSIC LTD. 135 MILNER AVE., SCARBOROUGH, ONTARIO M1S 3R1, CANADA
YAMAHA ELECTRONIK EUROPA G.m.b.H. SIEMENSSTR. 22-34, 25462 RELLINGEN BEI HAMBURG, F.R. OF GERMANY
YAMAHA ELECTRONIQUE FRANCE S.A. RUE AMBROISE CROIZAT BP70 CROISSY-BEAUBOURG 77312 MARNE-LA-VALLÉE CEDEX02, FRANCE
YAMAHA ELECTRONICS (UK) LTD. YAMAHA HOUSE, 200 RICKMANSWORTH ROAD WATFORD, HERTS WD1 7JS, ENGLAND
YAMAHA SCANDINAVIA A.B. J A WETTERGRENS GATA 1, BOX 30053, 400 43 VÄSTRA FRÖLUNDA, SWEDEN
YAMAHA MUSIC AUSTRALIA PTY, LTD. 17-33 MARKET ST., SOUTH MELBOURNE, 3205 VIC., AUSTRALIA

YAMAHA CORPORATION
Printed in Malaysia ID V723100-2

Connection Guide (when listening to a digital 5.1-channel source)

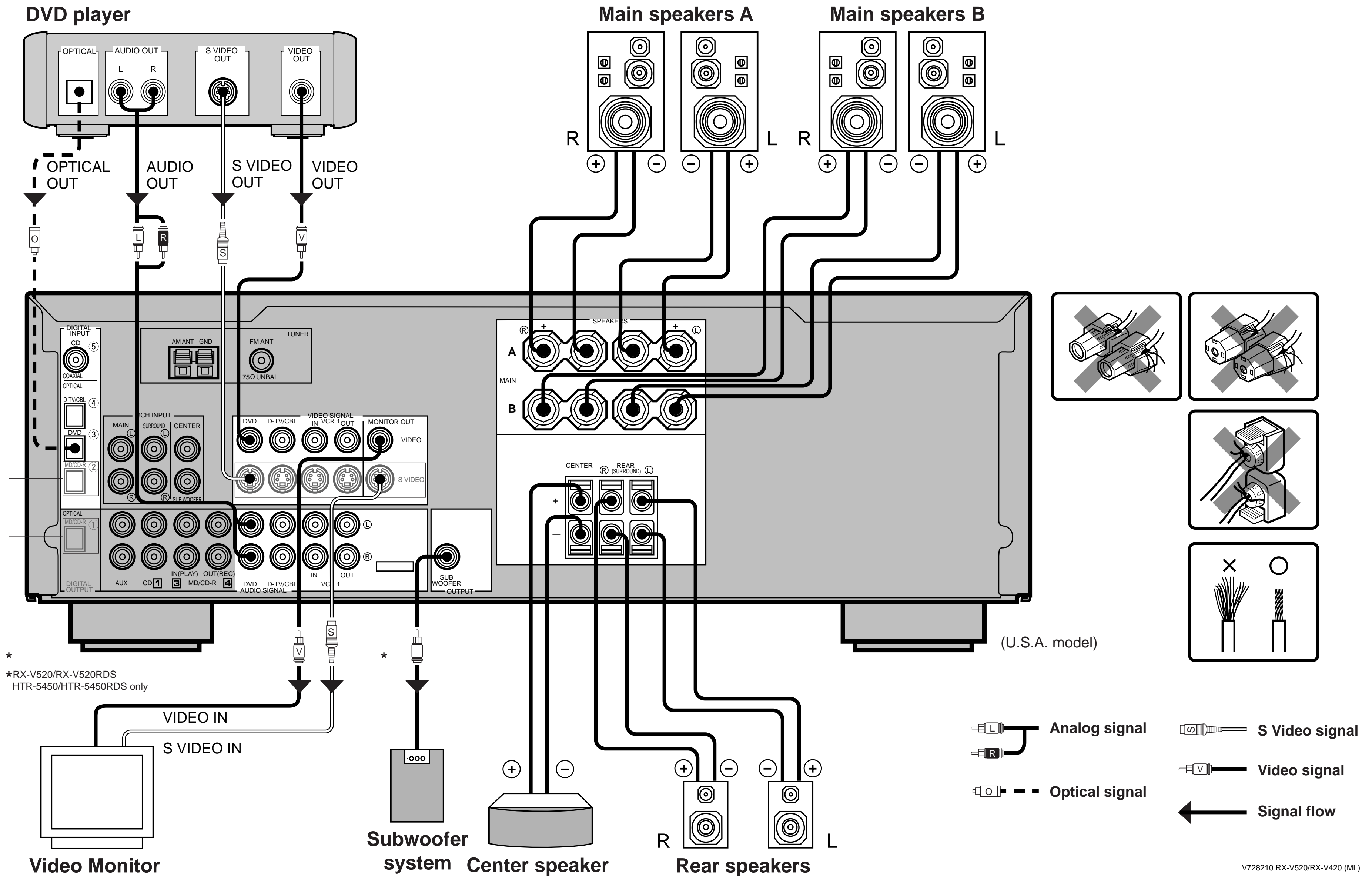

*RX-V520/RX-V520RDS
HTR-5450/HTR-5450RDS only

Quick Reference Card

AMP(TUNER)

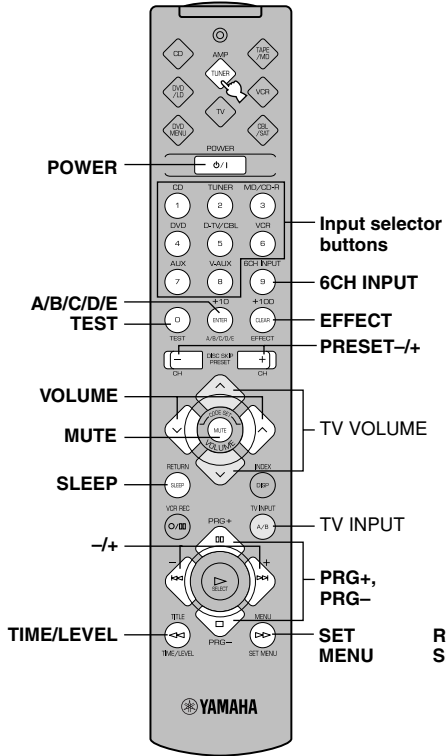

TAPE/MD

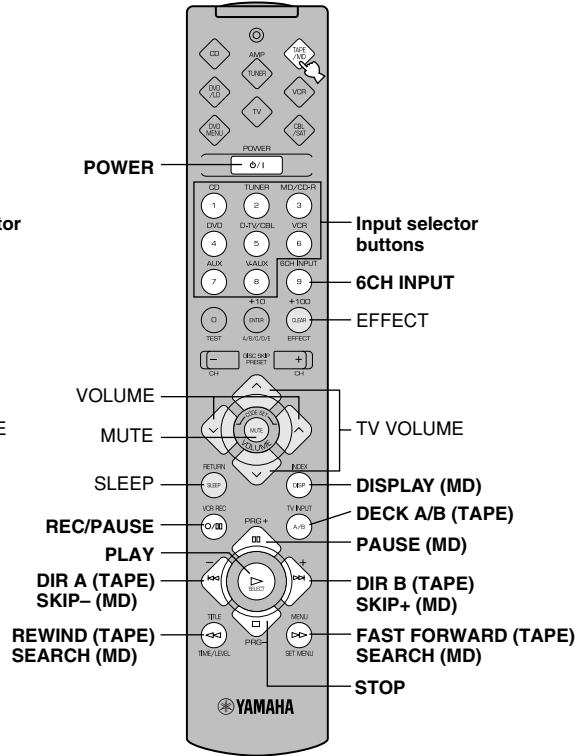

CD

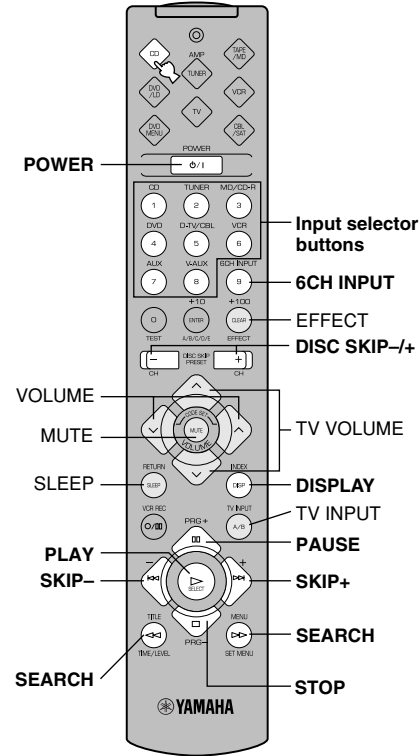

DVD/LD

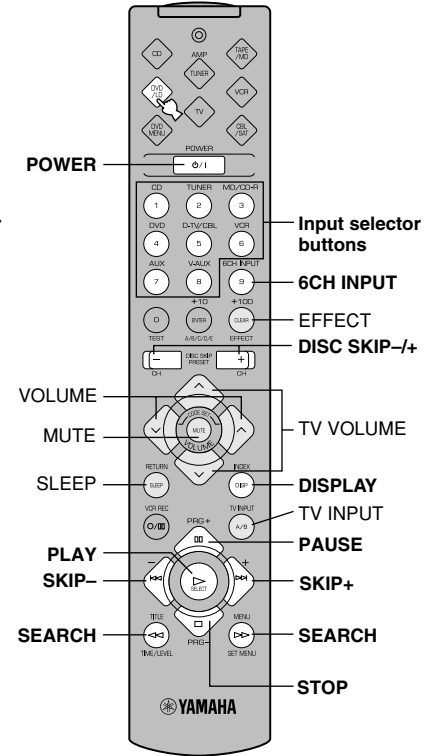

Quick Reference Card

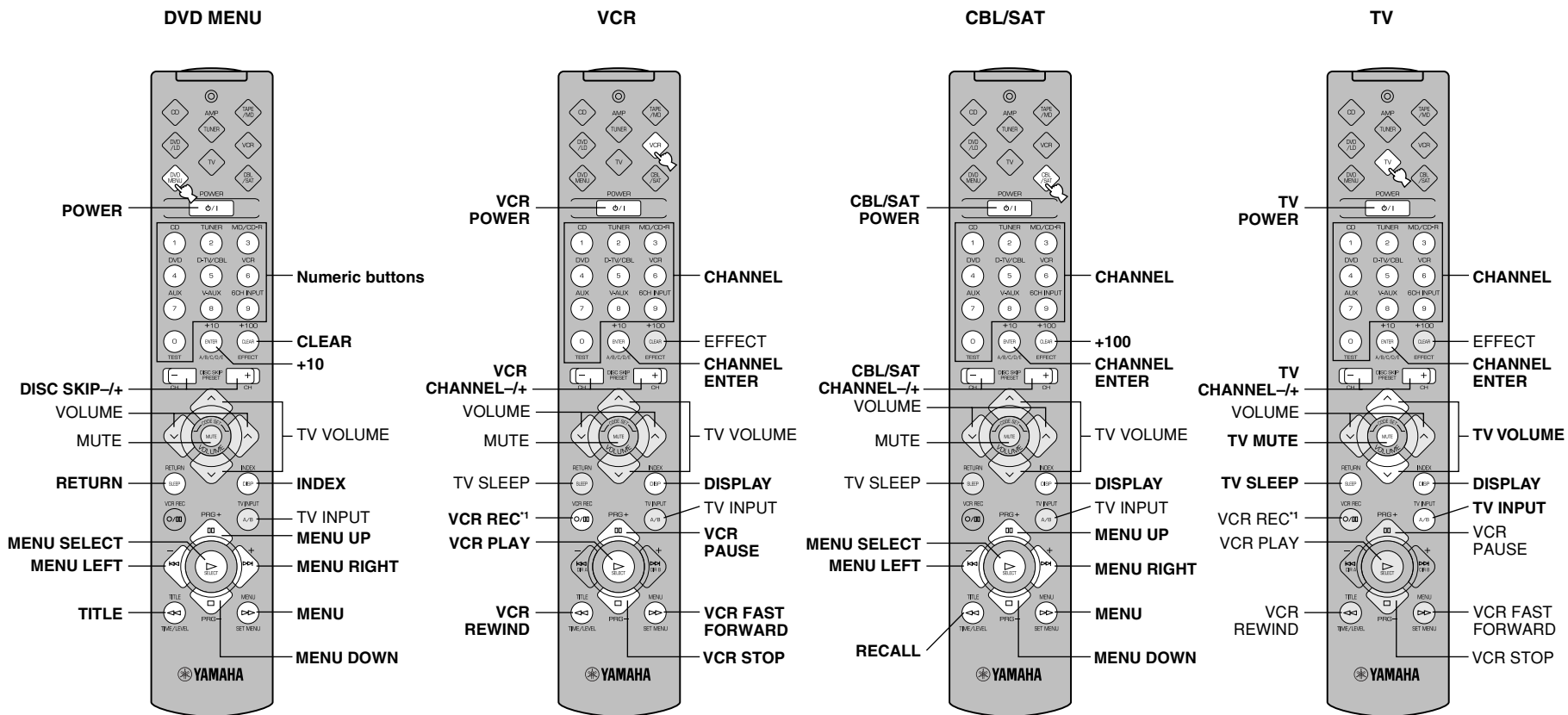

*1 Press this button twice to start recording.
 Appuyer deux fois sur cette touche pour commencer l'enregistrement.
 Drücken Sie diese Taste zweimal, um die Aufnahme zu starten.
 Tryck två gånger på den här knappen för att börja spela in.

Premere due volte questo tasto per iniziare la registrazione.
 Presione dos veces este botón para empezar a grabar.
 Druk tweemaal op deze toets om met opnemen te beginnen.
 按此按钮两次即可开始录像。