

# YAMAHA TX-950 *RS*

*Natural Sound AM/FM Stereo Tuner*  
*40 Station Random Access Preset Tuning*  
*Multi-Status Station Memory*  
*Preset Station Name Storing Capability*  
*Digital Fine Tuning*  
*Rotary Encoder Tuning with Tuning Lock*  
*Computer Servo Lock (CSL) System*  
*2-Position IF Mode Select Buttons*  
*2 FM Outdoor Antenna Installation Capability*  
*BLEND Button*  
*RF ATT (Attenuator) On/Off Button*  
*Remote Control Capability (Optional)*

Thank you for selecting this YAMAHA stereo tuner.

CENTER



## OWNER'S MANUAL

### CONTENTS

|   |    |
|---|----|
| Safety Instructions .....                               | 2  |
| Warning .....   | 3  |
| Supplied Accessories .....                              | 3  |
| Connections .....                                       | 4  |
| Tuning Operations .....                                 | 7  |
| Preset Tuning .....                                     | 11 |
| Remote Control Transmitter<br>(separate purchase) ..... | 13 |
| Troubleshooting .....                                   | 14 |
| Specifications .....                                    | 14 |

### IMPORTANT!

Please make a note of the serial number of this unit in the space indicated below.

Model:  
Serial No.:

The serial number is inscribed on the rear of the unit.  
Keep this Owner's Manual in a safe place for future reference.

### WARNING

To reduce the risk of fire or electric shock, do not expose this appliance to rain or moisture.



### • Explanation of Graphical Symbols



The lightning flash with arrowhead symbol, within an equilateral triangle, is intended to alert you to the presence of unshielded "dangerous voltage" within the product's enclosure that may be of sufficient magnitude to constitute a risk of electric shock to persons.



The exclamation point within an equilateral triangle is intended to alert you to the presence of important operating and maintenance (servicing) instructions in the literature accompanying the appliance.

# SAFETY INSTRUCTIONS

- 1 Read Instructions – All the safety and operating instructions should be read before the unit is operated.
- 2 Retain Instructions – The safety and operating instructions should be retained for future reference.
- 3 Heed Warnings – All warnings on the unit and in the operating instructions should be adhered to.
- 4 Follow Instructions – All operating and other instructions should be followed.
- 5 Water and Moisture – The unit should not be used near water – for example, near a bathtub, washbowl, kitchen sink, laundry tub, in a wet basement, or near a swimming pool, etc.
- 6 Carts and Stands – The unit should be used only with a cart or stand that is recommended by the manufacturer.

6A A unit and cart combination should be moved with care. Quick stops, excessive force, and uneven surfaces may cause the unit and cart combination to overturn.



- 7 Wall or Ceiling Mounting – The unit should be mounted to a wall or ceiling only as recommended by the manufacturer.
- 8 Ventilation – The unit should be situated so that its location or position does not interfere with its proper ventilation. For example, the unit should not be situated on a bed, sofa, rug, or similar surface, that may block the ventilation openings; or placed in a built-in installation, such as a bookcase or cabinet that may impede the flow of air through the ventilation openings.
- 9 Heat – The unit should be situated away from heat sources such as radiators, stoves, or other units that produce heat.
- 10 Power Sources – The unit should be connected to a power supply only of the type described in the operating instructions or as marked on the unit.
- 11 Power-Cord Protection – Power-supply cords should be routed so that they are not likely to be walked on or pinched by items placed upon or against them, paying particular attention to cords at plugs, convenience receptacles, and the point where they exit from the unit.
- 12 Cleaning – The unit should be cleaned only as recommended by the manufacturer.
- 13 Nonuse Periods – The power cord of the unit should be unplugged from the outlet when left unused for a long period of time.
- 14 Object and Liquid Entry – Care should be taken so that objects do not fall into and liquids are not spilled into the inside of the unit.
- 15 Damage Requiring Service – The unit should be serviced by qualified service personnel when:
  - A. The power-supply cord or the plug has been damaged; or
  - B. Objects have fallen, or liquid has been spilled into the unit; or
  - C. The unit has been exposed to rain; or
  - D. The unit does not appear to operate normally or exhibits a marked change in performance; or
  - E. The unit has been dropped, or the cabinet damaged.
- 16 Servicing – The user should not attempt to service the unit beyond those means described in the operating instructions. All other servicing should be referred to qualified service personnel.

- 17 Power Lines – An outdoor antenna should be located away from power lines.
- 18 Grounding or Polarization – Precautions should be taken so that the grounding or polarization is not defeated.
- 19 Outdoor Antenna Grounding – If an outside antenna is connected to this unit, be sure the antenna system is grounded so as to provide some protection against voltage surges and built up static charges. Section 810 of the National Electrical Code, ANSI/NFPA No. 70-1984, provides information with respect to proper grounding of the mast and supporting structure, grounding of the lead-in wire to an antenna discharge unit, size of grounding conductors, location of antenna discharge unit, connection to grounding electrodes, and requirements for the grounding electrode.

EXAMPLE OF ANTENNA GROUNDING

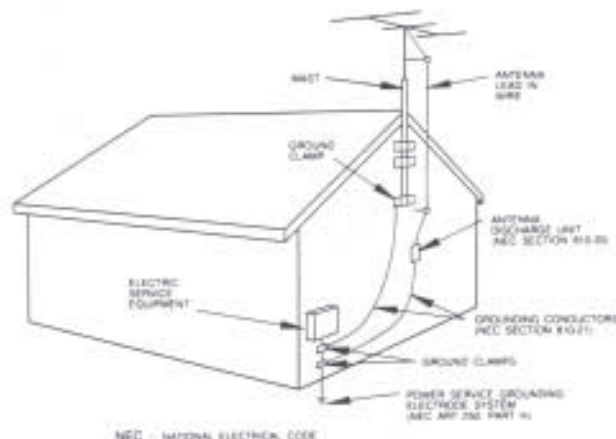

NEC - NATIONAL ELECTRICAL CODE

### Note to CATV system installer:

This reminder is provided to call the CATV system installer's attention to Article 820-40 of the NEC that provides guidelines for proper grounding and, in particular, specifies that the cable ground shall be connected to the grounding system of the building, as close to the point of cable entry as practical.

### CAUTION: READ THIS BEFORE OPERATING YOUR UNIT

- 1 This unit is a sophisticated AM/FM stereo tuner. To ensure proper operation for the best possible performance, please read this manual carefully.
- 2 Choose the installation location of this unit carefully. Avoid placing it in direct sunlight or close to a source of heat. Also avoid locations subject to vibration and excessive dust, heat, cold or moisture. Keep it away from such sources of hum as transformers or motors.
- 3 Do not open the cabinet as this might result in damage to the set, or electrical shock. If a foreign object should get into the set, contact your dealer.
- 4 To prevent lightning damage, pull out the power cord and remove the antenna cable during an electrical storm.
- 5 When removing the power plug from the wall outlet, always pull directly on the plug; never pull the cord itself.
- 6 Do not use force when using the switches.

- 7 When moving the set be sure to first pull out the power plug and remove cords connected to other equipment.
- 8 Do not attempt to clean this unit with chemical solvent as this might damage the finish. Use a clean, dry cloth.
- 9 Be sure to read the "Troubleshooting" section for advice on common operating errors before concluding that this unit is faulty.
- 10 Keep this manual in a safe place for future reference.

### FCC INFORMATION (U.S.A.)

#### 1. IMPORTANT NOTICE : DO NOT MODIFY THIS UNIT!

This product, when installed as indicated in the instructions contained in this manual, meets FCC requirements. Modifications not expressly approved by Yamaha may void your authority, granted by the FCC, to use the product.

2. **IMPORTANT :** When connecting this product to accessories and/or another product use only high quality shielded cables. Cable/s supplied with this product **MUST** be used. Follow all installation instructions. Failure to follow instructions could void your FCC authorization to use this product in the USA.

3. **NOTE :** This product has been tested and found to comply with the requirements listed in FCC Regulations, Part 15 for Class "B" digital devices. Compliance with these requirements provides a reasonable level of assurance that your use of this product in a residential environment will not result in harmful interference with other electronic devices. This equipment generates/uses radio frequencies and, if not installed and used according to the instructions found in the users manual, may cause interference harmful to the operation of other electronic devices.

Compliance with FCC regulations does not guarantee that interference will not occur in all installations. If this product is found to be the source of interference, which can be determined by turning the unit "OFF" and "ON", please try to eliminate the problem by using one of the following measures:

Relocate either this product or the device that is being affected by the interference.

Utilize power outlets that are on different branch (circuit breaker or fuse) circuits or install AC line filter/s.

In the case of radio or TV interference, relocate/reorient the antenna. If the antenna lead-in is 300 ohm ribbon lead, change the lead-in to co-axial type cable.

If these corrective measures do not produce satisfactory results, please contact the local retailer authorized to distribute this type of product. If you can not locate the appropriate retailer, please contact Yamaha Electronics Corp., U.S.A. 6722 Orangethorpe Ave, Buena Park, CA 90620.

The above statements apply **ONLY** to those products distributed by Yamaha Corporation of America or its subsidiaries.

## WARNING: CHEMICAL CONTENT NOTICE!

The solder used in the manufacture of this product contains LEAD. In addition, the electrical/electronic and/or plastic (where applicable) components may also contain traces of chemicals found by the California Health and Welfare Agency (and possibly other entities) to cause cancer and/or birth defects or other reproductive harm.

#### DO NOT REMOVE ANY ENCLOSURE COMPONENTS!

There are no user serviceable parts inside. All service

should be performed by a service representative authorized by Yamaha to perform such service.

**IMPORTANT MESSAGE:** Yamaha strives to produce products that are both user safe and environmentally "friendly". We sincerely believe that our products meet these goals. However, in keeping with both the spirit and the letter of various statutes we have included the preceding messages and others in various locations in this manual.

## SUPPLIED ACCESSORIES

After unpacking, check that the following parts are contained.

AM Loop Antenna/Indoor FM Antenna

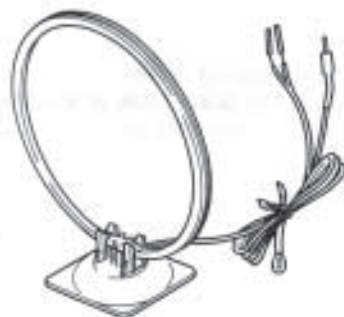

75-ohm/300-ohm Antenna Adapter

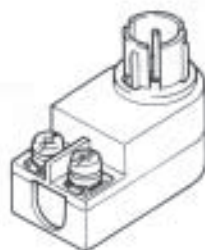

Audio connection cord



# CONNECTIONS

## ANTENNA CONNECTIONS

- Each antenna should be connected to the designated terminals correctly, referring to the following figure.
- Both AM and FM indoor antennas are included with this unit. In general, these antennas will probably provide sufficient signal strength. Nevertheless, a properly installed outdoor antenna will give clearer reception than an indoor one. If you experience poor reception quality, an outdoor antenna may result in improvement.

### U.S.A., CANADA AND GENERAL MODELS

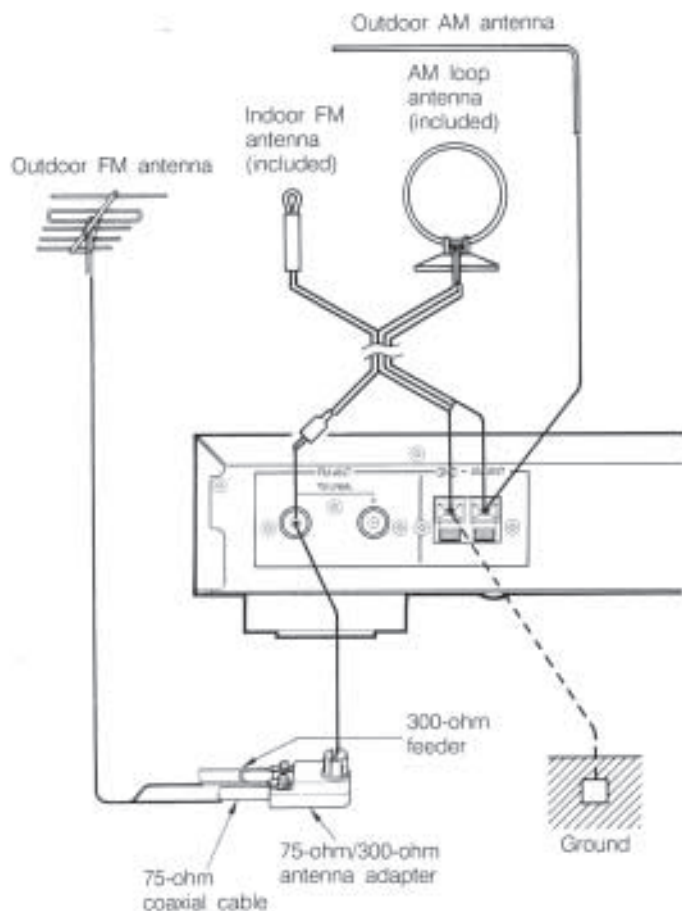

### AUSTRALIA, U.K. AND EUROPE MODELS

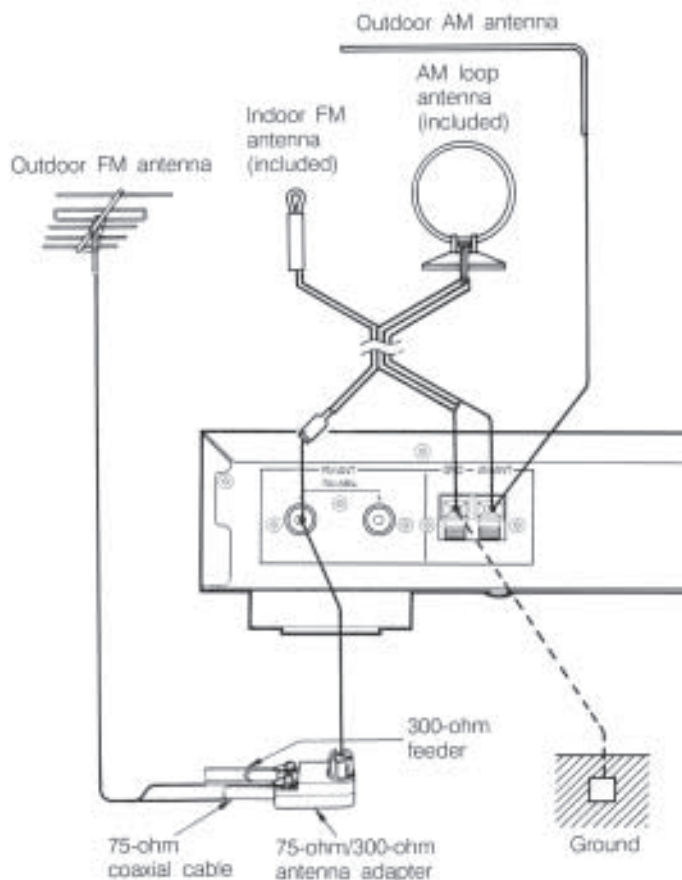

### Using two FM outdoor antennas

Because this unit is equipped with A and B antenna terminals, two FM outdoor antennas, oriented in different directions, can be connected, and you can easily select either the A or B antenna with the **ANTENNA A/B** button on the front panel, so this method of antenna installation is a good way to receive high-quality signals in an area where broadcast transmitting stations exist in different directions. Install one antenna at least 2 meters above (or below) the other and orient each antenna in the direction of a different broadcast transmitting station.



- \* If you connect only one antenna, connect it to the A terminal, and always set the **ANTENNA A/B** button so that "ANT A" illuminates on the display.

### Connecting the indoor FM antenna

(U.S.A., Canada and General models)

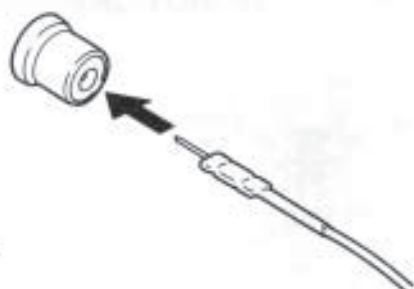

(Australia, U.K. and Europe models)



\* If you connect an outdoor FM antenna to this unit, do not connect the indoor FM antenna to this unit.

### Connecting the AM loop antenna

1

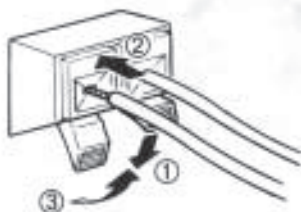

2



3



Orient so that the best reception is obtained.

\* The antenna may be hung on a wall.

\* The AM loop antenna should be kept connected, even if an outdoor AM antenna is connected to this unit.

### Positioning of the AM loop antenna/indoor FM antenna

After the connections, place the indoor FM antenna to the position where the best reception is obtained, and next, orient the AM loop antenna so that the best reception is obtained. However, if the orientation of the AM loop antenna moves the pre-positioned indoor FM antenna, you can separate the antennas with your hands easily and place each antenna to the best position.

### Optional outdoor FM antenna

Consult with your dealer or authorized service center about the best method of selecting and erecting an outdoor FM antenna.

The choice of the feeder cable is also important. Flat ribbon-shaped twin-lead cable performs well electrically, and is cheaper and somewhat easier to handle when routing it through windows and around rooms. Coaxial cable is more expensive, does a much better job of minimizing interference, is less prone to the effects of weather and close-by metal objects, and is nearly as good a signal conductor as feeder cable, particularly for foam-type coaxial cables. Coaxial cable is somewhat more difficult to install at the point where the cable enters the building. If coaxial cable is selected, make sure the antenna is designed to be used with that type of cable.

\* Use the included 300-ohm/75-ohm antenna adapter for connecting the outdoor FM antenna to this unit.

300-ohm feeder cable

75-ohm coaxial cable



75-ohm/300-ohm antenna adapter

### Notes for FM antenna installation

- To minimize automobile ignition noise, locate the antenna as far from heavy traffic as possible.
- Keep the feeder cable or coaxial cable as short as possible. Do not bundle or roll up excess cable.
- The antenna should be at least two meters (6.6 feet) from reinforced concrete walls or metal structures.



300-ohm feeder cable



75-ohm coaxial cable

### Connecting coaxial cable to the included 75-ohm/300-ohm antenna adapter

1. Open the cover of the included 75-ohm/300-ohm antenna adapter.

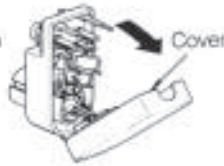

2. Cut the end of the 75-ohm coaxial cable and prepare it as shown below.

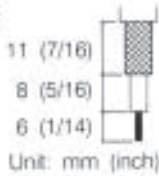

3. Cut the red lead wire and remove it.

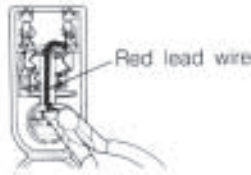

4. Insert the cable wire into the slot as shown below, and clamp it with pliers.

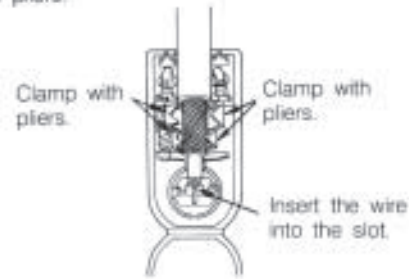

5. Snap the cover into place.

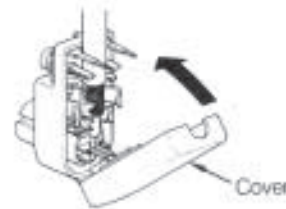

### Optional outdoor AM antenna

In steel buildings or at a great distance from the transmitter, it may be necessary to install an outside long wire antenna.

#### GND terminal

For maximum safety and minimum interference, connect the **GND** terminal to a good earth ground. A good earth ground is a metal stake driven into moist earth.

## CONNECTIONS TO THE AMPLIFIER

- Before making any connections, switch OFF the power to this unit and the amplifier or other component.

- Be sure that the connections from the left ("L") and right ("R") OUTPUT terminals are connected to the corresponding (left and right) input terminals of the amplifier or other component.

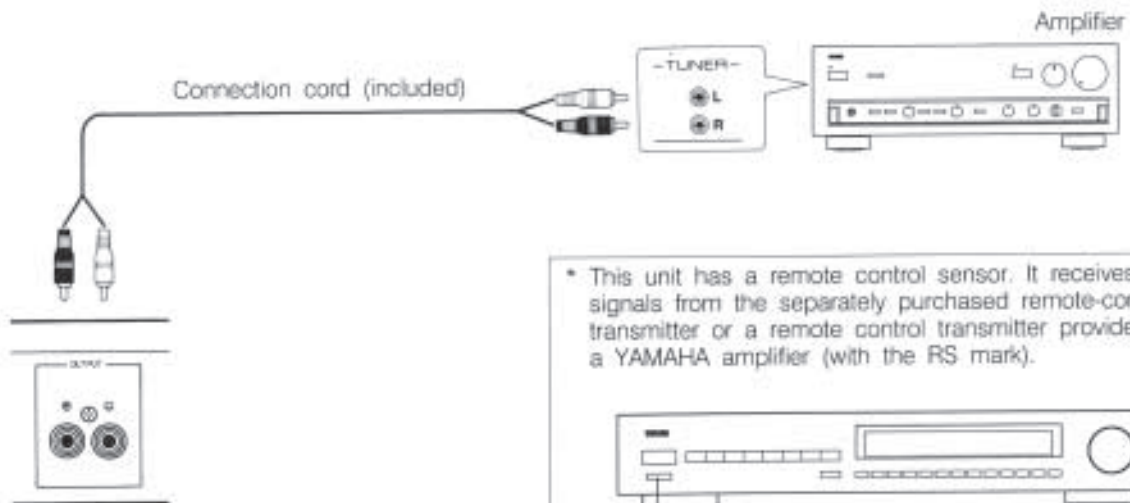

- \* This unit has a remote control sensor. It receives signals from the separately purchased remote-control transmitter or a remote control transmitter provided with a YAMAHA amplifier (with the RS mark).

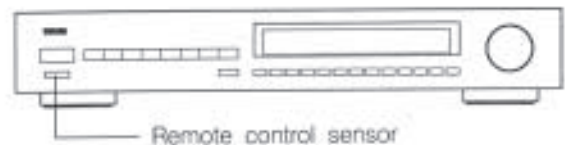



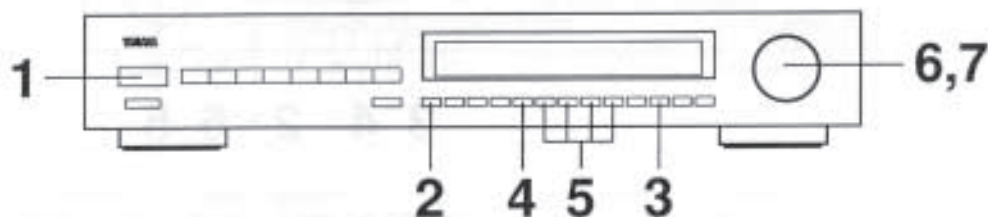

# TUNING OPERATIONS

Normally, if station signals are strong and there is no interference, quick automatic-search tuning (AUTOMATIC TUNING) is possible. However, if signals of the station you want to select are weak, you must tune to it manually (MANUAL TUNING).



## AUTOMATIC TUNING

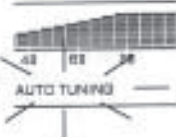

**1**  POWER

**2** Select the reception band (FM or AM) while watching the display.  
 FM/AM →  or 

**3**  TUNING MODE →  AUTO TUNING

**4**  MODE →  89.00

**5** For FM reception, set the **BLEND**, **IF MODE** and **RF ATT** buttons as desired. (Refer to page 9 for details.)

**6** Tune to a desired station.



To tune to a higher frequency, slightly turn the control to the right. To tune to a lower frequency, slightly turn the control to the left.

**7** If the station where tuning search stopped is not the desired one, follow step 6 again.



\* If the tuning search does not stop at the desired station, change to the MANUAL TUNING method as described on the following page.

### Note

Be sure to set the **LOCK** button so that "LOCK" does not illuminate on the display. Otherwise, the **TUNING** control will not function. (Refer to page 10 for details.)

### Display information

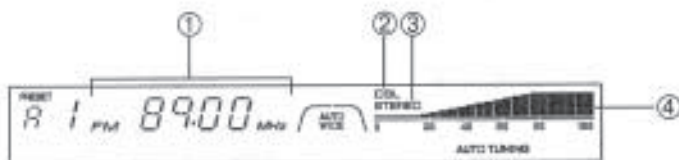

- ① Displays the band and frequency of the received station.
- ② Illuminates when the Computer Servo Lock (CSL) system is activated during the FM reception mode. (See page 10.)
- ③ Illuminates when an FM stereo broadcast with sufficient signal strength is received.
- ④ Indicates the signal level of the received station.

## MANUAL TUNING

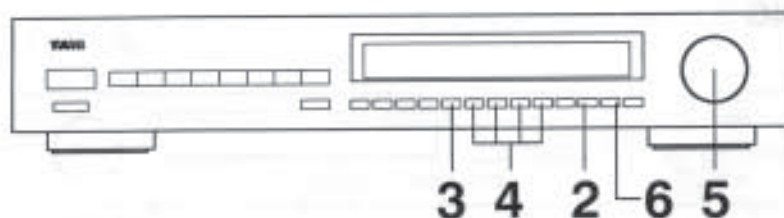

**1** Follow step 1 and 2 on the previous page.

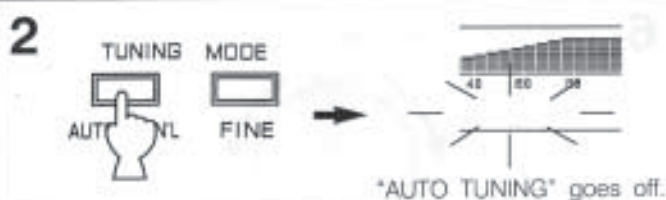

**3** When receiving a weak FM broadcast, you can obtain higher signal quality by receiving it in monaural.



**4** For FM reception, set the **BLEND, IF MODE** and **RF ATT** buttons as desired. (Refer to page 9 for details.)

**5** Tune to a desired station manually.



**6** If you desire more precise tuning, use the FINE TUNING method described below.

### Note

Be sure to set the **LOCK** button so that "LOCK" does not illuminate on the display. Otherwise, the **TUNING** control will not function. (Refer to page 10 for details.)

## FINE TUNING

Rapid tuning is usually possible with the automatic or manual tuning method, but more precise tuning is possible by fine tuning under the following conditions:

- To receive a weak or very badly fading broadcast signal from among many signals
- To receive a weak or medium-strength signal which is near a strong signal
- If "beat" noise is received

Under these conditions, manual tuning and then fine tuning can be used to reduce noise and distortion.



- \* When this button is pressed, the displayed frequency changes by 0.01 MHz for FM, and 1 kHz for the AM band.



## Other functions to improve reception signal quality

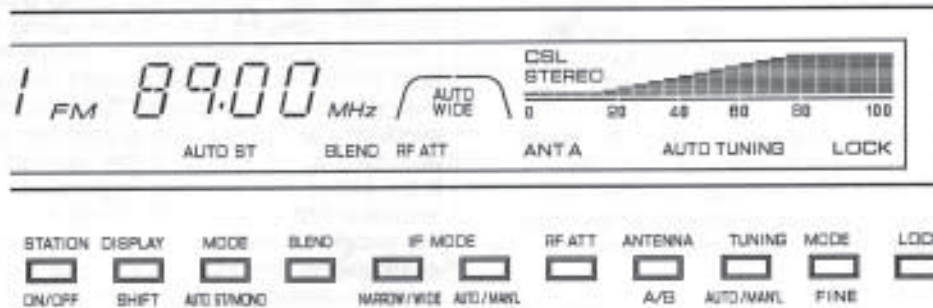

### IF MODE buttons

These buttons are used to vary the bandpass of the FM intermediate frequency (IF) between WIDE and NARROW.

#### AUTO/MAN'L:

This button is used to select the automatic or manual IF tuning mode. When the automatic IF tuning mode is selected, the "AUTO" indicator illuminates and the tuner automatically selects the IF bandpass width (WIDE or NARROW).

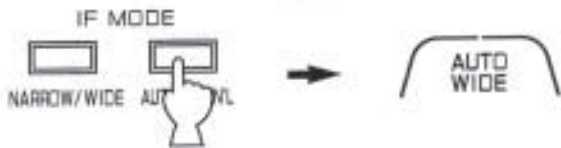

To select the IF bandpass width yourself (manual IF tuning mode), press this button so that the "AUTO" indicator switches off, and then select the IF bandpass width by pressing the **NARROW/WIDE** button.



#### NARROW/WIDE:

Press this button to select the IF bandpass width in the manual IF tuning mode. Before pressing this button, be sure to press the **AUTO/MAN'L** button so that the "AUTO" indicator switches off.

If the reception signal is strong, press this button so that the "WIDE" indicator illuminates (to obtain distortion-free sound). When the reception signal is weak, or when the desired station is interfered with by adjacent stations, press this button so that the "NARROW" indicator illuminates (to increase the selectivity).



### BLEND button

If this button is set so that the "BLEND" indicator illuminates, and the signal-to-noise ratio of a stereo signal is less than about 50 dB, the left and right channels are blended accordingly to make the reception signal quality higher. When the **MODE AUTO ST/MONO** button is set to the monaural mode (so that the "AUTO ST" indicator does not illuminate), the BLEND function will not operate even if the BLEND indicator illuminates.



### RF ATT button

This button is used to reduce RF cross-modulation and intermodulation. In addition, it can be used, together with the **IF MODE** button, to improve the reception signal condition.

If the reception signal is strong, press this button so that the "RF ATT" indicator illuminates. In this position, RF cross-modulation and intermodulation will be reduced. To receive a distant FM broadcast, press this button so that the "RF ATT" indicator switches off (to obtain a better signal-to-noise ratio).



## LOCK button

This button is used to lock-in the frequency of the broadcast, so that drift-free FM reception is possible. Press this button so that the LOCK indicator illuminates, and the displayed frequency will be locked-in, even if there are changes in the temperature and/or humidity. This function is particularly useful when making a long FM broadcast recording.

\* The preset stations can be received by using the preset station buttons even if the LOCK indicator illuminates. Press this button so that the LOCK indicator switches off when receiving a weak FM broadcast, especially when there is an adjacent strong station interfering with the desired station.



### Technical notes on the Computer Servo Lock (CSL) system

The Yamaha Computer Servo Lock Tuning system eliminates many conventional tuning problems by effectively providing two different tuning modes, each optimized for different types of reception conditions, and both controlled by a sophisticated microprocessor. The microprocessor discriminates between different reception conditions and selects the appropriate tuning mode according to the quality of the received signal. If the station has a strong, high-quality signal, an infinite-resolution FM stereo tuning circuit is used to lock onto the station for maximum audio quality. For a weak, poor-quality signal, the PLL tuning mode locks onto the station so as to assure the best possible reception.

# PRESET TUNING

This unit can store station frequencies (selected by tuning operation) by using the preset station buttons. With this function, you can select any desired station by only pressing the corresponding preset station button. Up to 40 stations (8 stations per page) can be stored.

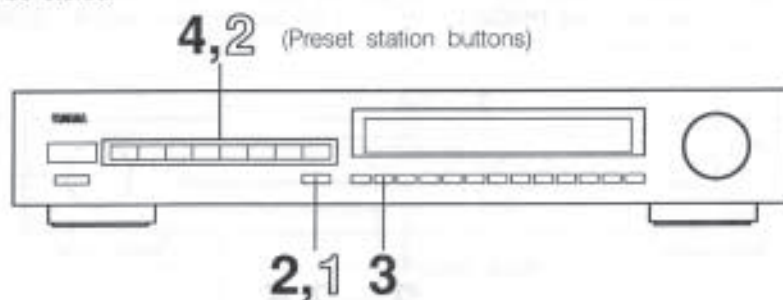

## To store stations

- 1** Tune to a desired station.  
(Refer to pages 7-10 for tuning procedures.)  
\* If desired, change the setting of the **PRESET** switch on the rear panel. (See below.)
- 2** Select a desired page (A - E) of preset station buttons while watching the display.
- 3**

Flashes on and off for about 5 seconds.
- 4** Press a preset station button before "MEMORY" goes off from the display.

Shows the displayed station has been programmed to A1.

  - \* In the same way, program other stations to A2, A3 ... A8.
  - \* You can program more stations to the preset station buttons on other pages in the same way by selecting other pages in step 2.

## To recall a preset station

- 1** Select the page of preset station buttons.
- 2**

Select the desired preset station button.

### About the PRESET switch on the rear panel

Set the **PRESET** switch on the rear panel to a desired position when the power of this unit is off.

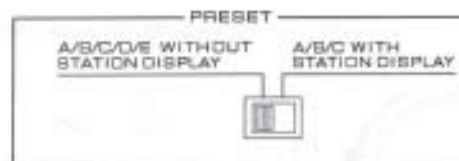

- You can store up to 40 stations using 5 pages (A, B, C, D, E) of the preset station buttons.
- You can store up to 24 stations using 3 pages (A, B, C). Moreover, in this position you can store names for preset stations. (Refer to the following page.)

\* The design of the switch is different for general models.

## Notes

- For FM reception, the settings of the **MODE**, **BLEND**, **IF MODE**, **RF ATT**, **ANTENNA** and **TUNING MODE FINE** buttons (and optionally the station names) are stored along with the station frequency.

- A new setting can be programmed in place of the former one.
- The **PRESET** switch can be switched only when the power of this unit is off.

## To store stations with name

You can preset a station by name instead of by frequency. As many as 4 letters and/or numerals can be selected. By using a station name, you can easily find a certain station even if you are not sure of that station's frequency.

\* However, this function is available only when the **PRESET** switch on the rear panel is set to "A/B/C WITH STATION DISPLAY". (Note that, in this case, the maximum number of stations you can store is 24.)

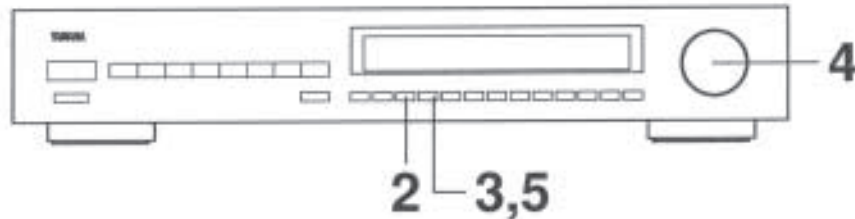

- 1** Tune to a desired station.  
(Refer to pages 7-10 for tuning procedures.)  
\* If desired, change the setting of the **PRESET** switch on the rear panel. (See the previous page.)

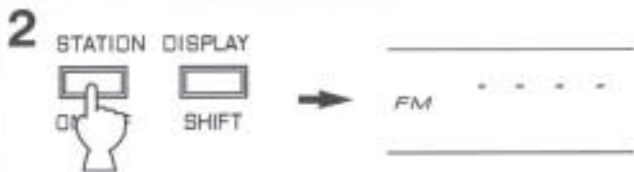

- 4** Select the first letter or numeral to be memorized.



\* By turning **TUNING** control clockwise, the display will indicate "A, B, C --- Z, 1, 2, 3 --- 9, 0, [ ] and - -" in sequence.

- 5** When the desired letter or numeral appears, press the **STATION DISPLAY SHIFT** button to proceed to the selection of the next letter or numeral.

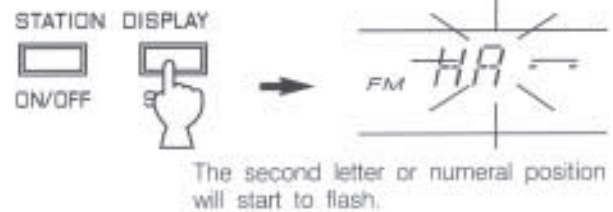

- 6** Repeat steps 4 and 5 for the other letters and/or numerals, if necessary.

- 7** After the naming is finished, follow steps 2-4 of "To store stations" on the previous page.

### Memory back-up

The memory back-up circuit prevents the programmed data from being lost even if the **POWER** switch is set off or the power plug is disconnected from the AC outlet or the power is cut due to temporary power failure. If, however, the power is cut for more than one week, the memory may be erased. If so, it can be re-programmed by simply following the **PRESET TUNING** steps.

# REMOTE CONTROL TRANSMITTER

(separate purchase)

## Functions

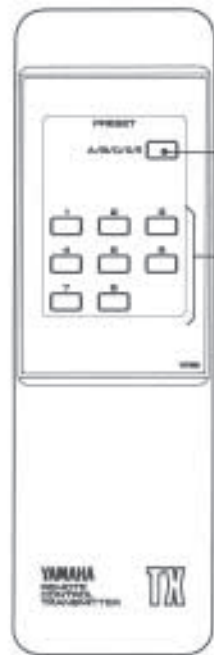

### A/B/C/D/E

Selects a desired page (A-E) of the preset station buttons (for the PRESET TUNING on page 11).

### Preset station buttons

Used to store stations or recall stored stations (for the PRESET TUNING on page 11).

## Battery installation

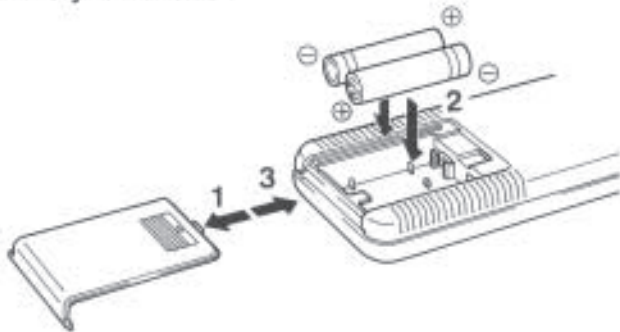

## Battery replacement

If the remote-control transmitter must be used closer to the main unit, the batteries are weak. Replace both batteries with new ones.

### Notes:

- Use only "AA" (R6) batteries for replacement.
- Be sure the polarities are correct. (See the illustration inside the battery compartment.)
- Remove the batteries if the remote-control transmitter will not be used for an extended period of time.
- If batteries leak, immediately dispose of them. Avoid touching the leaked material or letting it come in contact with clothing, etc. Clean the battery compartment thoroughly before installing new batteries.

## Remote-control transmitter operation range

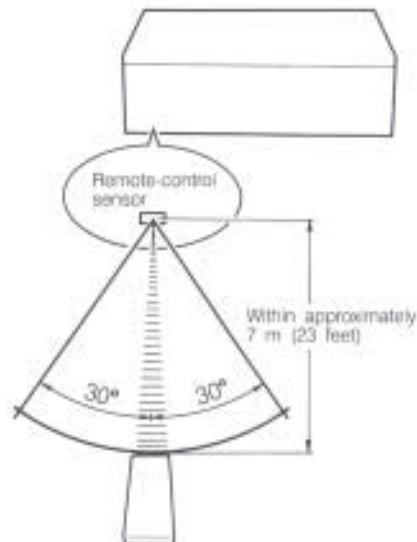

### Notes

- There should be no large obstacles between the remote-control transmitter and the main unit.
- If the remote control sensor is directly illuminated by strong lighting (or an inverter type of fluorescent lamp etc.), it may happen that the remote-control transmitter does not work correctly. In this case, change the position of the main unit to avoid being lit directly.

# TROUBLESHOOTING

If the unit fails to operate normally, check the following points to determine whether the fault can be corrected by the simple measures suggested. If it cannot be corrected, or if the fault is not listed in the SYMPTOM column, disconnect the power cord and contact your authorized YAMAHA dealer or service center for help.

|   | SYMPTOM  | CAUSE  | REMEDY  |
|---|--|--|---|
| FM  | Crackling sounds from time to time (especially in weak signal areas).  | Ignition noise from passing vehicles.  | The FM antenna should be put up as high as possible, away from the road, and a coaxial cable used.                            |
|   |  | Noise from thermostats or other electrical equipment.  | Attach a noise suppressor to the equipment causing the noise.   |
|   | FM stereo reception is noisy.  | Because of the characteristics of FM stereo broadcasts, this is limited to cases where the transmitter is far away or the antenna input is poor. | Check the antenna connections. Try using a multiple element FM antenna. Set the TUNING MODE button to the manual tuning mode. |
|   | The STEREO indicator flickers and reception is noisy.  | Insufficient antenna input.  | Use an antenna appropriate for the reception condition in your area.  |
|   |  | Not tuned correctly.   | Tune again.   |
|   | There is distortion and clear reception cannot be obtained even with a good FM antenna.  | There is multi-path interference.  | Adjust antenna placement to eliminate multi-path interference.  |
|   | No stereo effect even with a stereo broadcast.   | The TUNING MODE button is set to the manual tuning mode.   | Set the button properly.  |
| AM  | A desired station cannot be tuned in with Automatic tuning.  | The station is too weak.   | Use the manual tuning mode. Set the IF MODE NARROW/WIDE button correctly. Use a high quality directional FM antenna.          |
|   | Previously preset stations can no longer be tuned in.  | The tuner has been unplugged for a long period.  | Repeat the presetting procedure.  |
|   | Insufficient sensitivity.  | Weak signal or loose antenna connections.  | Tighten the AM loop antenna connections and rotate it for best reception.   |
|   |  |  | Use the manual tuning mode.   |
|   | A desired station cannot be tuned in with Automatic tuning.  |  |   |
|   | There are continuous crackling and hissing noises.   | These noises result from lightning, fluorescent lamps, motors, thermostats and other electrical equipment.                                       | Use an outdoor antenna and a ground wire. This will help somewhat but it is difficult to eliminate all noise.                 |
|   | There are buzzing and whining noises (especially in the evening).  | Another station is interfering with the received station.  | This is impossible to remedy.   |
| A television set is being used nearby.        |  | Move the television away.  |   |
| The remote-control transmitter does not work. | Direct sunlight or lighting (of an inverter type of fluorescent lamp etc.) is striking the remote control sensor of the main unit. | Change position of the main unit.  |   |

# SPECIFICATIONS

## FM SECTION

|  |                        |
|--|------------------------|
| Tuning Range   |                        |
| [U.S.A., Canada and General models]                    | 87.5 to 108 MHz        |
| [U.K., Australia, Europe and General models]           | 87.5 to 108 MHz        |
| 50 dB Quieting Sensitivity (IHF) [Except Europe model] |                        |
| 75 ohms Mono   | 1.55 $\mu$ V (15.1 dB) |
| 75 ohms Stereo (NARROW)                                | 21 $\mu$ V (37.7 dB)   |
| Usable Sensitivity                                     |                        |
| [Except Europe model]                                  |                        |
| 75 ohms, 1 kHz, 100% mod. (30 dB S/N Quieting)         | 0.8 $\mu$ V (9.3 dB)   |
| [Europe model] (D/N)                                   |                        |
| 75 ohms Mono (S/N 26 dB)                               | 0.8 $\mu$ V            |
| 75 ohms Stereo (S/N 46 dB)                             | 22 $\mu$ V             |
| Image Response Ratio                                   | 90 dB                  |
| IF Response Ratio                                      | 110 dB                 |
| Spurious Response Ratio                                | 110 dB                 |
| AM Suppression Ratio                                   | 70 dB                  |
| Capture Ratio  | 1.2 dB                 |
| Alternate Channel Selectivity                          |                        |
| [Except Europe model]                                  | 85 dB                  |
| Selectivity (two signals, 40 kHz Dev., = 300 kHz)      |                        |
| [Europe model]   | 70 dB                  |

## Signal-to-Noise Ratio

|                                |                |
|--------------------------------|----------------|
| [Except Europe model] (IHF)    |                |
| Mono                           | 96 dB          |
| Stereo                         | 90 dB          |
| [Europe model] (DIN-NOISE RMS) |                |
| Mono (40 kHz Dev.)             | 84 dB          |
| Stereo (40 kHz Dev.)           | 78 dB          |
| Harmonic Distortion (1 kHz)    |                |
| [Except Europe model]          |                |
| Mono/Stereo                    | 0.02%/0.03%    |
| [Europe model (40 kHz Dev.)]   |                |
| Mono/Stereo                    | 0.02%/0.03%    |
| Stereo Separation              | 1 kHz 60 dB    |
| Frequency Response             |                |
| 20 Hz to 15 kHz                | 0 $\pm$ 0.5 dB |

## AM SECTION

|                                     |                  |
|-------------------------------------|------------------|
| Tuning Range                        |                  |
| [U.S.A., Canada and General models] | 520 to 1,720 kHz |
| [U.K., Australia and Europe models] |                  |
|                                     | 522 to 1,620 kHz |
| Usable Sensitivity                  | 100 $\mu$ V/m    |
| Selectivity                         | 32 dB            |
| Signal-to-Noise Ratio               | 52 dB            |
| Image Response Ratio                | 40 dB            |
| Spurious Response Ratio             | 50 dB            |
| Harmonic Distortion, 400Hz          | 0.3%             |

## AUDIO SECTION

|                        |                 |
|------------------------|-----------------|
| Output Level/Impedance |                 |
| FM (100 % mod. 1 kHz)  |                 |
| [Except Europe model]  | 500 mW/2 k-ohms |
| [Europe model]         | 400 mW/2 k-ohms |
| AM (30% mod. 400 Hz)   | 150 mW/2 k-ohms |

## GENERAL

|                           |  |
|---------------------------|--|
| Power Supply              |  |
| U.S.A. and Canada models  | 120V, 60 Hz  |
| Europe model              | 230V, 50 Hz  |
| U.K. and Australia models | 240V, 50 Hz  |
| General model             | 110-120/220-240V, 50/60 Hz   |
| Power Consumption         | 10W  |
| Dimensions (W x H x D)    | 435 x 76 x 320 mm<br>(17-1/8" x 3" x 12-5/8")  |
| Weight                    | 3.4 kg (7 lbs. 8 oz.)  |
| Accessories               | Audio connection cord<br>75-ohm/300-ohm antenna adapter<br>AM loop antenna/indoor FM antenna |

Specifications subject to change without notice.

# YAMAHA

YAMAHA ELECTRONICS CORPORATION, USA 6722 ORANGETHORPE AVE., BUENA PARK, CALIF. 90621, U.S.A.  
YAMAHA CANADA MUSIC LTD. 135 MILNER AVE., SCARBOROUGH, ONTARIO M1S 3R1, CANADA  
YAMAHA ELECTRONIK EUROPA G.m.b.H. SIEMENSSTR. 23-24, D-2084 RELLINGEN 661 HAMBURG, F.R.G.  
YAMAHA ELECTRONIQUE FRANCE S.A. 17 RUE DES CAMPANELLES, LOGNES 77321 MARNE LA VALLEE CEDEX 2, FRANCE  
YAMAHA ELECTRONICS (UK) LTD. YAMAHA HOUSE, 200 RICKMANSWORTH ROAD, WATFORD, HERTS WD1 7JL, ENGLAND  
YAMAHA SCANDINAVIA A.B. J. A. WETTERGRENNS GATA 1, BOX 30253, 400 43 VASTRA FROLANDA, SWEDEN  
YAMAHA MUSIC AUSTRALIA PTY. LTD. 17-23 MARKET ST., SOUTH MELBOURNE, 3205 VIC., AUSTRALIA

YAMAHA CORPORATION  
VL43450-0 B/WB, b  Printed in Japan.