

Portable Player Dock
PDX-11 Owner's manual English

Supplied Accessories

Please confirm that the following accessories are included before using the unit.
• Remote control • AC adaptor

Features

- **Multi-Source Mix**
When an iPhone/iPod and another external device are connected to PDX-11, audio can be enjoyed in many ways—for example, by playing music while listening to the news.
- **Integrated Volume Control**
You can control the PDX-11's volume level by operating the volume control function on the iPhone/iPod.
- **Charge Your iPhone/iPod Battery**
- **Battery Operation**
You can enjoy listening to music anytime, anywhere.

Before Use

Connect the included AC adaptor.

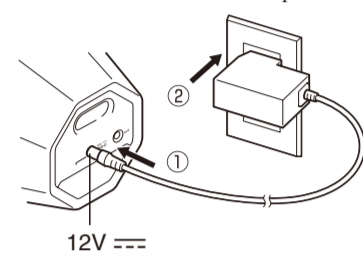

Connect the AC adaptor to PDX-11, before connecting the power cable to the wall outlet.
When using PDX-11 with batteries, disconnect the AC adaptor from the rear panel.

● **When Operating PDX-11 Using Batteries**

Use 6 commercially available AA batteries.

- 1 To remove the battery cover, push the tab while lifting the cover upward.
- 2 Follow the + and - markings on PDX-11 when inserting the batteries.
- 3 Replace the battery cover.

During battery-powered operation, if PDX-11 is left in the powered-off state without being operated for 30 minutes, power-saving mode will be activated and remote control will not work.
Push the **Power on/off** on the control panel of PDX-11 to cancel the power-saving mode.

1 Turning on the Power

Push the **Power on/off**.

When the power is on, the green status indicator will light up.

When PDX-11 is left in the powered-on state without connecting to the iPhone/iPod and external device's connector cable, it will turn off in 30 minutes.

Control Panel

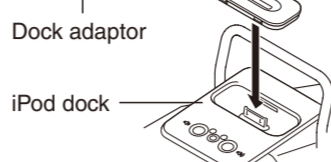
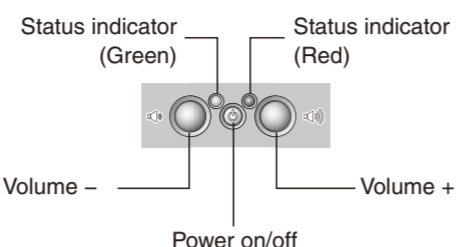

2 Connecting Music Devices

Connect the iPhone/iPod to the iPod dock. The battery of the connected iPhone/iPod will be charged.

Notes

- The iPhone/iPod battery cannot be charged when PDX-11 is being operated by batteries.
- Be sure to use a dock adaptor included your iPhone/iPod or applicable commercially available dock adaptor. If you do not use an adaptor or the adaptor is not compatible, the connection may be loose or poor, causing damage to the connector. For more information about the dock adaptor, refer to Apple's website.
- If the iPhone/iPod is forcibly connected while still in a protective case, the connector may be damaged. Make sure to remove any protective iPhone/iPod case before connecting.
- When the unit is used with the iPhone/iPod's shake shuffle function on, the iPhone/iPod might shuffle due to the vibration of speaker depending on the music played back. If this happens, turn the shake shuffle function off. (Refer to the instruction manual of the iPhone/iPod to turn the function off.)
- Always disconnect iPhone/iPod from PDX-11, before carrying it by its handle.
- If the iPhone/iPod is connected while playing videos or music on the iPhone/iPod, PDX-11 will turn on automatically and continue the play (except when PDX-11 is in power-saving mode).
- You can always connect and disconnect the iPhone/iPod.
- The PDX-11's volume level can be adjusted using the iPhone/iPod. The volume level will also be displayed on the iPhone/iPod.
- PDX-11 turns off automatically, when the iPhone/iPod and external device's connector cable are disconnected.

Connecting an External Device

Connect to the AUX on the rear panel.

To connect an external device to PDX-11, use a commercially available 3.5 mm (1/8 in.) stereo mini plug cable.

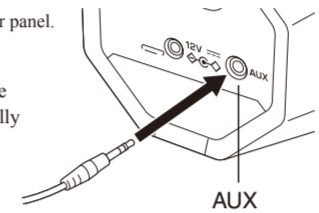

3 Playing Audio

If you start playback on the connected device, sound will come from the PDX-11's speakers. iPhone/iPod's playback can be controlled using either the included remote control or the iPhone/iPod itself.

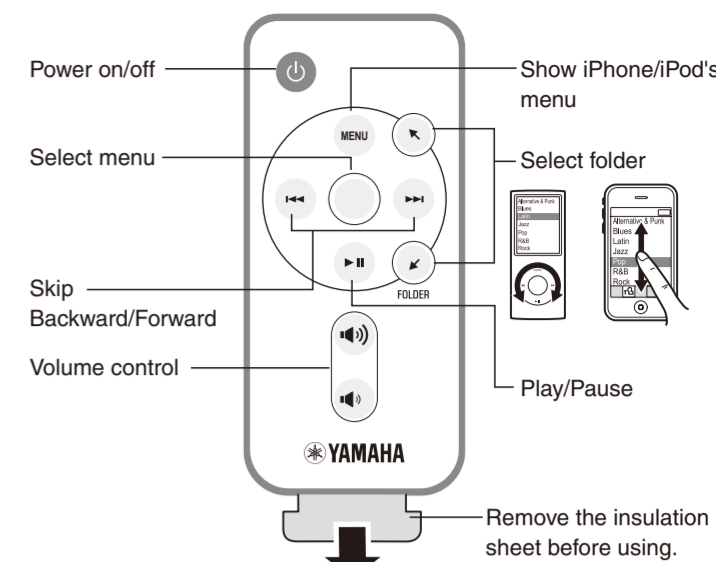

● **Operate by the Remote Control**

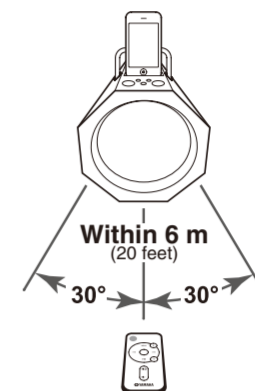

● **Replacing the Battery**

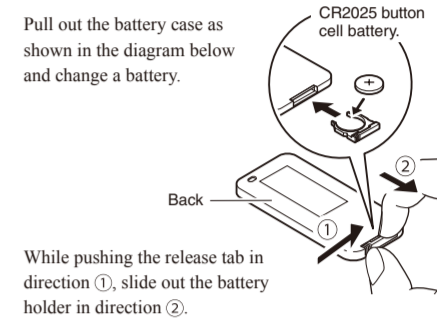

● **Status Indicators (LED)**

Indicate the status of PDX-11 and the connected iPhone/iPod.
Green status indicator:
PDX-11 is turned on and operating normally.
Red status indicator:
An error has occurred or the volume has reached its maximum or minimum level.
The status of external device (connected through AUX) is not indicated.

| LED | | Status |
|------------------|------------------|--|
| Green | Red | |
| ● | ○ | The PDX-11's power is ON. The iPhone/iPod is connected correctly. * If PDX-11 is not operated for 30 seconds, the green status indicator is dimmed. |
| ☀ | ○ | Connection with iPhone/iPod is in progress, please wait. |
| ☀ Blinks once | ○ | An operation has been performed using the PDX-11's controls, the remote control, or the iPhone/iPod itself. |
| ● | ☀ | Refer to the "TROUBLESHOOTING". |
| ● | ☀ Blinks once | The volume is at the maximum or minimum level. |

- ...Green indicator lit
- ☀ ...Green indicator blinking
- ☀ ...Red indicator blinking
- ...Indicator not lit

CAUTION: READ THIS BEFORE OPERATING YOUR UNIT.

- To assure the finest performance, please read this manual carefully. Keep it in a safe place for future reference.
- 1 Install this unit in a well ventilated, cool, dry, clean place - away from direct sunlight, heat sources, vibration, dust, moisture, and/or cold. (Do not use/keep this unit in a car etc.)
 - 2 Locate this unit away from other electrical appliances, motors, or transformers to avoid humming sounds.
 - 3 Do not expose this unit to sudden temperature changes from cold to hot, and do not locate this unit in an environment with high humidity (i.e. a room with a humidifier) to prevent condensation inside this unit, which may cause an electrical shock, fire, damage to this unit, and/or personal injury.
 - 4 Avoid installing this unit where foreign objects may fall onto this unit and/or this unit may be exposed to liquid dripping or splashing. On the top of this unit, do NOT place:
 - Other components, as they may cause damage and/or discoloration on the surface of this unit.
 - Burning objects (i.e. candles), as they may cause fire, damage to this unit, and/or personal injury.
 - Containers with liquid in them, as they may fall and liquid may cause electrical shock to the user and/or damage to this unit.
 - 5 Do not cover this unit with a newspaper, tablecloth, curtain, etc. in order not to obstruct heat radiation. If the temperature inside this unit rises, it may cause fire, damage to this unit, and/or personal injury.
 - 6 Do not operate this unit upside-down. They may overheat, possibly causing damage.
 - 7 Do not use force on switches, knobs, and/or cords.
 - 8 When disconnecting the power cable from the wall outlet, grasp the AC plug; do not pull the cord.
 - 9 Do not clean this unit with chemical solvents; this might damage the finish. Use a clean, dry cloth.
 - 10 Only the voltage specified on this unit must be used. Using this unit with a higher voltage than specified is dangerous and may cause fire, damage to this unit, and/or personal injury. Yamaha will not be held responsible for any damage resulting from use of this unit with a voltage other than that specified.
 - 11 Do not attempt to modify or fix this unit. Contact qualified Yamaha service personnel when any service is needed. The cabinet should never be opened for any reason.
 - 12 When not planning to use this unit for long periods of time (i.e. when going on vacation), disconnect the power cable from the AC wall outlet.
 - 13 Be sure to read the "TROUBLESHOOTING" section regarding common operating errors before concluding that the unit is faulty.
 - 14 Before moving this unit, disconnect the power cable from the wall outlet.

- 15 Be sure to use the AC adaptor supplied with this unit. Using an AC adaptor other than the one provided may cause fire or damage to this unit.
- 16 Install this unit near the wall outlet and where the power cable can be reached easily.
- 17 For added protection for this product during a lightning storm, or when it is left unattended and unused for long periods of time, unplug it from the wall outlet. This will prevent damage to the product due to lightning and powerline surges.
- 18 The batteries shall not be exposed to excessive heat such as sunshine, fire or the like.
 - Keep the batteries in a location out of reach of children. Batteries can be dangerous if a child were to put in his or her mouth.
 - If the batteries grow old, the effective operation range of the remote control decreases considerably. If this happens, replace the batteries as soon as possible.
 - Do not use old batteries together with new ones.
 - Do not use different types of batteries (such as alkaline and manganese batteries) together. Read the packaging carefully as these different types of batteries may have the same shape and color.
 - Exhausted batteries may leak. If the batteries have leaked, dispose of them immediately. Avoid touching the leaked material or letting it come into contact with clothing, etc. Clean the battery compartment thoroughly before installing new batteries.
 - If you plan not to use the unit for a long period of time, remove the batteries from the unit. Otherwise, the batteries will wear out, possibly resulting in a leakage of battery liquid that may damage the unit.
 - Do not throw away batteries with general house waste. Dispose of them correctly in accordance with your local regulations.

There is a chance that placing this unit too close to a CRT-based (Braun tube) TV set might impair picture color. Should this happen, move this unit away from the TV set.

WARNING
TO REDUCE THE RISK OF FIRE OR ELECTRIC SHOCK, DO NOT EXPOSE THIS UNIT TO RAIN OR MOISTURE.

Even if an iPhone or iPod is not connected to this unit, this unit is not disconnected from the AC power source as long as it is connected to the wall outlet. In this state, this unit is designed to consume a very small quantity of power.

CAUTION
Danger of explosion if battery is incorrectly replaced. Replace only with the same or equivalent type.

TROUBLESHOOTING

Refer to the table below if the unit does not operate properly. If the problem you are experiencing is not listed below, or if the instruction below does not help, turn off the unit, disconnect the power cable, and contact the nearest authorized Yamaha dealer or service center.

| Situation | Remedies and Points to Confirm |
|--|---|
| No sound | <ul style="list-style-type: none"> • Is the iPhone/iPod connected securely to the iPod dock? • Are PDX-11 and the external device's connector cable connected securely? Are the connector cable and the external device connected securely? • Is the AC adaptor connected securely? • Push the Power on/off to turn on PDX-11. • Is the volume turned down? • Have the batteries in PDX-11 been exhausted? |
| Even if the volume level is raised, the sound level does not increase. | It is possible that the protection circuitry has been activated by excessive volume. Reduce the volume level. |
| Even if the volume level of the connected iPhone/iPod is changed, the sound level does not change. | <ul style="list-style-type: none"> • Is the connected iPhone/iPod compatible with PDX-11? (☞ "SPECIFICATIONS") • Is the iPhone/iPod connected securely to the iPod dock? |
| The iPhone/iPod cannot be controlled using the remote control. | <ul style="list-style-type: none"> • If PDX-11 is being operated by batteries, it is possible that power-saving mode has been activated. (☞ "Before Use") • Are you outside of the remote control operating range? • Has the remote control's battery been exhausted, or is it inserted incorrectly? • Has the insulation sheet been removed? |
| PDX-11 cannot be controlled using the remote control. | <ul style="list-style-type: none"> • If PDX-11 is being operated by batteries, it is possible that power-saving mode has been activated. (☞ "Before Use") • Are you outside of the remote control operating range? • Has the remote control's battery been exhausted, or is it inserted incorrectly? • Has the insulation sheet been removed? |
| When PDX-11 is used outdoors, the remote control's operating range becomes smaller. | The remote control's operating range changes depending on the operating environment (amount of lighting, sunlight, etc.). |
| The green status indicator is lit, and the red status indicator blinks for 2 seconds only. | Is the connected iPhone/iPod compatible with PDX-11? Use a supported iPhone/iPod. (☞ "SPECIFICATIONS") |
| The green status indicator is lit, and the red status indicator is blinking quickly. | <ul style="list-style-type: none"> • Is the iPhone/iPod connected securely to the iPod dock? • Restart the iPhone/iPod. • Update the iPhone/iPod firmware to the latest version. |
| The green status indicator is lit, and the red status indicator is blinking slowly. | Have the batteries in PDX-11 been exhausted? |
| PDX-11 does not operate at all. | In some cases, resetting PDX-11 can solve the problem. To reset PDX-11, push and hold the Power on/off on the control panel for 10 seconds or more. |

SPECIFICATIONS

- Supported iPod.....iPod touch (1st, 2nd, 3rd and 4th generations), iPod classic, iPod with video, iPod nano (1st, 2nd, 3rd, 4th, 5th and 6th generations)
- Supported iPhone.....iPhone 4, iPhone 3GS, iPhone 3G, iPhone AUX
- Input connector.....ø 3.5 mm (1/8 in.) stereo mini jack
- Power supply
U.S.A. and Canada models.....AC 120 V, 60 Hz
Other models.....AC 100 to 240 V, 50/60 Hz
- Power consumption.....8 W
- Power consumption when power off and the iPhone/iPod is disconnected.....0.5 W or less
- AC adaptor.....MU18-D120150-A1, MU18-D120150-A2, MU18-D120150-A3, MU18-D120150-C4 or MU18-D120150-C5 <DC 12 V, 1.5 A>
(The AC adaptor's number differs according to the country or the area.)
- Battery supply.....LR6, AA, UM-3 × 6
8 hours of power at 0.18 W output (Alkaline Battery)

Dimensions

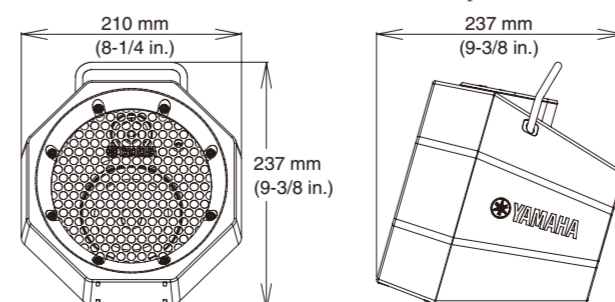

Weight : 1.5 kg (3.3 lbs)

* To play an unsupported iPod, such as a 4th generation (or earlier) iPod, iPod shuffle, iPod photo, and iPod mini, connect the iPod to AUX and use it as an external device.
* Specifications are subject to change without notice.
* The name plate is located on the bottom of the unit.

Made for iPod iPhone

"Made for iPod" and "Made for iPhone" mean that an electronic accessory has been designed to connect specifically to iPod or iPhone, respectively, and has been certified by the developer to meet Apple performance standards.
Apple is not responsible for the operation of this device or its compliance with safety and regulatory standards. Please note that the use of this accessory with iPod or iPhone may affect wireless performance.

iPhone, iPod, iPod classic, iPod nano, iPod touch and iTunes are trademarks of Apple Inc., registered in the U.S. and other countries.

