



AUDIO INTERFACE / INTERFACE AUDIO
INTERFAZ DE AUDIO / INTERFACE DE ÁUDIO
АУДИОИНТЕРФЕЙС / オーディオインターフェース

Ti01608-D2

Owner's Manual
Benutzerhandbuch
Mode d'emploi
Manual de instrucciones
Manual do Proprietário
Manuale di istruzioni
Руководство пользователя
取扱説明書

I/O RACK

English

Deutsch

Français

Español

Português

Italiano

Русский

日本語

EN

DE

FR

ES

PT

IT

RU

JA

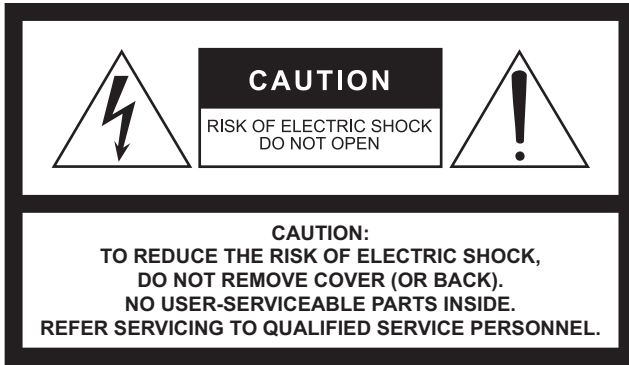

Explanation of Graphical Symbols Explication des symboles



The lightning flash with arrowhead symbol within an equilateral triangle is intended to alert the user to the presence of uninsulated “dangerous voltage” within the product’s enclosure that may be of sufficient magnitude to constitute a risk of electric shock to persons.

L'éclair avec une flèche à l'intérieur d'un triangle équilatéral est destiné à attirer l'attention de l'utilisateur sur la présence d'une « tension dangereuse » non isolée à l'intérieur de l'appareil, pouvant être suffisamment élevée pour constituer un risque d'électrocution.



The exclamation point within an equilateral triangle is intended to alert the user to the presence of important operating and maintenance (servicing) instructions in the literature accompanying the product.

Le point d'exclamation à l'intérieur d'un triangle équilatéral est destiné à attirer l'attention de l'utilisateur sur la présence d'instructions importantes sur l'emploi ou la maintenance (réparation) de l'appareil dans la documentation fournie.

IMPORTANT SAFETY INSTRUCTIONS

- 1 Read these instructions.
- 2 Keep these instructions.
- 3 Heed all warnings.
- 4 Follow all instructions.
- 5 Do not use this apparatus near water.
- 6 Clean only with dry cloth.
- 7 Do not block any ventilation openings. Install in accordance with the manufacturer's instructions.
- 8 Do not install near any heat sources such as radiators, heat registers, stoves, or other apparatus (including amplifiers) that produce heat.
- 9 Do not defeat the safety purpose of the polarized or grounding-type plug. A polarized plug has two blades with one wider than the other. A grounding type plug has two blades and a third grounding prong. The wide blade or the third prong are provided for your safety. If the provided plug does not fit into your outlet, consult an electrician for replacement of the obsolete outlet.
- 10 Protect the power cord from being walked on or pinched particularly at plugs, convenience receptacles, and the point where they exit from the apparatus.
- 11 Only use attachments/accessories specified by the manufacturer.
- 12 Use only with the cart, stand, tripod, bracket, or table specified by the manufacturer, or sold with the apparatus. When a cart is used, use caution when moving the cart/apparatus combination to avoid injury from tip-over.
- 13 Unplug this apparatus during lightning storms or when unused for long periods of time.
- 14 Refer all servicing to qualified service personnel. Servicing is required when the apparatus has been damaged in any way, such as power-supply cord or plug is damaged, liquid has been spilled or objects have fallen into the apparatus, the apparatus has been exposed to rain or moisture, does not operate normally, or has been dropped.



WARNING

TO REDUCE THE RISK OF FIRE OR ELECTRIC SHOCK, DO NOT EXPOSE THIS APPARATUS TO RAIN OR MOISTURE.

PRÉCAUTIONS CONCERNANT LA SÉCURITÉ

- 1 Lire ces instructions.
- 2 Conserver ces instructions.
- 3 Tenir compte de tous les avertissements.
- 4 Suivre toutes les instructions.
- 5 Ne pas utiliser ce produit à proximité d'eau.
- 6 Nettoyer uniquement avec un chiffon propre et sec.
- 7 Ne pas bloquer les orifices de ventilation. Installer l'appareil conformément aux instructions du fabricant.
- 8 Ne pas installer l'appareil à proximité d'une source de chaleur comme un radiateur, une bouche de chaleur, un poêle ou tout autre appareil (y compris un amplificateur) produisant de la chaleur.
- 9 Ne pas modifier le système de sécurité de la fiche polarisée ou de la fiche de terre. Une fiche polarisée dispose de deux broches dont une est plus large que l'autre. Une fiche de terre dispose de deux broches et d'une troisième pour le raccordement à la terre. Cette broche plus large ou cette troisième broche est destinée à assurer la sécurité de l'utilisateur. Si la fiche équipant l'appareil n'est pas compatible avec les prises de courant disponibles, faire remplacer les prises par un électricien.
- 10 Acheminer les cordons d'alimentation de sorte qu'ils ne soient pas piétinés ni coincés, en faisant tout spécialement attention aux fiches, prises de courant et au point de sortie de l'appareil.
- 11 Utiliser exclusivement les fixations et accessoires spécifiés par le fabricant.
- 12 Utiliser exclusivement le chariot, le stand, le trépied, le support ou la table recommandés par le fabricant ou vendus avec cet appareil. Si l'appareil est posé sur un chariot, déplacer le chariot avec précaution pour éviter tout risque de chute et de blessure.
- 13 Débrancher l'appareil en cas d'orage ou lorsqu'il doit rester hors service pendant une période prolongée.
- 14 Confier toute réparation à un personnel qualifié. Faire réparer l'appareil s'il a subi tout dommage, par exemple si la fiche ou le cordon d'alimentation est endommagé, si du liquide a coulé ou des objets sont tombés à l'intérieur de l'appareil, si l'appareil a été exposé à la pluie ou à de l'humidité, si l'appareil ne fonctionne pas normalement ou est tombé.



AVERTISSEMENT

POUR RÉDUIRE LES RISQUES D'INCENDIE OU DE DÉCHARGE ÉLECTRIQUE, N'EXPOSEZ PAS CET APPAREIL À LA PLUIE OU À L'HUMIDITÉ.

(502-M01 UL 60065-1 01)

FCC INFORMATION (U.S.A.)

1. IMPORTANT NOTICE: DO NOT MODIFY THIS UNIT!

This product, when installed as indicated in the instructions contained in this manual, meets FCC requirements. Modifications not expressly approved by Yamaha may void your authority, granted by the FCC, to use the product.

2. IMPORTANT:

When connecting this product to accessories and/or another product use only high quality shielded cables. Cable/s supplied with this product MUST be used. Follow all installation instructions. Failure to follow instructions could void your FCC authorization to use this product in the USA.

3. NOTE:

This product has been tested and found to comply with the requirements listed in FCC Regulations, Part 15 for Class "B" digital devices. Compliance with these requirements provides a reasonable level of assurance that your use of this product in a residential environment will not result in harmful interference with other electronic devices. This equipment generates/uses radio frequencies and, if not installed and used according to the instructions found in the users manual, may cause interference harmful to the operation of other electronic devices. Compliance with FCC regulations does not guarantee that interference will not occur in all installations. If this product is found to be the source of interference, which can be determined by turning the unit "OFF" and "ON", please try to eliminate the problem by using one of the following measures:

- Relocate either this product or the device that is being affected by the interference.
- Utilize power outlets that are on different branch (circuit breaker or fuse) circuits or install AC line filter/s.
- In the case of radio or TV interference, relocate/reorient the antenna. If the antenna lead-in is 300 ohm ribbon lead, change the lead-in to co-axial type cable.

If these corrective measures do not produce satisfactory results, please contact the local retailer authorized to distribute this type of product. If you cannot locate the appropriate retailer, please contact Yamaha Corporation of America, 6600 Orangethorpe Avenue, Buena Park, CA 90620, U.S.A.

The above statements apply ONLY to those products distributed by Yamaha Corporation of America or its subsidiaries.

(529-M04 FCC class B YCA 02)

COMPLIANCE INFORMATION STATEMENT (Supplier's declaration of conformity procedure)

Responsible Party : Yamaha Corporation of America
Address : 6600 Orangethorpe Avenue, Buena Park, CA. 90620, U.S.A.
Telephone : 714-522-9011
Type of Equipment : AUDIO INTERFACE
Model Name : Tio1608-D2

This device complies with Part 15 of the FCC Rules.

Operation is subject to the following two conditions:

- 1) this device may not cause harmful interference, and
- 2) this device must accept any interference received, including interference that may cause undesired operation.

(529-M02 FCC sdoc YCA 02)

Included items..... 5

PRECAUTIONS 6

Introduction 8

 Updating the firmware 8

 Dante support 8

 Precautions when rackmounting 8

 Recessed Installation..... 8

Device features 9

 Front panel..... 9

 Rear panel 11

Connection methods 14

 Quick Config (automatic setup)..... 14

 Manual setup 15

 Head amp control 15

Troubleshooting 16

 Troubleshooting 16

How to read the indicators 17

Specifications 121

 General Specifications 121

 Input Output Digital I/O Character..... 122

 Dimensions 123

Included items

- Owner's Manual (this document)
- Power cord
- Rubber feet x4

NOTE

The rubber feet included in this package can be attached to the product to prevent slippage when it is to be used on a slippery surface.

Information for users on collection and disposal of old equipment:



This symbol on the products, packaging, and/or accompanying documents means that used electrical and electronic products should not be mixed with general household waste. For proper treatment, recovery and recycling of old products, please take them

to applicable collection points, in accordance with your national legislation.

By disposing of these products correctly, you will help to save valuable resources and prevent any potential negative effects on human health and the environment which could otherwise arise from inappropriate waste handling.

For more information about collection and recycling of old products, please contact your local municipality, your waste disposal service or the point of sale where you purchased the items.

For business users in the European Union:

If you wish to discard electrical and electronic equipment, please contact your dealer or supplier for further information.

Information on Disposal in other Countries outside the European Union:

This symbol is only valid in the European Union. If you wish to discard these items, please contact your local authorities or dealer and ask for the correct method of disposal.

(58-M02 WEEE en 01)

PRECAUTIONS

PLEASE READ CAREFULLY BEFORE PROCEEDING

Please keep this manual in a safe place for future reference.



WARNING

Always follow the basic precautions listed below to avoid the possibility of serious injury or even death from electrical shock, short-circuiting, damages, fire or other hazards. These precautions include, but are not limited to, the following:

If you notice any abnormality

- If any of the following problems occur, immediately turn off the power switch and disconnect the electric plug from the outlet.
 - The power cord or plug becomes frayed or damaged.
 - Unusual smells or smoke are emitted.
 - Some object, or water has been dropped into the product.
 - There is a sudden loss of sound during use of the product.
 - Cracks or other visible damage appear on the product.
- Then have the product inspected or repaired by qualified Yamaha service personnel.

Power supply

- Do not place the power cord near heat sources such as heaters or radiators, and do not excessively bend or otherwise damage the cord, place heavy objects on it, or place it in a position where anyone could walk on, trip over, or roll anything over it.
- Only use the voltage specified as correct for the product. The required voltage is printed on the name plate of the product.
- Use the supplied power cord/plug only. If you intend to use the product in an area other than in the one you purchased, the included power cord may not be compatible. Please check with your Yamaha dealer.
- Do not use the supplied cord/plug for other products.
- Check the electric plug periodically and remove any dirt or dust which may have accumulated on it.
- Make sure to fully insert the electric plug to prevent electric shocks or fire.
- When setting up the product, make sure that the AC outlet you are using is easily accessible. If some trouble or malfunction occurs, immediately turn off the power switch and disconnect the plug from the outlet. Even when the power switch is turned off, as long as the power cord is not unplugged from the wall AC outlet, the product will not be disconnected from the power source.
- Remove the electric plug from the outlet when the product is not to be used for extended periods of time.
- Do not touch the product or the electric plug during an electrical storm.
- Be sure to connect to an appropriate outlet with a protective grounding connection. Improper grounding can result in electrical shock, fire, or damage.

Do not open

- This product contains no user-serviceable parts. Do not attempt to disassemble the internal parts or modify them in any way.

Water warning

- Do not expose the product to rain, use it near water or in damp or wet conditions, or place on it any containers (such as vases, bottles or glasses) containing liquids which might spill into any openings.
- Never insert or remove an electric plug with wet hands.

Fire warning

- Do not place any burning items or open flames near the product, since they may cause a fire.

Hearing loss

- Before turning the power of all devices on or off, make sure that all volume levels are set to the minimum. Failing to do so may result in hearing loss, electric shock, or device damage.
- When turning on the AC power in your audio system, always turn on the power amplifier LAST, to avoid hearing loss and speaker damage. When turning the power off, the power amplifier should be turned off FIRST for the same reason.



CAUTION

Always follow the basic precautions listed below to avoid the possibility of physical injury to you or others. These precautions include, but are not limited to, the following:

Power supply

- When removing the electric plug from the product or an outlet, always hold the plug itself and not the cord. Pulling by the cord can damage it.

Location and connection

- Do not place the product in an unstable position or a location with excessive vibration, where it might accidentally fall over and cause injury.
- Keep this product out of reach of children. This product is not suitable for use in locations where children are likely to be present.
- Do not block the vents. This product has ventilation holes at the front/rear/sides to prevent the internal temperature from becoming too high. In particular, do not place the product on its side or upside down. Inadequate ventilation can result in overheating, possibly causing damage to the product(s), or even fire.
- If the product is mounted in an EIA standard rack, carefully read the section "Precautions when rackmounting" on page 8. Inadequate ventilation can result in overheating, possibly causing damage to the product(s), malfunction, or even fire.

- Do not place the product in a location where it may come into contact with corrosive gases or salt air. Doing so may result in malfunction.
- Before moving the product, remove all connected cables.

Maintenance

- Remove the power plug from the AC outlet when cleaning the product.

Handling caution

- Do not insert your fingers or hands in any gaps or openings on the product (vents, panel, etc.).
- Do not rest your weight on the product or place heavy objects on it.

NOTICE

To avoid the possibility of malfunction/damage to the product, damage to data, or damage to other property, follow the notices below.

Handling and maintenance

- Do not use the product in the vicinity of a TV, radio, or other electric products. Otherwise, the product, TV, or radio may generate noise.
- Do not expose the product to excessive dust or vibration, or extreme cold or heat, in order to prevent the possibility of panel disfiguration, unstable operation, or damage to the internal components.
- Do not install in locations where temperature changes are severe. Otherwise, condensation may form on the inside or the surface of the product, causing it to break.
- If there is reason to believe that condensation might have occurred, leave the product for several hours without turning on the power until the condensation has completely dried out, in order to prevent possible damage.
- Do not place vinyl, plastic or rubber objects on the product, since this might cause alteration or discoloration of the panel.
- Clean the product with a dry and soft cloth. Do not wipe product surfaces with sodium hypochlorite, alcohol, benzene, paint thinners, cleaning fluids, or a chemical-impregnated wiping cloth, which could cause discoloration or change surface characteristics.

Information

About copyrights

- Copying of the software or reproduction of this manual in whole or in part by any means is expressly forbidden without the written consent of the manufacturer.

Protection of copyright

- Do not use this product for any purpose that may infringe upon the rights of any third party including copyrights, as established by law in each country or region.
- Yamaha bears no responsibility for any infringement upon third party rights that may occur as a result of using this product.

About functions/data bundled with the product

- This product uses the Dante module provided by Audinate. The Dante module used in this product can be confirmed in Dante Controller. For more information about the open source licenses used for each Dante module, please visit Audinate's website. <https://www.audinate.com/software-licensing>
- XLR-type connectors are wired as follows (IEC60268 standard): pin 1: ground, pin 2: hot (+), and pin 3: cold (-).

About this manual

- The illustrations and screens as shown in this manual are for instructional purposes only.
- Yamaha Corporation makes no representations or warranties with regard to the use of the software and documentation and cannot be held responsible for the results of the use of this manual and the software.
- The company names and product names in this manual are the trademarks or registered trademarks of their respective companies.
- Software may be revised and updated without prior notice.

About disposal

- This product contains recyclable components. When disposing of this product, please contact the appropriate local authorities.

Yamaha cannot be held responsible for damage caused by improper use or modifications to the product, or data that is lost or destroyed.

Thank you for purchasing the Yamaha Tio1608-D2 I/O rack. The Tio1608-D2 is an I/O rack that features 16 channels of analog inputs and 8 channels of analog outputs.

In order to take full advantage of this product's features, and to enjoy years of trouble-free use, please read this document before you begin using the product. After you have read this document, please keep it in a safe place.

Updating the firmware

The firmware contained in this product can be updated to take advantage of new features, feature improvements, and bug fixes. The product uses two types of firmware.

- Main unit firmware
- Dante module firmware

Details about updating the firmware are available online.

<https://www.yamahaproaudio.com/>

For information about updating and setting up the console, please refer to the firmware update guide available on the website.

NOTE

When updating this product's Dante module firmware, make sure you also update the Dante module firmware contained in other connected devices.

Dante support

This product uses the Dante digital audio network protocol to send and receive audio signals. Dante is a protocol developed by Audinate that is designed to deliver multichannel audio signals at various sampling and bit rates, as well as device control signals over a Gigabit Ethernet network.

For information about Dante, please visit the Audinate website.

<http://www.audinate.com/>

You can also find information about Dante and Dante-compatible products on the Yamaha Pro Audio website.

<https://www.yamahaproaudio.com/>

NOTE

Please do not use the EEE function (*) of network switches in a Dante network.

The EEE function may deteriorate the clock synchronization performance and interrupting audio.

Therefore we strongly recommend that:

- If you use managed switches, ensure that they allow EEE to be disabled. Make sure that EEE is disabled on all ports used for real-time Dante traffic.
- If you use unmanaged switches, make sure to not use network switches that support the EEE function, since EEE operation cannot be disabled in these switches.

* EEE (Energy Efficient Ethernet) is a technology that reduces switch power consumption during periods of low network traffic. It is also known as Green Ethernet and IEEE802.3az.

Precautions when rackmounting

This product is designed to function in environments with a temperature of 0 to 40°C. If you install this product together with multiple units of the same device or other devices in a standard EIA rack, the heat produced by the devices may raise the ambient temperature inside the rack enclosure to the point where performance is affected. To ensure that the heat produced by this product can be dissipated appropriately, please ensure the following conditions when rackmounting it.

- When mounting the unit in a rack with devices such as power amplifiers that generate a significant amount of heat, leave at least 1U of unused space between the unit and the other device. Additionally, install a ventilation panel in this unused space or leave it open to ensure adequate cooling.
- To ensure sufficient airflow, leave the back of the rack open and position it at least 10 centimeters from walls or other surfaces. If the back of the rack cannot be left open, install a commercially available fan or similar ventilating option to secure sufficient airflow. If you install a fan kit, there may be cases in which closing the back of the rack will produce a greater cooling effect. Refer to the documentation included with the rack and/or fan unit details.

Recessed Installation

If you want to recess the front panel surface of the device from the front edge of the rack, you can adjust the position of the rack mount brackets to recess the device by 50mm, as shown in the illustration below.

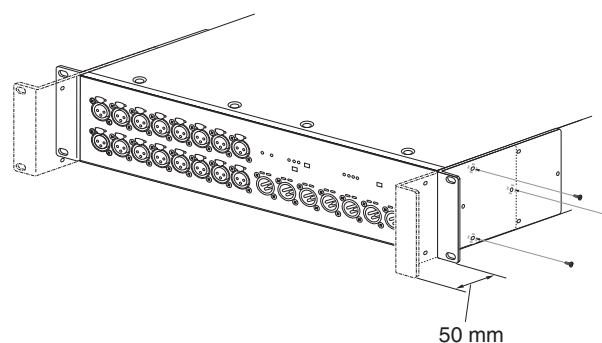

NOTE

When you install the brackets, use the same screws that you just removed.

Front panel

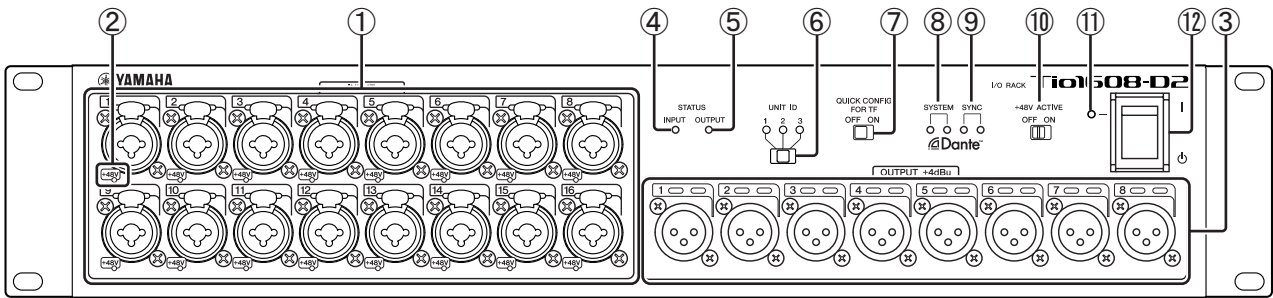

① [INPUT] 1–16

Combination connectors that support both XLR 3-pin cable connectors and TRS phone plug. Use these connectors to connect mics and instruments.

Nominal input level is -62 dBu to +10 dBu.

When connecting a cable that uses an XLR 3-pin cable connector, make sure you supply +48 V phantom power to any devices that require it.

NOTE

The PAD will be switched on or off internally when the analog gain of the internal head amp is adjusted between +17dB and +18dB. When using phantom power, noise may be generated if there is a difference in the impedance between the hot and cold of the device connected to an input connector.

② [+48V]

These indicators light when +48 V phantom power is turned on for the corresponding input channels. You can use a compatible mixing console or other device to turn phantom power on and off. If the [+48V ACTIVE] is turned off, no phantom power will be supplied even if phantom power is turned on for individual channels (although the [+48V] will still flash).

⚠ CAUTION

- Make sure that phantom power is turned off unless it is needed.
- When turning on phantom power, make sure that no equipment other than phantom-powered devices such as condenser microphones are connected to the corresponding [INPUT] connectors. Supplying phantom power to a device that does not require it can damage the device.
- Do not connect or disconnect a device while phantom power is being supplied to it. Doing so can damage the connected device and the unit itself.
- To prevent damage to speakers, make sure that power amplifiers and powered speakers are turned off when turning phantom power on or off. We also recommend setting all digital mixing console output controls to their minimum settings when turning phantom power on or off. Sudden high-volume sound caused by turning phantom power on or off could damage equipment and hearing.

③ [OUTPUT +4dBu] 1–8

These XLR 3-pin chassis balanced connectors deliver analog output from the unit's corresponding output channels. Nominal output level is +4 dBu.

NOTICE

If this product's balanced outputs are connected to an unbalanced audio source, a difference in ground potential could cause a malfunction. Make sure each device has the same ground potential. The cable used to connect an unbalanced device should be pin 1: ground, pin 3: cold.

④ [STATUS INPUT]

This indicator indicates the status of the signal being input to the analog input connectors.

If the signal input to any channel reaches or exceeds -34 dBFS, the indicator lights in green; if the signal reaches or exceeds -3 dBFS, the indicator lights in red. The indicator flashes in red if the input is muted, if the system clock is being synced, or if there is a system error.

⑤ [STATUS OUTPUT]

If the signal level of any analog output connector reaches or exceeds -34 dBFS, this indicator lights in green.

The indicator flashes in red if the output is muted, if the system clock is being synced, or if there is a system error.

⑥ [UNIT ID]

Determines the unit's identifier (i.e., unit ID) when using Quick Config. When using multiple units, set a unique ID (1–3) to each unit.

When not using Quick Config, this switch and the DIP switches on the rear of the unit determine the ID.

(→page 11)

Turn the unit off before changing the [UNIT ID] position. If you move the switch while the unit is turned on, the new switch position is not applied.

See "Connection methods" (→page 14) for information about Quick Config.

NOTE

If TF Quick Config or DM3 Auto Setup functionality is used in a system with a combination of Tio1608-D2 and older Tio1608-D models, make sure Tio1608-D2 UNIT ID settings do not conflict with Tio1608-D UNIT ID settings either.

- ⑦ **[QUICK CONFIG FOR TF]**
Turns Quick Config on and off.
Set this switch setting to OFF if Quick Config is not used or multiple mixers are connected via a network.
Turn the unit off before changing the [QUICK CONFIG FOR TF] position. If this setting is set while the power is ON, it is not applied in the main unit until the power is switched OFF and ON.
See "Connection methods" (→page 14) for information about Quick Config.
- ⑧ **[SYSTEM]**
Indicate the status of the Tio1608-D2.
During normal operation, the green indicator is lit and the red indicator is off. When the unit is turned on, if the green indicator is off and the red indicator is lit or is flashing, an error has occurred. For more information, see "How to read the indicators". (→page 17)
- ⑨ **[SYNC]**
Indicate the status of the unit's internal Dante clock sync.
When the green indicator is lit, the unit is the clock follower, and the clock is in sync. When the green indicator is flashing, the unit is the clock leader. When the unit is turned on, the green indicator should either light or flash; if the indicator is off, an error has occurred. For more information, see "How to read the indicators". (→page 17-18)
- ⑩ **[+48V ACTIVE]**
Turns the unit's +48 V phantom power on and off. If the [+48V ACTIVE] is off, no phantom power is supplied to the input connectors even if phantom power is turned on for individual inputs. In this case, the [+48V] for individual inputs will still light, even though no phantom power will be supplied.
You can change the switch position while the unit is turned on.
- ⑪ **Power indicator**
Indicates whether the unit is turned on or off.
- ⑫ **Power switch** | / 
Turns the unit on and off.

NOTICE

Rapidly turning the unit on and off in succession can cause it to malfunction. After turning the unit off, wait for about 6 seconds before turning it on again.

Rear panel

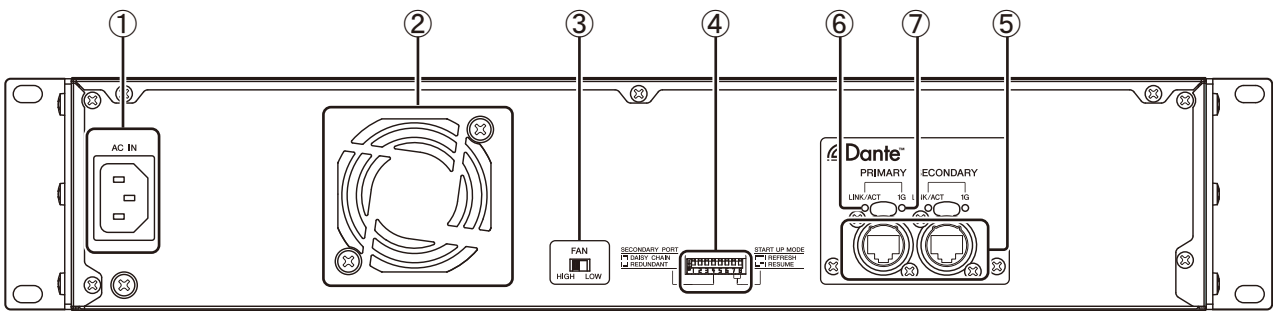

① [AC IN]

Connect the included power cord. When connecting to a power outlet, first connect the power cord to the unit, then connect the power cord to the power outlet.

⚠ CAUTION

Make sure the unit is turned off before connecting or disconnecting the power cord.

② Cooling vent

The Tio1608-D2 contains a cooling fan. The cooling air is exhausted here, so please be careful not to block this vent. The air is taken in through the ventilation ports at the front.

⚠ CAUTION

Do not block the ventilation ports (heat dissipating slits) on this product. This product has ventilation ports at the front/rear/sides to prevent the internal temperature from becoming too high. If the ventilation ports are blocked, heat will get trapped inside the product, which may cause malfunction or fire.

③ [FAN]

Allows you to set the unit's internal cooling fan to run at high or low speed. The switch is set at the factory to [LOW], but as long as the unit is operated within the specified ambient temperature range either the [LOW] or [HIGH] setting can be used. The [HIGH] setting is recommended if the ambient temperature is high, if the unit is in direct sunlight (even if the ambient temperature is within the specified operating range), and in any situation in which fan noise is not a problem. When mounting three or more units without leaving space between each unit, set each unit's fan speed to HIGH.

You can change the switch position while the unit is turned on.

④ DIP switches

Determines the unit's start up mode.

Make sure that the unit is turned off before adjusting the DIP switches. If you adjust the switches while the unit is turned on, the new switch positions are not applied.

The following information explains how the DIP switch positions.

• Switches 1 and 2 (unit ID)

These DIP switches, along with the [UNIT ID], determine the unit's UNIT ID when Quick Config is not used.

The UNIT ID is determined as follows.

Switch position	[UNIT ID] = 1	[UNIT ID] = 2	[UNIT ID] = 3
	01	02	03
	04	05	06
	07	08	09
	0A	0B	0C

When Quick Config is used, these switches are disabled.

• Switch 3 (initialize mode)

This DIP switch is used to reset the unit to its factory default settings.

After the unit is reset, it starts up using the system mode that corresponds to the position of switches 7 and 8.

Switch position	Initialize mode
	Initialize mode is off (unit will not be reset when it is turned on)
	Initialize mode is on (unit will be reset when it is turned on)

NOTE

If switches 7 and 8 are set to the "update mode" or "diagnostic mode" positions, the unit will not be reset.

- **Switches 3, 7 and 8 (Tio1608-D compatibility mode)**

This mode is used to connect to older models that are not compatible with the Tio1608-D2.

In the compatibility mode, the sampling frequency is set to the maximum 48 kHz and external devices recognize Tio1608-D2 as Tio1608-D.

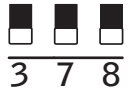
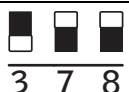
Switch position	Operating mode
 3 7 8	Tio1608-D compatibility mode
 3 7 8	Cancel the Tio1608-D compatibility mode (initialize mode)

- **Activating the Tio1608-D compatibility mode**



Configure the dip switches as shown above for "Tio1608-D compatibility mode" and then switch the power ON. When the red indicators on the front panel stop flashing and only the green indicators are flashing, that indicates the compatibility mode has been successfully activated. Then switch the power OFF, reconfigure the dip switch settings appropriately, and switch the power back ON before using the system. The green [SYSTEM] indicators will flash for about 20 seconds only after switching to the Tio1608-D compatibility mode.

- **Canceling the Tio1608-D compatibility mode**

Configure the dip switches as shown above for "Cancel the Tio1608-D compatibility mode" and then switch the power ON. When the red indicators on the front panel stop flashing and only the green indicators are flashing, that indicates the compatibility mode has been successfully canceled. Then switch the power OFF, reconfigure the dip switch settings appropriately, and switch the power back ON before using the system.

- **Switch 4 (Dante SECONDARY port mode)**

This switch determines the operating mode of the Dante [SECONDARY].

Switch position	[SECONDARY] operating mode
 4	Daisy chain connection
 4	Redundant connection





When Quick Config is used, these switches are disabled.

NOTE

When the Switch 4 is set to "Redundant connection", the head amp control function (→page 15) is only available via the Dante [PRIMARY].





- **Switches 5 and 6 (IP address mode)**

These switches determine how the unit's IP address is set.

Switch position	IP address mode
 5 6	Auto IP (link local)
 5 6	DHCP
 5 6	Static IP Auto (192.168.0.ID)
 5 6	Static IP Manual The IP address is specified from an external device such as R Remote V3.

- **Switches 7 and 8 (start up mode)**

These switches determine how the unit starts up during start up mode. When set to "refresh" mode, the settings of the mixer are applied when the unit starts up. When set to "resume" mode, the unit returns to the same state as the last time it was used.

Switch position	Start up mode
 7 8	REFRESH mode (normal operation)
 7 8	RESUME mode (normal operation)
 7 8	Update mode
 7 8	Diagnostic mode

When Quick Config is used, the "normal operation" mode settings are disabled.

NOTE

- Update mode and diagnostic mode are used when performing maintenance on the unit. Normally you will not use these modes.
- Update mode and diagnostic mode can be enabled even when using Quick Config. Normally you will not use these modes.

⑤ Dante [PRIMARY]/[SECONDARY]

etherCON CAT5 connector that connects the unit to a Dante device, such as a NY64-D digital audio interface card. When DIP switch 4 is set to the daisy-chain connection position (i.e., up position), signals received on one connector are sent out via the other connector. When DIP switch 4 is set to the redundant connection position (i.e., down position), the [SECONDARY] functions as a backup and carries the same signals as the [PRIMARY]. If for some reason signals cannot be carried over the [PRIMARY] (for example, because the cable becomes damaged or disconnected, or because the network switch malfunctions), the unit switches to the [SECONDARY].

NOTICE

Use an STP (Shielded Twisted Pair) cable to prevent electromagnetic interference. Make sure that the metal parts of the plugs are electrically connected to the STP cable shield by conductive tape or comparable means.

NOTE

- We recommend using RJ-45 plugs that are compatible with Neutrik etherCON CAT5 connectors. You can also use cables with standard RJ-45 plugs.
- The maximum length of cable that can be used varies depending on the type of cable. When using CAT5e cables, data can be sent between devices that are connected by up to 100 m of cable.

⑥ [LINK/ACT]

Indicate the status of the signals carried by the [PRIMARY] and [SECONDARY]. If an indicator is flashing quickly, the corresponding Ethernet cable is not connected properly.

⑦ [1G]

Indicate the connection status of the [PRIMARY] and [SECONDARY]. If an indicator is lit, the corresponding connector is connected to a Gigabit Ethernet network.

This section explains the different methods for connecting the Tio1608-D2 to other Dante devices. To connect to a non-TF series mixer, refer to the mixer instruction manual.

Quick Config (automatic setup)

When connecting the unit to a TF series mixing console, Quick Config makes it easy to set up the unit automatically. It allows you to connect up to three Tio1608-D2 units to one TF series mixing console, and configures Dante network settings and audio signal settings in one operation.

NOTE

- To use Quick Config functionality, activate the Tio1608-D compatibility mode.
- Tio1608-D2 models can be connected to a mixture of Tio1608-D2 and older Tio1608-D models.
- An NY64-D audio interface card (sold separately) is required to connect a Tio1608-D2 to a TF series mixing console.

Tio1608-D2 procedure

1. With all the units turned off, set the DIP switches on the rear panel to the up position.

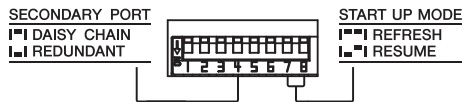

2. Set the [QUICK CONFIG FOR TF] on the front panel to the [ON] position.



3. Set the [UNIT ID] on the front panel to the desired position. If you are using multiple Tio1608-D2 units, make sure each unit has a unique UNIT ID setting.

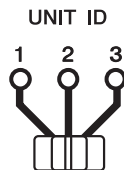

NOTE

If used in combination with older Tio1608-D models, specify UNIT ID settings that do not conflict with the Tio1608-D units.

4. Use Ethernet cables to connect the Tio1608-D2 to the NY64-D card (installed in the TF series mixing console) or to other Tio1608-D2 units in a daisy-chain configuration, as shown below.

When using Quick Config, the units will operate the same whether you connect the Ethernet cables to the Dante [PRIMARY] or [SECONDARY].

When connecting 3 units

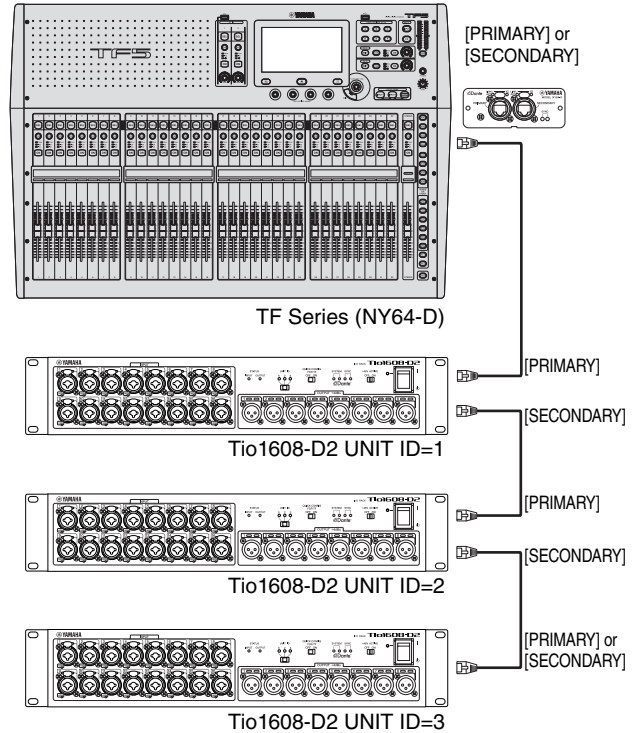

5. Turn each device on.

TF series mixing console procedure

6. Display the console's SYSTEM SETUP → SLOT SETUP screen, and confirm that Quick Config is enabled.

Now the TF series mixing console can recognize the Tio1608-D2 units, and all Dante settings and input and output patching settings will be configured automatically.

When the Quick Config button is displayed in white, Quick Config is enabled. If the button is grayed out, click it. If you cannot enable Quick Config, return to step 1 and confirm that the Tio1608-D2 is configured properly.



- To assign the Tio1608-D2 inputs to the TF series mixing console, set the input select on the console's INPUT screen to "SLOT".

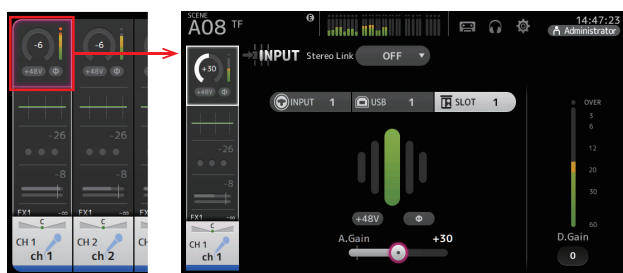

NOTE

While the INPUT screen is displayed, the menu keys can be used to change multiple currently selected FADER BANK inputs at the same time.

- Adjust the input gain and other settings as necessary.

Quick config is now complete.

Settings configured by Quick Config

Quick Config applies the following settings.

• **Dante settings**

Word clock	48 kHz (follower), no pull up/down
Latency	0.5 ms
Encoding	24-bit PCM
SECONDARY port mode	Daisy chain
Patching	Refer to the table below
IP address	Previous setting is used

NOTE

Quick Config does not configure analog input parameters.

• **Patching**

	Tio input		TF input		TF output		Tio output
#1	ID 1, Input 1	→	Channel 1		AUX 1	→	ID 1, Output 1
	ID 1, Input 2	→	Channel 2		:		:
	:		:		AUX 6	→	ID 1, Output 6
	ID 1, Input 16	→	Channel 16		Stereo L	→	ID 1, Output 7
					Stereo R	→	ID 1, Output 8
#2	ID 2, Input 1	→	Channel 17		AUX 7	→	ID 2, Output 1
	ID 2, Input 2	→	Channel 18		:		:
	:		:		AUX 12	→	ID 2, Output 6
	ID 2, Input 16	→	Channel 32		Stereo L	→	ID 2, Output 7
					Stereo R	→	ID 2, Output 8
#3	ID 3, Input 1	→	Channel 33		AUX 13	→	ID 3, Output 1
	ID 3, Input 2	→	Channel 34		:		:
	:		:		AUX 18	→	ID 3, Output 6
	ID 3, Input 8	→	Channel 40		AUX 19	→	ID 3, Output 7
					AUX 20	→	ID 3, Output 8

NOTE

- Even if only UNIT ID 2 or 3 is used, channels are patched as shown above based on the UNIT ID number.
- After you have used Quick Config to configure the settings, you can use Dante Controller to change the individual settings. However, each time the Tio1608-D2 is turned on, Dante Controller settings will be replaced by the Quick Config settings. For this reason, we recommend that you turn Quick Config off if you are using Dante Controller.

Manual setup

If Quick Config is not used or if connecting to a mixer that does not support Quick Config, configure settings manually based on the given connection environment.

Tio1608-D2 procedure

- With the unit turned off, set the [QUICK CONFIG FOR TF] on the front panel to the [OFF] position.
- Refer to the information on page 11 - 12 and set the DIP switches to the desired positions.
- Set the [UNIT ID] on the front panel to the desired position.
- Use Ethernet cables to connect the Tio1608-D2 to your Dante device.
- Turn each device on.

Dante settings

When using manual setup, use Dante Controller to configure Dante settings.

Dante Controller is a computer program that you can use to configure Dante network settings and audio signal patching settings. To use the program, download it from the Audinate website. (Dante Controller v3.2.1 or later is compatible with Tio1608-D2.)

For information about Dante Controller, refer to the Dante Controller documentation.

When using manual setup, you will need to use Dante Controller to configure the following settings at a minimum. (You can configure other settings as desired.)

- Input and output patching settings (Network View → Routing)
- Clock leader settings (Network View → Clock Status)
- Sampling frequency settings (Device View → Config)

Head amp control

You can use a Yamaha digital mixer or other device to control the Tio1608-D2 head amp.

When the unit is connected to a TF series mixing console, you can control the unit's head amp just as you would adjust the console's head amp.

When using a CL or QL series digital mixer, you can control or use the following parameters.

- HA gain
- +48 V phantom power on/off
- HPF on/off
- HPF frequency cutoff adjustment
- Mute off
- +48 V phantom power on/off display
- Analog input level meter display
- Firmware version display
- Device identify
- Dante SYSTEM and SYNC indicator information

NOTE

When the Dante SECONDARY port mode (→page 12) is set to "Redundant connection", the head amp control function is only available via the Dante [PRIMARY]. The Dante [SECONDARY] is not available for this function.



Troubleshooting

Issue	Cause	Solution
No power, power indicator does not light	Power cord not connected.	Make sure the power cord is connected (→page 11).
	The power switch is turned off.	Set the power switch to the "on" position. If you still cannot resolve the problem, please contact your nearest Yamaha representative.
Unit is not receiving an input signal	Cables not connected properly.	Make sure all cables are connected properly.
	Source device is not sending a signal to the unit.	Output a signal from the source device and confirm that the [STATUS INPUT] light.
	Internal head amp gain is too low.	Adjust the internal head amp gain to an appropriate level.
	DIP switches are set to "refresh" mode but device that controls the Tio1608-D2 has not started up.	Start the device that will control the Tio1608-D2 and send the settings to the Tio1608-D2.
Input level too low	Condenser mic is connected.	Set the [+48V ACTIVE] to the "on" position.
		Use the device that controls the Tio1608-D2 to turn on phantom power for the corresponding channel.
	Internal head amp gain is too low.	Adjust the internal head amp gain to an appropriate level.
No sound heard	Cables not connected properly.	Make sure all cables are connected properly.
	DIP switches are set to "refresh" mode but device that controls the Tio1608-D2 has not started up.	Start the device that will control the Tio1608-D2 and send the settings to the Tio1608-D2.
	The [QUICK CONFIG FOR TF] is ON in an environment where Quick Config cannot be used (when connected to mixer that does not support Quick Config or when settings were configured in Dante Controller).	Set the [QUICK CONFIG FOR TF] to OFF and then try configuring the patch or other settings again.
	The sampling frequency does not match the connected mixer.	Set the settings correctly in Dante Controller or other software.
	An error has occurred.	Check the status of [SYSTEM] and [SYNC] and then resolve the problem accordingly. (→page 17-18)
[UNIT ID] or DIP switch settings not applied	You changed the switch positions while the unit was turned on.	Make sure the unit is turned off before changing the switch positions.





You can use the [SYSTEM] and [SYNC] to confirm the unit's status.
The indicators can relay operational status, error status, and warnings.

Error status

If one of the following errors has occurred, the device will not operate. Until the error is resolved, the green [SYSTEM] will be turned off, and all indicators for all I/O channels will continue to flash.
In addition, certain errors will cause the red [SYSTEM] to light or flash.



[SYSTEM]	Description	Possible Solution
<p>SYSTEM</p>  <p>Off Flashes 2 times</p>	Internal Dante error has occurred.	The unit is malfunctioning. Please contact your nearest Yamaha representative.
<p>SYSTEM</p>  <p>Off Flashes 3 times</p>	MAC address setting is damaged and Dante communication is not possible.	
<p>SYSTEM</p>  <p>Off Lit</p>	Duplicate UNIT ID was found.	Make sure each UNIT ID is only used once on the Dante network.

The following errors affect the settings or the hardware. However, the device will still be usable. The green [SYSTEM] will light, and all indicators for all I/O channels will work normally.
In addition, certain errors will cause the red [SYSTEM] to light or flash.

[SYSTEM]	Description	Possible Solution
<p>SYSTEM</p>  <p>Lit Flashing</p>	The number of Dante transmit flows exceeded the limit.	Reduce the number of flows by, for example, using Dante Controller to change some of the transmit flows to multicast.
<p>SYSTEM</p>  <p>Lit Flashes 2 times</p>	Error occurred when communicating with the head amp.	Turn the unit off and then on again. If this does not resolve the problem, please contact your nearest Yamaha representative.
<p>SYSTEM</p>  <p>Lit Flashes 3 times</p>	Internal memory has been corrupted.	If using RESUME mode, turn the unit off and then on again. If this does not resolve the problem, please contact your nearest Yamaha representative.
<p>SYSTEM</p>  <p>Lit Lit</p>	You changed the positions of the device setting DIP switches, or changed the Dante settings from Dante Controller. Therefore, the positions of the device setting DIP switches do not match the actual Dante settings.	If the Device Lock setting was enabled from Dante Controller, disable the setting, or check the device setting DIP switch positions, and set them to accommodate the current situation.

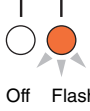

Warnings

The indicators will light and/or flash as shown until the cause is resolved.
If the green [SYNC] is unlit, the unit's clock is unconfirmed.

[SYNC]	Description	Possible Solution
 <p>Off Flashing</p>	Clock settings are incorrect.	Check the clock leader and sampling frequency settings of the Tio1608-D2 and Dante Controller.
 <p>Off Flashes 2 times</p>	Unit not connected to Dante network.	Make sure the cables are not damaged and that they are connected properly.
 <p>Off Flashes 3 times</p>	Cable wiring is wrong; cannot find other Dante devices.	Check the wiring of the Ethernet cables.

If the green indicator is flashing, the unit is the clock leader.

If the green indicator is lit, the unit is the clock follower and the clock is synchronized.



[SYNC]	Description	Possible Solution
 <p>Lit or flashing Lit</p>	Device that is not Gigabit Ethernet compatible is connected.	To use Dante to send and receive digital audio, make sure your devices are Gigabit Ethernet compatible.
 <p>Lit or flashing Flashing</p>	When using a redundancy network, [SECONDARY] is sending/receiving audio.	Check the connections of the network connected to the [PRIMARY].
 <p>Lit or flashing Flashes 2 times</p>	When using a redundancy network, error was detected on the [SECONDARY].	Check the connections of the network connected to the [SECONDARY].

Information Message

The indicators will remain lit and/or flashing cyclically to report the status.

If the orange [SYNC] is unlit, the unit is operating normally.

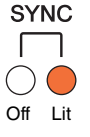
If the green [SYNC] is unlit, the unit's clock is unconfirmed.

[SYNC]	Description	Possible Solution
 <p>Off Lit</p>	Synchronizing on a Dante network.	Please wait until started has completed or until the unit has finished synchronization. It may take up to 45 seconds for completion.
	Waiting to receive setting data.	If START UP MODE is set to REFRESH on the Tio1608-D2 unit, the input/output will be muted until the unit receives setting data after it starts up.
 <p>Flashing Off</p>	The unit is functioning correctly as the word clock leader.	The unit is operating as the word clock leader.
 <p>Lit Off</p>	The unit is functioning correctly as the word clock follower.	The unit is operating as the clock follower and the clock is synchronized.

General Specifications

Output impedance of signal generator: 150 ohms

Measured with another Tio1608-D2 through Dante network.

Frequency Response

Fs = 20Hz-20kHz, refer to the nominal output level @1kHz

Input	Output	RL	Conditions	Min.	Typ.	Max.	Unit
INPUT1-16	OUTPUT 1-8	600Ω	GAIN: +66dB.	-1.5	0.0	0.5	dB

Total Harmonic Distortion

Fs = 44.1kHz or 48kHz

Input	Output	RL	Conditions	Min.	Typ.	Max.	Unit
INPUT1-16	OUTPUT 1-8	600Ω	+4dBu@20Hz-20kHz, GAIN: +66dB.			0.1	%
		600Ω	+4dBu@20Hz-20kHz, GAIN: -6dB.			0.05	%

Fs = 88.2kHz or 96kHz

Input	Output	RL	Conditions	Min.	Typ.	Max.	Unit
INPUT1-16	OUTPUT 1-8	600Ω	+4dBu@20Hz-20kHz, GAIN: +66dB.			0.2	%
		600Ω	+4dBu@20Hz-20kHz, GAIN: -6dB.			0.05	%

* Total Harmonic Distortion is measured with a -18dB/octave filter @80kHz

Hum & Noise

Fs = 48kHz, EIN: Equivalent Input Noise

Input	Output	RL	Conditions	Min.	Typ.	Max.	Unit
INPUT1-16	OUTPUT 1-8	600Ω	Rs=150Ω, GAIN: +66dB.		-128		dBu
					EIN		
					-62		dBu
		600Ω	Rs=150Ω, GAIN: -6dB.		-84	-80	dBu
all Inputs	OUTPUT 1-8	600Ω	Rs=150Ω, GAINs: -6dB.			-70	dBu
-	OUTPUT 1-8	600Ω	Residual output noise		-88		dBu

Fs = 96kHz, EIN: Equivalent Input Noise

Input	Output	RL	Conditions	Min.	Typ.	Max.	Unit
INPUT1-16	OUTPUT 1-8	600Ω	Rs=150Ω, GAIN: +66dB.		-128		dBu
					EIN		
					-62		dBu
		600Ω	Rs=150Ω, GAIN: -6dB.		-84	-80	dBu
all Inputs	OUTPUT 1-8	600Ω	Rs=150Ω, GAINs: -6dB.			-70	dBu
-	OUTPUT 1-8	600Ω	Residual output noise		-86		dBu

* Hum & Noise are measured with A-weighting filter.

Dynamic Range

Fs = 48kHz

Input	Output	RL	Conditions	Min.	Typ.	Max.	Unit
INPUT1-16	OUTPUT 1-8	600Ω	AD + DA, GAIN: -6dB.		108		dB
-	OUTPUT 1-8	600Ω	DA Converter		112		dB

Fs = 96kHz

Input	Output	RL	Conditions	Min.	Typ.	Max.	Unit
INPUT1-16	OUTPUT 1-8	600Ω	AD + DA, GAIN: -6dB.		108		dB
-	OUTPUT 1-8	600Ω	DA Converter		110		dB

* Dynamic Range are measured with A-weighting filter.

Crosstalk@1kHz

from/to	to/from	Conditions	Min.	Typ.	Max.	Unit
INPUT n	INPUT (n-1) or (n+1)	INPUT1-16 adjacent inputs, GAIN: -6dB.			-100	dB
OUTPUT n	OUTPUT (n-1) or (n+1)	OUTPUT 1-8, input to output			-100	dB

* Crosstalk is measured with a -30dB/octave filter @22kHz

Sampling Frequency

		Conditions	Min.	Typ.	Max.	Unit
External Clock	Frequency Range	44.1kHz / 48kHz / 88.2kHz / 96kHz	-200		+200	ppm
		+4.1667%/+0.1%/-0.1%/-4.0% to all of the above	-200		+200	ppm

Power Requirements

	Conditions	Min.	Typ.	Max.	Unit
Power Requirements	100-240V 50/60Hz			50	W
Heat Dissipation	100-240V 50/60Hz			43.5	kcal/h

AC Cable Length and Temperature Range

	Conditions	Min.	Typ.	Max.	Unit
AC Cable Length			2.5		m
Temperature Range	Operating temperature range	0		40	°C
	Storage temperature range	-20		60	°C

Dimensions (W x H x D) & Net weight

480(W) x 88(H) x 364(D) mm, 5.7kg

Input Output Digital I/O Character

Analog input characteristics

Input Terminals	GAIN	Actual Load Impedance	For Use With Nominal	Input Level			Connector	balanced / Unbalanced
				Sensitivity*1	Nominal	Max. before clip		
INPUT1-16	+66dB	7.5k Ω	50-600 Ω Mics or 600 Ω Lines	-82dBu (61.6 μ V)	-62dBu (0.616mV)	-42dBu (6.16mV)	Combo (XLR 3-hole chassis*2 or TRS phone*3)	Balanced
	-6dB			-10dBu (245mV)	+10dBu (2.45V)	+30dBu (24.5V)		

In these specifications, 0dBu = 0.775Vrms.

+48V DC (phantom power) can be supplied to INPUT XLR type connectors via each individual software controlled switch.

- *1. Sensitivity is the lowest level that will produce an output of +4dBu (1.23V) or the nominal output level when the unit is set to maximum gain.
- *2. 1: GND, 2: HOT, 3: COLD
- *3. Tip: HOT, Ring: COLD, Sleeve: GND

Analog output characteristics

Output Terminals	Actual Source Impedance	For Use With Nominal	Output Level		Connector	balanced / Unbalanced
			Nominal	Max. before clip		
OUTPUT 1-8	75 Ω	600 Ω Lines	+4dBu (1.23 V)	+24dBu (12.3 V)	XLR 3-pin chassis*1	Balanced

In these specifications, 0dBu = 0.775Vrms.

- *1. 1: GND, 2: HOT, 3: COLD

Digital input/output specifications

Terminal	Format	Data length	Level	Audio	Connector
Primary / Secondary	Dante	24 or 32bit	1000BASE-T	16ch (Tio1608-D2 to other devices) 8ch (Other devices to Tio1608-D2)	etherCON Cat5e

- * 本書は、発行時点での最新仕様で説明しています。最新版は、ヤマハウェブサイトからダウンロードできます。
- * The contents of this manual apply to the latest specifications as of the publishing date. To obtain the latest manual, access the Yamaha website then download the manual file.
- * Der Inhalt dieser Bedienungsanleitung gilt für die neuesten technischen Daten zum Zeitpunkt der Veröffentlichung. Um die neueste Version der Anleitung zu erhalten, rufen Sie die Website von Yamaha auf und laden Sie dann die Datei mit der Bedienungsanleitung herunter.
- * Le contenu de ce mode d'emploi s'applique aux dernières caractéristiques techniques connues à la date de publication du manuel. Pour obtenir la version la plus récente du manuel, accédez au site Web de Yamaha puis téléchargez le fichier du manuel concerné.
- * El contenido de este manual se aplica a las últimas especificaciones según la fecha de publicación. Para obtener el último manual, acceda al sitio web de Yamaha y descargue el archivo del manual.
- * O conteúdo deste manual se aplica às especificações mais recentes a partir da data de publicação. Para obter o manual mais recente, acesse o site da Yamaha e faça o download do arquivo do manual.
- * Il contenuto del presente manuale si applica alle ultime specifiche tecniche a partire dalla data di pubblicazione. Per ottenere la versione più recente del manuale, accedere al sito Web Yamaha e scaricare il file corrispondente.
- * В содержании данного руководства приведены последние на момент публикации технические характеристики. Для получения последней версии руководства посетите веб-сайт корпорации Yamaha и загрузите файл с руководством.

Dimensions

Tio1608-D2

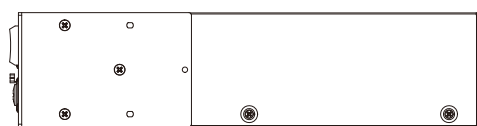
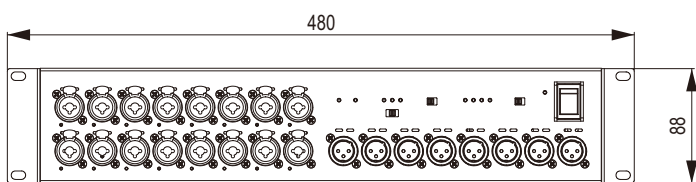
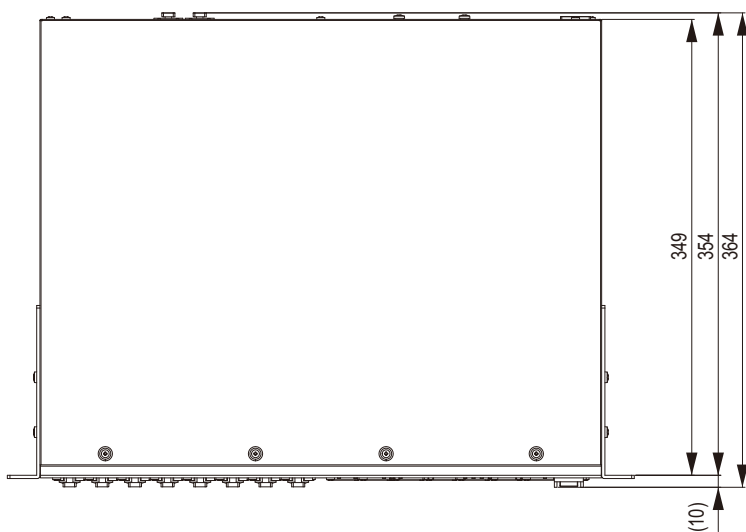

Unit: mm

English

Deutsch

Français

Español

Português

Italiano

Русский

日本語

MEMO

Yamaha Worldwide Representative Offices

English

For details on the product(s), contact your nearest Yamaha representative or the authorized distributor, found by accessing the QR code below.

Deutsch

Wenden Sie sich für nähere Informationen zu Produkten an einen Yamaha-Vertreter oder autorisierten Händler in Ihrer Nähe. Diese finden Sie mithilfe des QR-Codes unten.

Français

Pour obtenir des informations sur le ou les produits, contactez votre représentant ou revendeur agréé Yamaha le plus proche. Vous le trouverez à l'aide du QR code ci-dessous.

Español

Para ver información detallada sobre el producto, contacte con su representante o distribuidor autorizado Yamaha más cercano. Lo encontrará escaneando el siguiente código QR.

Italiano

Per dettagli sui prodotti, contattare il rappresentante Yamaha o il distributore autorizzato più vicino, che è possibile trovare tramite il codice a matrice in basso.

Português

Para mais informações sobre o(s) produto(s), fale com seu representante da Yamaha mais próximo ou com o distribuidor autorizado acessando o código QR abaixo.

Русский

Чтобы узнать подробнее о продукте (продуктах), свяжитесь с ближайшим представителем или авторизованным дистрибьютором Yamaha, воспользовавшись QR-кодом ниже.

简体中文

如需有关产品的详细信息，请联系距您最近的Yamaha代表或授权经销商，可通过访问下方的二维码找到这些代表或经销商的信息。

繁體中文

如需產品的詳細資訊，請聯絡與您距離最近的 Yamaha 銷售代表或授權經銷商，您可以掃描下方的 QR 碼查看相關聯絡資料。

한국어

제품에 대한 자세한 정보는 아래 QR 코드에 액세스하여 가까운 Yamaha 담당 판매점 또는 공식 대리점에 문의하십시오.



https://manual.yamaha.com/pa/address_list/

Head Office/Manufacturer: Yamaha Corporation 10-1, Nakazawa-cho, Naka-ku, Hamamatsu, 430-8650, Japan

Importer (European Union): Yamaha Music Europe GmbH Siemensstrasse 22-34, 25462 Rellingen, Germany

Importer (United Kingdom): Yamaha Music Europe GmbH (UK) Sherbourne Drive, Tilbrook, Milton Keynes, MK7 8BL, United Kingdom

PA60

YAMAHA CORPORATION

10-1 Nakazawa-cho, Naka-ku, Hamamatsu, 430-8650 Japan

ヤマハ株式会社

〒430-8650 静岡県浜松市中区中沢町10-1

Yamaha Pro Audio global website
<https://www.yamahaproaudio.com/>
Yamaha Downloads
<https://download.yamaha.com/>

© 2023 Yamaha Corporation

Published 06/2023
LBES-B0



VGN2400