

# YAMAHA RX-900U *RS*

*Natural Sound AM/FM Stereo Receiver*

*RS Integrated System Remote Control Capability*

*Video Enhancer for Dubbing & Monitor with 3 Video Input Selectors*

*Audio and Video Rec-Out Selectors*

*Simulated Stereo and Dynamic Noise Canceller*

*Absolute Linear Amplification (ALA)*

*Computer Servo Lock Tuning with Digital Fine Tuning*

*High Dynamic Power, Low Impedance Drive Capability*

*Banana-Plug Compatible 2 Speaker Terminals*

*Thank you for purchasing the YAMAHA RX-900U stereo receiver.*

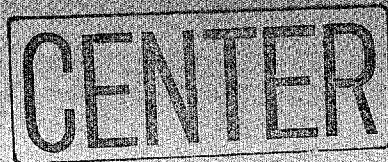

OWNER'S MANUAL



## CONTENTS

Safety Instructions .....	1
Caution .....	2
Control Parts and Their Functions .....	3
Supplied Accessories .....	6
Using the Remote Control Transmitter .....	10
Connections .....	11
Operations .....	15
Technical Information .....	18
Troubleshooting .....	19
Specifications .....	20

### IMPORTANT!

Please record the serial number of your unit in the space below.

Model: **RX-900U**

Serial No.:

The serial number is located on the rear of the unit.  
Retain this Owner's Manual in a safe place for future reference.

### WARNING

To prevent fire or shock hazard, do not expose this appliance to rain or moisture.

# RX-900U

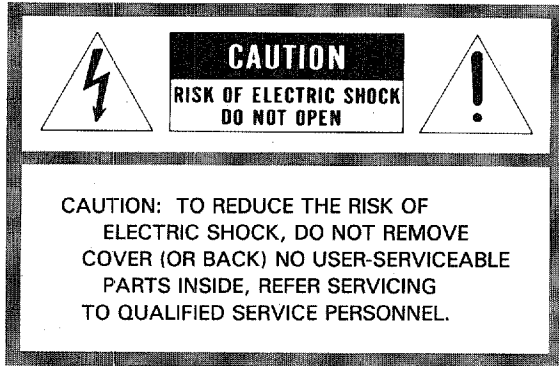

## • Explanation of Graphical Symbols



The lightning flash with arrowhead symbol, within an equilateral triangle, is intended to alert you to the presence of uninsulated "dangerous voltage" within the product's enclosure that may be of sufficient magnitude to constitute a risk of electric shock to persons.



The exclamation point within an equilateral triangle is intended to alert you to the presence of important operating and maintenance (servicing) instructions in the literature accompanying the appliance.

## SAFETY INSTRUCTIONS

- 1 Read Instructions – All the safety and operating instructions should be read before the appliance is operated.
- 2 Retain Instructions – The safety and operating instructions should be retained for future reference.
- 3 Heed Warnings – All warnings on the appliance and in the operating instructions should be adhered to.
- 4 Follow Instructions – All operating and other instructions should be followed.
- 5 Water and Moisture – The appliance should not be used near water – for example, near a bathtub, washbowl, kitchen sink, laundry tub, in a wet basement, or near a swimming pool, etc.
- 6 Carts and Stands – The appliance should be used only with a cart or stand is recommended by the manufacturer.
- 7 Wall or Ceiling Mounting – The appliance should be mounted to a wall or ceiling only as recommended by the manufacturer.
- 8 Ventilation – The appliance should be situated so that its location or position does not interfere with its proper ventilation. For example, the appliance should not be situated on a bed, sofa, rug, or similar surface that may block the ventilation openings; or placed in a built-in installation, such as a bookcase or cabinet that may impede the flow of air through the ventilation openings.
- 9 Heat – The appliance should be situated away from heat sources such as radiators, or other appliances that produce heat.
- 10 Power Sources – The appliance should be connected to a power supply only of the type described in the operating instructions or as marked on the appliance.
- 11 Power-Cord Protection – Power-supply cords should be routed so that they are not likely to be walked on or pinched by items placed upon or against them, paying particular attention to cords at plugs, convenience receptacles, and the point where they exit from the appliance.
- 12 Cleaning – The appliance should be cleaned only as recommended by the manufacturer.
- 13 Nonuse Periods – The power cord of the appliance should be unplugged from the outlet when left unused for a long period of time.
- 14 Object and Liquid Entry – Care should be taken so that objects do not fall into and liquids not spilled into the inside of the appliance.
- 15 Damage Requiring Service – The appliance should be serviced by qualified service personnel when:
  - A. The power-supply cord or the plug has been damaged; or
  - B. Objects have fallen, or liquid has been spilled into the appliance; or
  - C. The appliance has been exposed to rain; or
  - D. The appliance does not appear to operate normally or exhibits a marked change in performance; or
  - E. The appliance has been dropped, or the cabinet damaged.

# RX-900U

**CAUTION: READ THIS BEFORE OPERATING YOUR RX-900U**

**16** Servicing – The user should not attempt to service the appliance beyond those means described in the operating instructions. All other servicing should be referred to qualified service personnel.

**17** Power Lines – An outdoor antenna should be located away from power lines.

**18** Grounding or Polarization – The precautions that should be taken so that the grounding or polarization means of an appliance is not defeated.

**19** Outdoor Antenna Grounding – If an outside antenna is connected to the receiver, be sure the antenna system is grounded so as to provide some protection against voltage surges and built up static charges.

Section 810 of the National Electrical Code, ANSI/NFPA No. 70-1984, provides information with respect to proper grounding of the mast and supporting structure, grounding of the lead-in wire to an antenna discharge unit, size of grounding conductors, location of antenna-discharge unit, connection to grounding electrodes, and requirements for the grounding electrode.

1. The RX-900U is a sophisticated receiver. To ensure proper operation for the best possible performance, please read this manual carefully.
2. Choose the installation location of your RX-900U carefully. Avoid placing it in direct sunlight or close to a source of heat. Also avoid locations subject to vibration and excessive dust, heat, cold or moisture. Keep it away from such sources of hum as transformers or motors.
3. Do not open the cabinet as this might result in damage to the set, or electrical shock. If a foreign object should get into the set, contact your dealer.
4. To prevent lightning damage, pull out the power cord and remove the antenna cable during an electrical storm.
5. When removing the power plug from the wall outlet, always pull directly on the plug; never pull the cord itself.
6. Do not use force when using the switches.
7. When moving the set be sure to first pull out the power plug and remove cords connected to other equipment.
8. Do not attempt to clean the RX-900U with chemical solvent as this might damage the finish. Use a clean, dry cloth.
9. Be sure to read the "Troubleshooting" section for advice on common operating errors before concluding that your RX-900U is faulty.
10. Keep this manual in a safe place for future reference.

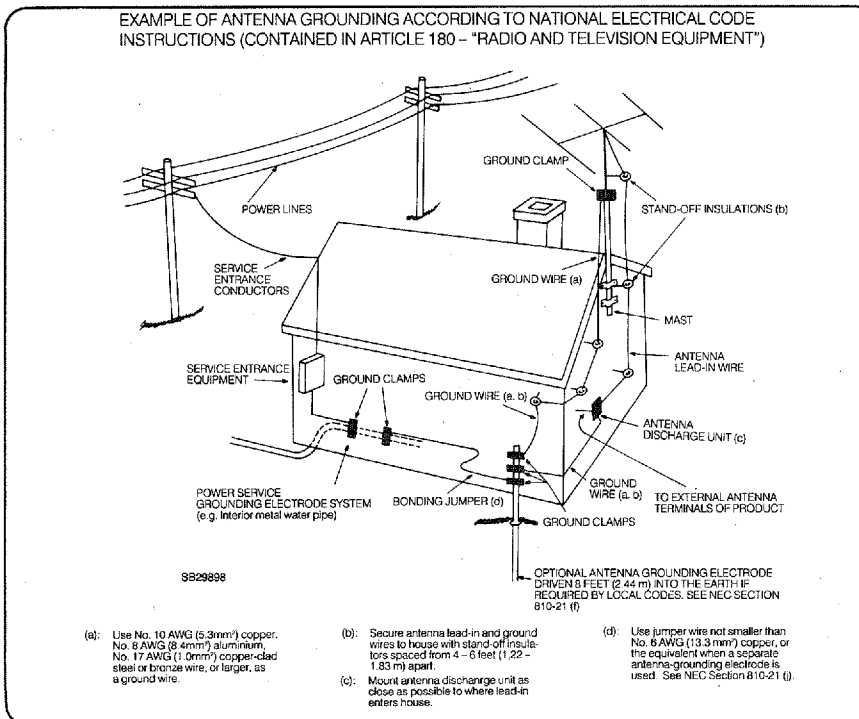

# RX-900U

## CONTROL PARTS AND THEIR FUNCTIONS

### FRONT PANEL

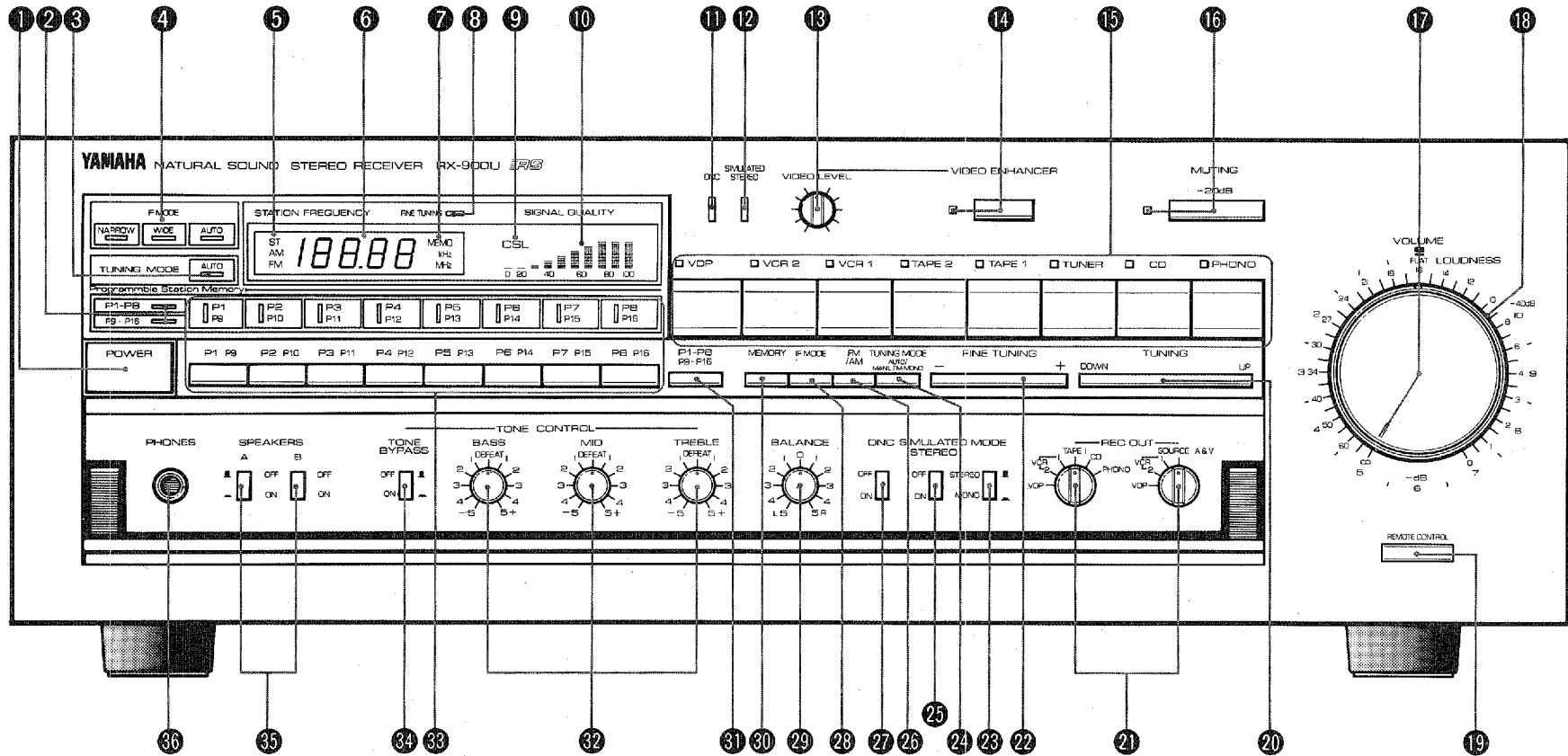

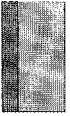

## Amplifier section

### ① POWER switch

Press this switch to turn the power on. Press the switch again to turn the power off.

### ⑪ DNC (dynamic noise canceller) indicator

Lights when the DNC switch ⑳ is set to ON.

### ⑫ SIMULATED STEREO indicator

Lights when the SIMULATED STEREO switch ㉕ is set to ON.

### ⑮ Input selectors and indicators

Used to select the program source to be heard.

### ⑯ MUTE button and indicator

Press this button to mute the sound level by 20 dB. Press the button again to resume original sound level.

This button is very convenient for lowering the volume level temporarily (for instance, to answer a phone call) without disturbing the original volume level setting.

### ⑰ VOLUME control and indicator

This control is used to and indicator raise or lower the output volume level.

### ⑱ Continuous variable LOUDNESS control

This control allows you to retain full tonal range at any volume levels. Your ear loses sensitivity to high and low frequency ranges at low volume settings. This control provides an equalization curve based on human hearing.

To adjust the LOUDNESS control to your listening level, first, set the control to the FLAT position, increase the VOLUME control to your loudest listening level, then turn the LOUDNESS control counterclockwise to reduce the volume level.

### ⑲ REMOTE CONTROL sensor

This is used to receive signals from the remote control transmitter.

### ㉑ REC OUT selectors VIDEO REC OUT selector

Use this selector to select the video source to be recorded. At SOURCE A & V position, the video and/or audio source selected with the input selectors ⑮ is selected.

### AUDIO REC OUT selector

Use this selector to select the audio source to be recorded.

### ㉒ FM/AM button

Press this button to select the reception band between FM and AM.

### ㉓ DNC switch

When this switch is set to ON, the Dynamic Noise Canceller, an exclusive YAMAHA noise reduction system functions to increase the S/N (signal-to-noise ratio) of any source.

### ㉔ BALANCE control

Use this control to concurrently change the left and right output volume to the speaker terminals to compensate for sound imbalance caused from speaker settings or listening room condition.

### ㉕ Tone controls

#### BASS

Used to increase or decrease the low frequency response. The DEFEAT position produces flat response.

#### MID

Used to increase or decrease the high frequency response. The DEFEAT position produces flat response.

#### TREBLE

Used to increase or decrease the high frequency response. The DEFEAT position produces flat response.

### ㉖ TONE BYPASS switch

When this switch is set to ON, the input signal does not pass through the tone control circuitry so that it is unaffected by the tone control circuitry.

Use this switch to obtain pure sound and to check the tone control setting.

Set this switch to OFF to activate the tone control circuitry.

# RX-900U

## ③⑤ **SPEAKERS selectors**

Used to select the speaker system to be used.

## ③⑥ **PHONES jack**

Plug in the headphones to this jack. To shut off the sound from the speakers, set the SPEAKERS selectors to OFF.

## **Tuner section**

### ② **P1-P8/P9-P16 indicator**

Indicates the range of the preset station buttons.

### ③ **AUTO indicator**

Lights when the TUNING MODE button ⑳ is set to AUTO.

### ④ **IF MODE indicators**

#### **AUTO indicator**

This indicator lights when the auto IF mode is selected with the IF MODE button ⑳.

#### **WIDE and NARROW indicators**

These indicators show the IF MODE selected with the IF MODE button or in the auto IF mode.

### ⑤ **ST (stereo) indicator**

Lights when an FM stereo broadcasting with a sufficient signal strength is received with the TUNING MODE button set to AUTO.

### ⑥ **STATION FREQUENCY display**

Displays the band and frequency of the received frequency.

### ⑦ **MEMO (memory) indicator**

Flickers for about 5 seconds when the MEMORY button ⑳ is pressed.

### ⑧ **FINE TUNING indicator**

This indicator lights when the FINE TUNING button ㉓ is operated.

### ⑨ **CSL (computer servo lock) indicator**

This indicator lights when a broadcasting signal with a sufficient level is locked with YAMAHA CSL system. A station signal is initially tuned in with a PLL tuning synthesizer tuning circuit. When the signal received is a strong, high-quality signal, the CSL system selects the FM servo tuning circuit to maximize reproduction quality.

### ⑩ **SIGNAL QUALITY indicator**

Indicates the level of the received frequency. If the multipath interference is detected, the level of the signal quality indication decreases.

### ⑳ **TUNING button**

Press either side of the TUNING button to carry out auto or manual tuning.

### ㉓ **FINE TUNING button**

Press either side of the FINE TUNING button to tune in the station precisely. When this button is pressed, the displayed frequency changes by 0.01 MHz in FM and 1 kHz in AM band.

### ㉔ **MODE switch**

Used to select the monaural or stereo mode.

### ㉕ **TUNING MODE button**

Used to select the tuning mode between AUTO and MAN'L FM MONO. In the MAN'L FM MONO mode, an FM stereo broadcasting is received in monaural.

### ㉖ **SIMULATED STEREO switch**

When this switch is set to ON, depth and imaging of a monaural audio source, such as video and TV sound, are increased.

### ㉗ **IF MODE button**

Use this button to select auto IF mode, NARROW or WIDE IF mode. When the auto IF mode is selected with this button, the optimum IF mode is selected automatically. When the reception signal is strong, press this button so that the WIDE indicator lights up to obtain the distortion-free sound. When the reception signal is weak or when the desired station is interfered with adjacent stations, press this button so that the NARROW indicator lights up to increase the selectivity.

## SUPPLIED ACCESSORIES

After unpacking, check that the following parts are contained.

### 30 MEMORY button

When this button is pressed, the MEMO indicator flickers in the display for about 5 seconds. During this period, press the desired preset station button to store the displayed frequency.

### 31 P1-P8/P9-P16 button

Press this button to change the range of preset station buttons. When this button is pressed, the selected range of the P1-P8/P9-P16 indicators flickers for about 5 seconds.

### 33 Preset station buttons and indicators

Up to 16 station frequencies and reception modes can be stored using the preset station button. The indicator above the selected preset station button lights.

## Video section

### 13 VIDEO LEVEL control

This control is used to increase or decrease the overall level of the enhanced video signal with the VIDEO ENHANCER button 14 set to ON. Normally, set this control to center click position.

### 14 VIDEO ENHANCER button and indicator

Press this button to operate the VIDEO LEVEL control.

To activate VIDEO LEVEL control for video recording, be sure to set the VIDEO REC OUT selector to SOURCE A & V position and select the video program to be recorded with the input selector key.

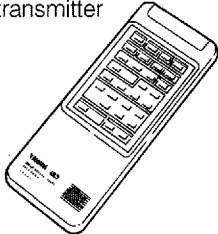
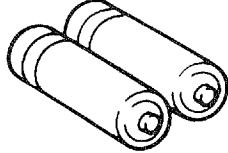
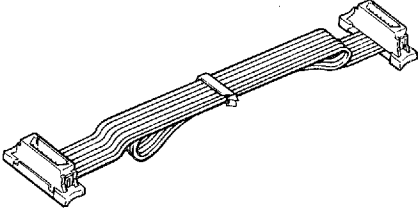
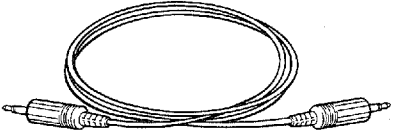
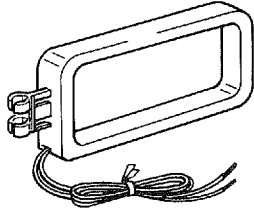
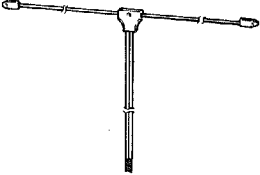
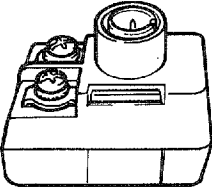
<p>Remote control transmitter</p> 	<p>Batteries (size "AA", R06)</p> 
<p>Remote control cable (6-pin, cassette deck)</p> 	<p>Remote control cable (mini-plug, turntable)</p> 
<p>AM loop antenna</p> 	<p>Indoor FM antenna</p> 
<p>75-ohm/300-ohm Antenna Adapter</p> 	

# RX-900U

## REAR PANEL

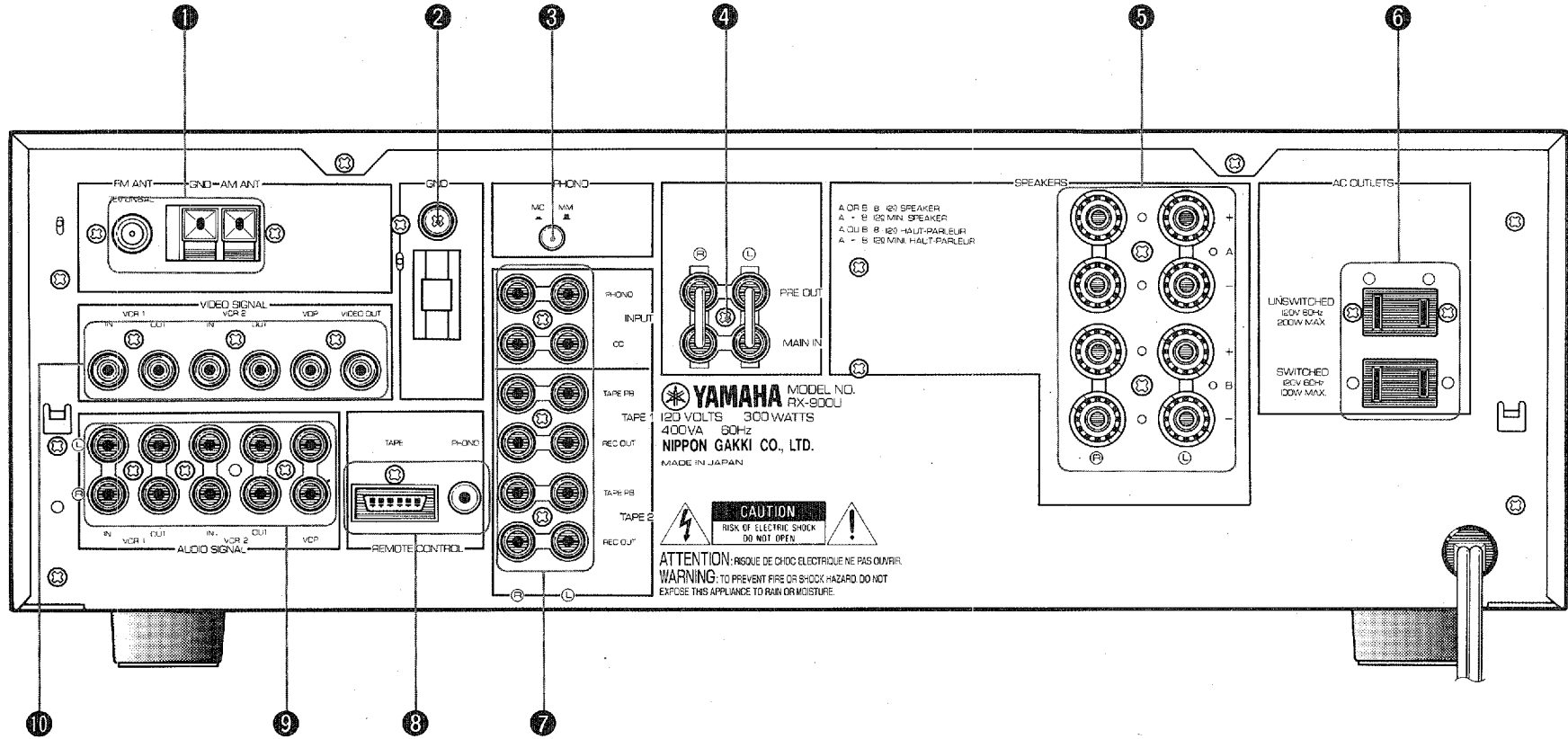



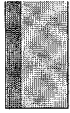

## ① Antenna terminals

Connect an FM and AM antennas to these terminals.

## ② GND terminal

Connect the ground wire of a turntable.

## ③ PHONO selector

Set this selector according to the type of the cartridge, MM (moving magnet) or MC (moving coil) used in your turntable.

## ④ PRE OUT/MAIN IN jacks

For extra system flexibility, this unit allows you to connect a signal processing system, such as a graphic equalizer or sound processor. For connection of each unit, refer to the Owner's Manual attached to the unit to be connected.

## ⑤ SPEAKERS terminals

Two pairs of speakers A and B can be connected to these terminals.

## ⑥ AC OUTLETS

Use these to connect the power cords from your components to the receiver. The power to the SWITCHED outlets is controlled by the receiver's POWER switch or remote control transmitter's POWER key. They will supply power to any component whenever this unit is turned on.

The power to the UNSWITCHED outlet is not controlled by the receiver. It will continually supply power to any unit connected. The maximum power (total power consumption of components) that can be connected to the UNSWITCHED AC OUTLET is 200 watts and to the SWITCHED AC OUTLET is 100 watts.

## ⑦ Audio signal connection jacks

### PHONO

Connect a turntable.

### CD

Connect a compact disc player.

### TAPE 1

Connect a first tape deck.

### TAPE 2

Connect a second tape deck.

## ⑧ REMOTE CONTROL connectors

Use these to connect compatible YAMAHA components (with an *ERS* mark) to your receiver for remote control of each component.

### PHONO

Connect to a turntable using the cable with a mini-plug connectors.

### TAPE 1/2

Connect to a cassette tape deck using the cable with 6-pin connector.

## ⑨ Video unit AUDIO SIGNAL connection jacks

Use these to connect the audio signal cords from your components to the receiver. They should be connected to the proper input/output jacks for each unit. Be sure that L and R channels are connected consistently.

### VDP

Connect an audio signal of the video disc player.

### VCR 1/2

Connect an audio signal of the video cassette recorder for both recording and playback.

## ⑩ VIDEO SIGNAL jacks

Use these to connect the video signal cords from your components to the receiver. They should be connected to the proper input/output jacks for each unit.

### VCR 1/2

Connect a video recorder for both recording and playback.

### VDP

Connect a video disc player.

### VIDEO OUT

Connect a monitor TV.

# RX-900U

REMOTE CONTROL TRANSMITTER

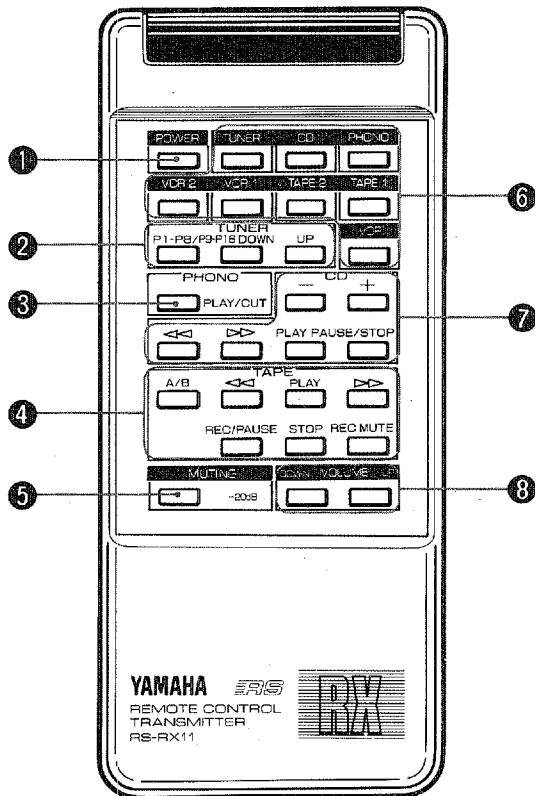

## 1 POWER key

Press this key to turn the power of receiver ON and OFF.

## 2 Tuner section

These keys are used to select the broadcast station preset.

### UP

Press to select the preset station. Each time this key is pressed, the preset number is increased by one. (Ex: P7 → P8) When the key is pressed during the P8 (P16) station is received, the preset number will be changed to P1 (P9).

### DOWN

Press to select the preset station. Each time this key is pressed, the preset number is decreased by one. (Ex: P8 → P7) When the key is pressed during the P1 (P9) station is received, the preset number will be changed to P8 (P16).

### P1-P8/P9-P16

Each time this key is pressed, the preset station range is changed between P1-P8 and P9-P16 alternately.

## 3 Turntable section

This key is used to start and stop record play on the turntable with *RS* mark connected to this unit. This key functions same as the PLAY/CUT key on the turntable. Pressing this key starts record play and pressing it again stops playing.

## 4 Tape deck section

These keys are used to operate the cassette deck with *RS* mark connected to this unit.

### A-B

Press to select the deck to be operated between the deck A and B on the double cassette deck.



Press to rewind the tape.

### PLAY

Press to start tape play. When the double cassette deck is used, pressing the key starts tape play on the last playing deck.



Press to fast forward the tape.

### REC/PAUSE

Press to set to recording pause mode.

### STOP

Press to stop the tape.

### REC MUTE

Press to make the non-recorded section during recording.

## 5 MUTE key

Press this key to mute the sound level by about -20dB. Press the key again to resume original sound level.

## 6 Input selector keys

Select the desired programs source with these keys.

## 7 CD player section

The CD player with *RS* mark can be controlled directly with the remote control transmitter.



Press to advance to the beginning of the next tune.



Press to return to the beginning of the current tune. When this key is pressed at the beginning of the tune, the play will start at the beginning of the previous tune.

# RX-900U

## PAUSE/STOP

Used to set the player to pause or stop mode. Pressing the key once to stop play temporarily and pressing it again stops play.

## PLAY

Press this key to start play.



Press to fast forward the tune.



Press to fast rewind the tune.

## 8 VOLUME control keys

These keys are used to adjust the volume level heard from the headphones jack or the speakers connected to this unit.

## USING THE REMOTE CONTROL TRANSMITTER

The remote control transmitter supplied with your receiver is designed to control all the most commonly used features of the receiver. If the CD player, turntable and cassette deck connected to your receiver are YAMAHA components designed for remote control compatibility (components with an *RS* mark), then this remote control transmitter will also control various functions of each component. Please consult your YAMAHA dealer for information on which components are compatible with the remote control transmitter. Note that this Remote Control will directly operate any compatible YAMAHA CD player.

## BATTERY INSTALLATION

The remote control unit uses 2 batteries (size "AA", R06). Install them according to the following illustration. Be sure that they are installed correctly.

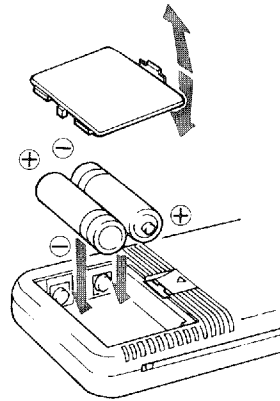

## OPERATION RANGE

You must point the remote control unit toward the receiver and be within about 7 meters (23 feet) of it for proper operation.

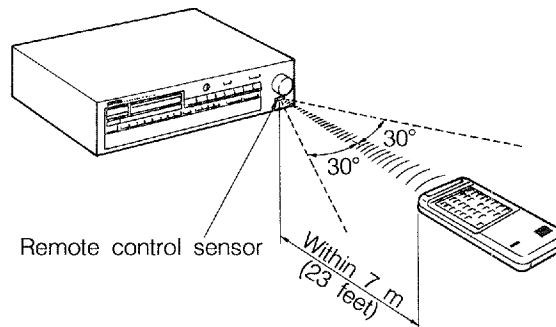

## BATTERY REPLACEMENT

When the remote controllable distance becomes short, batteries are exhausted. Replace two batteries with new ones.

### Battery cautions

Incorrect use of the battery may cause leakage or explosion. Be careful the following items:

#### When replacing:

- Place the batteries in correct (+) and (-) polarities as indicated in the battery compartment.
- Do not use the old battery together with new one.
- Do not use the different kind of batteries at the same time even though in the same shape.

#### Rechargeable batteries:

- There are two kinds of batteries in the market; rechargeable and non-rechargeable. Read the caution labels on the battery carefully.

#### Use with the remote control transmitter:

- When not in use for an extended period of time, remove the batteries from the remote control transmitter.
- Replace the exhausted batteries earlier in good time.

#### To prevent accident:

- Never disassemble, heat the battery, or throw into the fire. Dispose the batteries in the specified places.
- Do not connect (short) (+) and (-) directly with the metal piece, etc.

#### In case of leakage:

Wipe off the electrolyte in the battery compartment completely before replace with the new batteries.

# RX-900U

## CONNECTIONS

### Antenna connections

Supplied indoor FM antenna

Outdoor FM antenna

Outdoor AM antenna

Ground

Supplied AM loop antenna

Supplied 75-ohm/300-ohm antenna adapter

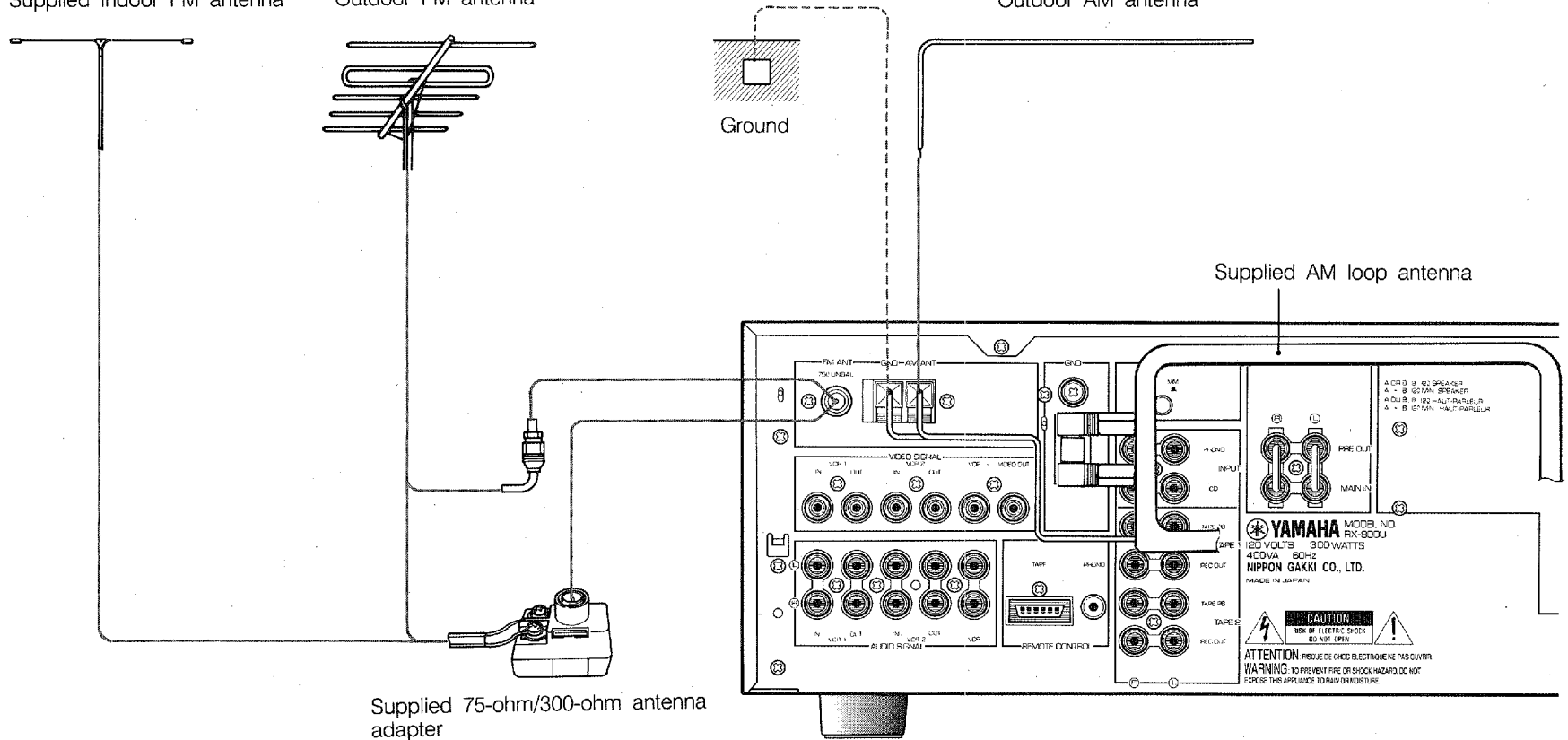

A C/D 8 Ω SPEAKER  
A - B 8 Ω 4W SPEAKER  
A C/D B 16 Ω 4W PARALLEL  
A - B 8 Ω 4W PARALLEL

YAMAHA MODEL NO. RX-900U  
120 VOLTS 300 WATTS  
400VA 50/60 HZ  
NIPPON GAKKI CO., LTD.  
MADE IN JAPAN

**CAUTION**  
RISK OF ELECTRIC SHOCK  
DO NOT OPEN

**ATTENTION** RISK OF OVERHEATING FROM OVERPOWER  
**WARNING** TO PREVENT FIRE OR SHOCK HAZARD DO NOT EXPOSE THIS APPLIANCE TO RAIN OR MOISTURE

# RX-900U

## NOTES ON CONNECTIONS

- Be sure to turn off the power to all units before making any connections.
- The power cord and AC outlet have polarity indicators – a minus sign with the cord and sockets of a different size with the AC outlet. The purpose of this is to match polarities. Observe the polarity marks when connecting the AC outlets of receiver and other equipment.

## ANTENNA CONNECTIONS

### ● AM loop antenna

Connect the AM loop antenna cords to the AM ANT and GND terminals.

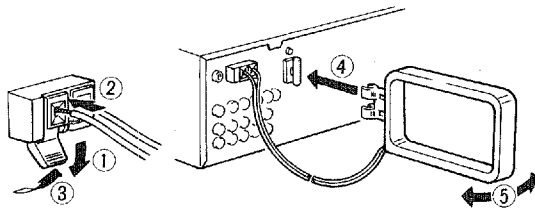

- ① Lower the knobs of the terminals.
- ② Connect the loop antenna cords to the AM ANT and GND terminals.
- ③ Raise the knobs.
- ④ Attach the loop antenna holder to the unit.
- ⑤ Move the AM loop antenna for best reception. The AM loop antenna can be detached from the unit and hung on a wall.

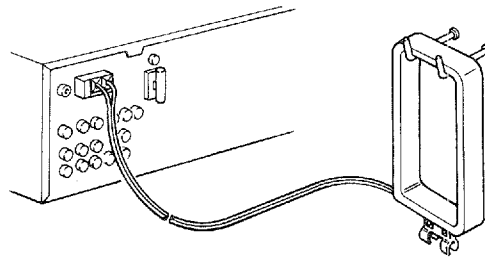

### ● Outdoor AM antenna

The end of the wire should be stripped of insulation and connected to the AM ANT terminal. At this time, keep the loop antenna connected.

### ● Supplied indoor FM antenna

Connect the supplied indoor antenna to the terminals on the supplied 75-ohm/300-ohm antenna adapter. Attach the ring of the antenna adapter to the contacts and connect the antenna adapter to the 75 Ω UNBAL FM ANT terminal.

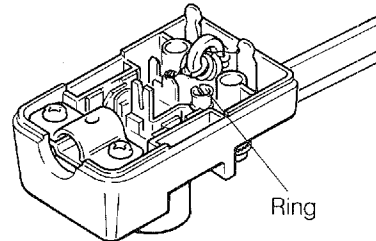

### ● Outdoor FM antenna 75-ohm coaxial cable connection

1. Arrange the end of the coaxial cable.

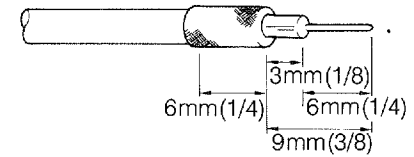

unit : mm (inch)

2. Connect the coaxial cable to the antenna adapter as shown below. Attach the ring of the antenna adapter to the boss in the antenna adapter cover. Connect the antenna adapter to the 75 Ω UNBAL FM ANT terminal.

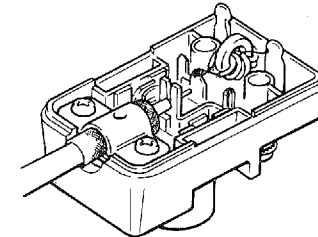

### ● 300-ohm feeder connection

Connect the 300-ohm feeder to the terminals of the supplied 75-ohm/300-ohm antenna adapter, attach the ring of the antenna adapter to the contacts, then insert into the 75 Ω UNBAL FM ANT terminal.

# RX-900U

## AUDIO/VIDEO CONNECTIONS

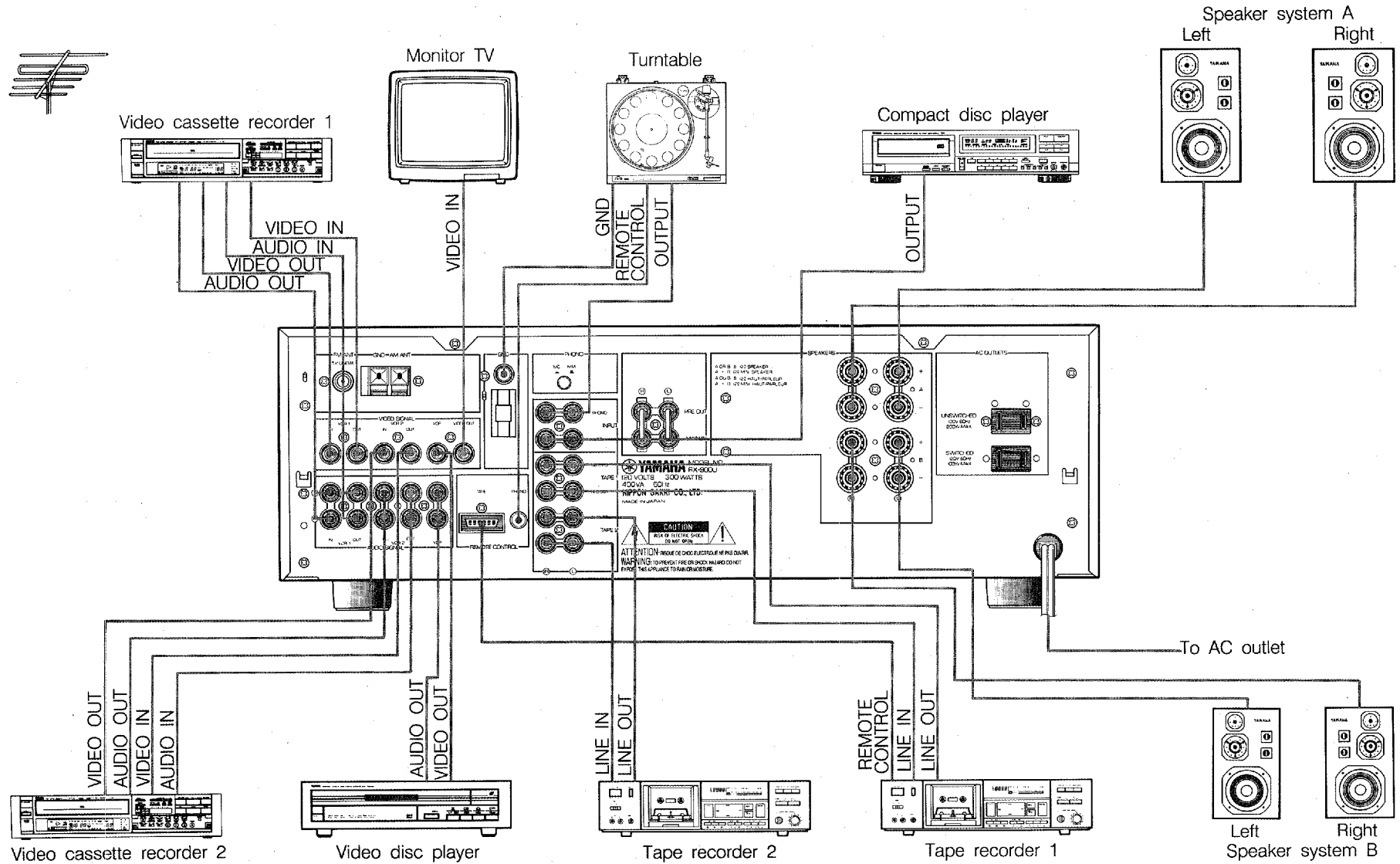



● **Power cord**

Connect the power cord of your receiver to an AC outlet.

● **Speakers**

Connect the SPEAKERS terminals to your speakers with the proper gauge of wire, cut to be as short as possible. Loosen the SPEAKERS terminal knob, insert the bare wires and turn the SPEAKERS terminal counterclockwise. If these connections are faulty, no sound will be heard from the speakers. Make sure that the polarity of the speaker wires is correct, that is, that the + and - markings are observed. If these wires are reversed, the sound will be unnatural and will lack bass. Do not coil up excess speaker wire or bundle the speaker cables with the power cords.

● **Turntable**

Connect the output cords of the turntable to the PHONO jacks, and connect the ground cord to the GND terminal. This should produce minimum hum, but in some cases better results are obtained with this cord disconnected.

● **Compact disc player**

Connect the output jacks of the compact disc player to the CD jacks.

● **Tape deck 1/2**

Connect the cords from a cassette deck to the TAPE 1 or 2 jacks. The playback (LINE OUT) jacks of tape deck go to the TAPE PB jacks of this unit, and the record (LINE IN) jacks of tape deck go to the REC OUT jacks of this unit.

● **VCR 1/2**

Connect the audio jacks of a video cassette recorder to the AUDIO SIGNAL VCR 1 or 2 jacks in. The AUDIO OUT jacks of video cassette recorder go to the AUDIO SIGNAL VCR 1 or 2 IN jacks of this unit and the AUDIO IN jacks of video cassette recorder go to the AUDIO SIGNAL VCR 1 or 2 OUT jacks of this unit.

Connect the video jacks of a video cassette recorder to the VIDEO SIGNAL VCR jacks. The VIDEO OUT jack of video cassette recorder goes to the VIDEO SIGNAL VCR 1 or 2 IN jack of this unit and the VIDEO IN jack of video cassette recorder goes to the VIDEO SIGNAL VCR 1 or 2 OUT jack of this unit.

● **Video disc player**

Connect the video output jack from a video disc player to the VIDEO SIGNAL VDP jack. Connect the audio output jacks from a video disc player to the AUDIO SIGNAL VDP jacks.

● **Monitor TV**

Connect the video jack from a monitor to the VIDEO OUT jack.

● **Other audio component**

For extra system flexibility, this unit allows you to connect a signal processing system, such as graphic equalizer, sound processor, etc., in the signal path prior to the tone control circuitry. To connect these units, pull out the jumper pins from the PRE OUT/MAIN IN jacks, connect the inputs of the unit to the PRE OUT jacks and outputs to the MAIN IN jacks. For details, refer to the Owner's Manual attached to the unit to be connected.

● **Remote control cable**

The REMOTE CONTROL connectors are used when you have YAMAHA compatible components (with an  mark). These connections allow you to control the components from the supplied remote control transmitter.

Connect the remote control cables from the components to the correct connectors on your receiver (i.e. PHONO, TAPE).

Note that no cable is necessary for a compatible CD player as the remote control transmitter operates the player directly.

# RX-900U

## OPERATIONS

### TO LISTEN TO RADIO PROGRAM

#### Auto Tuning

If signals are strong and there is no interference, quick automatic search tuning is possible.

1. Press the TUNER input selector.
2. Select the reception band with FM/AM button.
3. Press the TUNING MODE button so that the AUTO indicator lights up.
4. Select the IF mode with the IF MODE button.
5. Use the TUNING button to tune. The tuning will start automatically and stop at broadcast station frequency with a sufficient signal strength.
6. If the station where tuning stops is not the one you want, press the TUNING button once again.

7. Adjust the VOLUME control, TONE controls, DNC switch.

- When an FM stereo broadcast with a sufficient signal strength is received, the ST indicator lights.
- When the received station is locked with the computer servo lock system, the CSL indicator lights.

#### Manual Tuning

Auto tuning may be impossible if the station signal is weak. If so, use manual tuning.

1. Press the TUNER input selector.
2. Select the reception band with FM/AM button.
3. Press the TUNING MODE button so that the AUTO indicator goes off.
4. Select the AUTO IF mode or NARROW IF mode with the IF MODE button.

5. Use the TUNING button to tune. The frequency will change rapidly if the TUNING button is kept pressed. Release it slightly before reaching the desired frequency, and then press it intermittently until the desired frequency is reached. Use the FINE TUNING button to tune in the station precisely.
6. Adjust the VOLUME control, TONE controls, DNC switch and SIMULATED STEREO switch accordingly.

#### Preset Tuning

The preset station button can be used to select, at a single touch, any desired station which has been preset.

1. Tune to the desired station using auto or manual tuning mode.
2. Select the range of the preset station button with the P1-P8/P9-P16 button.
3. Press the MEMORY button and then while the MEMO indicator is flickering, press the desired preset station button.



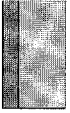

4. To receive the preset station, select the range of the preset station with the P1-P8/P9-P16 button and press the desired preset station button.

- Follow the same procedure for other preset station buttons. The new setting will be programmed in place of the former one.

- The settings of the IF MODE button, TUNING MODE button and FINE TUNING button are also preset.

- **Memory back-up**

The memory back-up circuit will prevent the programmed information from being lost even though the power is switched OFF for timer use of other temporary power failure. If, however, the unit is not used for a long time, the memory may be erased. If so, it can be re-programmed by simply following the original procedure.

### TO PLAY PROGRAM SOURCE

1. Select the program source to be heard with the input selector.
2. Play the program source.
3. Adjust the VOLUME control, TONE controls, DNC switch and SIMULATED STEREO switch accordingly.

### TO RECORD PROGRAM SOURCE

1. Select the program source to be recorded with the REC OUT selector. To record broadcasting program, set the VIDEO REC OUT selector to SOURCE A & V position and press the TUNER input selector.
2. To listen to program source to be recorded, press the corresponding input selector.
3. Play the program source to be recorded and set the tape deck connected to TAPE 1 and/or 2 jacks or video cassette recorder connected to AUDIO SIGNAL VCR 1 or 2 jacks to record mode.

4. To listen to other program source during recording, select the program source to be listened to with the input selector. While recording broadcasting program, other program source cannot be heard.

When your tape deck has three head monitoring capability, press the corresponding tape input selector to listen to just recorded signal.

The settings of the TONE controls and VOLUME control do not affect the recording.

### TO DUB AUDIO TAPES (TAPE 1 → TAPE 2)

1. Set the AUDIO REC OUT selector to TAPE 1 and VIDEO REC OUT selector to the position other than SOURCE A & V position.
2. To listen to program source to be recorded, press the TAPE 1 input selector.
3. Set the tape deck connected to TAPE 1 jacks to play mode and set the tape deck connected to TAPE 2 jacks to record mode.

# RX-900U

4. To listen to other program source during dubbing, select the program source to be listened to with the input selector.

When your tape deck has three head monitoring capability, press the corresponding tape input selector to listen to just recorded signal.

The settings of the TONE controls and VOLUME control do not affect the dubbing.

## **TO RECORD VIDEO SOURCES**

1. Select the desired program source to be recorded with the AUDIO and VIDEO REC OUT selectors.  
To record other audio source onto the video tape, set the AUDIO REC OUT selector to the desired position.

### **Example**

#### **To record VCR 2 picture onto VCR 1 with TAPE 1 sound**

Set the VIDEO REC OUT selector to VCR 2 and set the AUDIO REC OUT selector to TAPE 1.

2. Set the VCR connected to AUDIO SIGNAL VCR 1 and/or 2 jacks to the record-pause mode.
3. Play the video source to be recorded and start recording with the recording VCR at the same time.

## **TO DUB VIDEO TAPES**

1. Set the AUDIO and VIDEO REC OUT selectors to VCR 1 or 2.
2. Set the video cassette recorder selected with the REC OUT selectors to play and set other video cassette recorder to record.
- The settings of the VOLUME control and TONE controls does not affect the recording.

## **TO RECORD (DUB) VIDEO SOURCES WHILE ACTIVATING VIDEO LEVEL CONTROL**

1. Set the VIDEO REC OUT selector to SOURCE A & V position.
2. Select the video source to be recorded with the input selector key.
3. Play the video source, set the VIDEO ENHANCER button to ON and adjust the VIDEO LEVEL control.  
After adjusting the VIDEO LEVEL control, stop the video source.
4. Play the video source from the point to be recorded and start recording with the recording VCR at the same time.



## TECHNICAL INFORMATION

Total harmonic distortion vs Output power (MAIN IN – SPEAKERS)

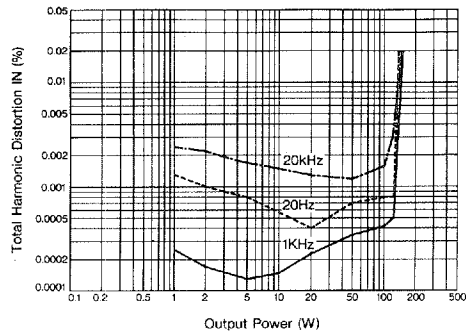

Characteristics of Continuous Variable LOUDNESS control

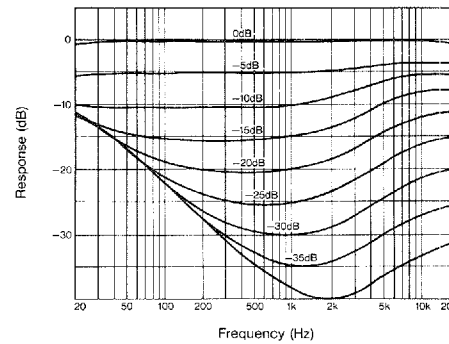

TONE control characteristics

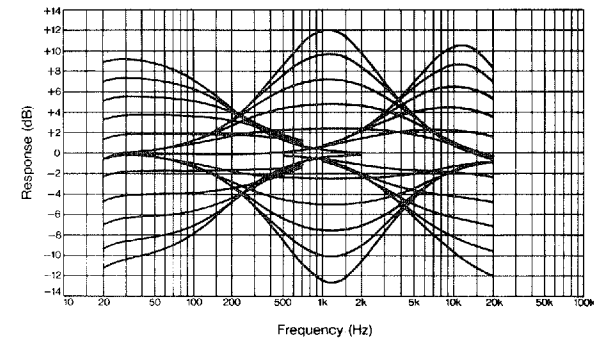

Frequency response/stereo separation vs Modulation frequency

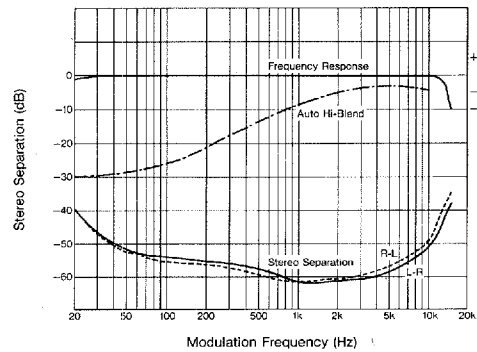

FM antenna input vs Output and noise level/stereo separation

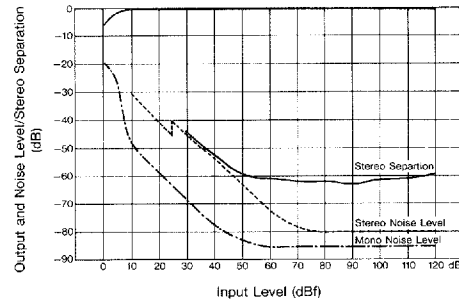

FM alternate channel selectivity

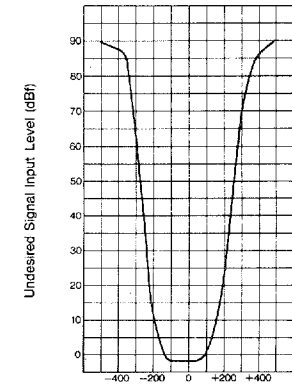

Undesired Carrier Frequency's Deviation from Desired Carrier Frequency (kHz)

# RX-900U

## TROUBLESHOOTING

If the unit fails to operate normally, check the following points to determine whether the fault can be corrected by the simple measures suggested. If it cannot be corrected, or if the fault is not listed in the SYMPTOM column, disconnect the power cord and contact your dealer or service center for help.

	SYMPTOM	CAUSE	REMEDY
Amplifier	The receiver fails to turn on when the POWER switch is pressed.	Power cord is not plugged in or is not completely inserted.	Firmly plug in the power cord.
	No sound.	Incorrect output cord connections.	Connect cord properly. If the problem persists, the cables may be defective.
		Incorrect receiver operation.	Set the receiver controls to the correct input selection.
	Sound "hums".	Incorrect cord connections.	Firmly connect the audio plugs. If the problem persists, the cord may be defective.
	No picture.	Incorrect cord connections. Wrong video unit selected. Video unit not turned on.	Connect the video plugs correctly. Select correct video unit. Turn video unit on.
FM	FM stereo reception is noisy.	Because of the characteristics of FM stereo broadcasts, this is limited to cases where the transmitter is far away or the antenna input is poor.	Check the antenna connections. Try using a multiple element FM antenna.
	There is distortion and clear reception cannot be obtained even with a good FM antenna.	There is multipath interference.	Adjust antenna placement to eliminate multipath interference.
	A desired station cannot be tuned in with Auto tuning.	The station is too weak.	Use Manual tuning mode. Use high quality directional FM antenna.
AM	A desired station cannot be tuned in with Auto tuning.	Weak signal or loose antenna connections.	Tighten the AM loop antenna connections and rotate it for best reception.
			Use Manual tuning mode.
	There are continuous crackling and hissing noises.	These noise result from lightning, fluorescent lamps, motors, thermostats and other electrical equipment.	Use an outdoor antenna and a ground wire. This will help somewhat but it is difficult to eliminate all noise.
	There are buzzing and whining noises (especially in the evening).	A television set is being used nearby.	Move the television away.

## SPECIFICATIONS

### AUDIO SECTION

Minimum RMS Output Power per Channel	
8 ohms, 20 Hz to 20 kHz,	
0.015% THD	85 W
6 ohms, 20 Hz to 20 kHz,	
0.03% THD	100 W
Dynamic Power per Channel	
(IHF, 8 ohms)	130 W
(IHF, 6 ohms)	150 W
(IHF, 4 ohms)	190 W
Dynamic Headroom	
8 ohms	1.84 dB
Power Band Width	
8 ohms, 42.5 W,	
0.08 % THD	10 Hz - 50 kHz
Damping Factor	
(8 ohms, 1 kHz)	60
Input Sensitivity/Impedance	
PHONO	
MC	160 $\mu$ V/220 ohms
MM	2.5 mV/47 k-ohms
CD/TAPE/VDP/VCR	150 mV/47 k-ohms
MAIN IN	1 V/47 k-ohms
Input Sensitivity (New IHF)	
PHONO	
MC	17 $\mu$ V
MM	0.27 mV
CD/TAPE/VDP/VCR	16.3 mV
Maximum Input Signal Level (1 kHz)	
PHONO	
MC	8 mV
MM	110 mV

Output Level/Impedance	
REC OUT	150 mV/470 ohms
PRE OUT	1V/1 k-ohm
Maximum Voltage Output	
0.01 % THD, 20 Hz to 20 kHz	2.5 V
Headphone Jack Rated Output/Impedance	
8 ohms, 0.015% THD	0.75 V/270 ohms
Frequency Response (20 Hz to 20 kHz)	
CD/TAPE/VDP/VCR	$\pm 0$ dB
	$\pm 0.3$ dB
MAIN IN	$\pm 0$ dB
	$\pm 0.3$ dB
RIAA Equalization Deviation	
PHONO	
MC	$\pm 0.5$ dB
MM	$\pm 0.3$ dB
Total Harmonic Distortion (20 Hz to 20 kHz)	
PHONO MC to REC OUT	
(3 V)	0.005%
PHONO MM	
(3 V)	0.003%
CD/TAPE/VDP/VCR to SP OUT	
(42.5 W/8 ohms)	0.015%
VIDEO to SP OUT	
(42.5 W/8 ohms)	0.02%
Intermodulation Distortion	
CD/TAPE/VDP/VCR	
(Rated Output/8 ohms)	0.01%

Signal to Noise Ratio (IHF-A Network)	
PHONO MC	
(500 $\mu$ V Input Shorted)	75 dB
PHONO MM	
(5 mV Input Shorted)	92 dB
CD/TAPE/VDP/VCR	
(Shorted)	103 dB
VIDEO (Shorted)	91 dB
Signal to Noise Ratio (New IHF)	
PHONO	
MC	75 dB
MM	75.5 dB
CD/TAPE/VDP/VCR	81 dB
Residual Noise	
(IHF-A Network)	120 $\mu$ V
Channel Separation (1 kHz, Vol. -30 dB)	
PHONO MC, MM Input Shorted	60 dB
CD/TAPE/VDP/VCR Input 5.1 k-ohms	
Terminated	60 dB
Tone Control Characteristics	
BASS	
Boost/cut	$\pm 10$ dB (50 Hz)
Turnover Frequency	350 Hz
TREBLE	
Boost/cut	$\pm 10$ dB (20 kHz)
Turnover Frequency	3.5 kHz
MID	
Control range	$\pm 12$ dB (1 kHz)
Center frequency	1kHz
Filter Characteristics	
Low Filter	10 Hz, -12 dB/oct

# RX-900U

Continuous Loudness Control ..... -40 dB (1 kHz)  
 (Level related equalization)  
 Audio Muting ..... -20dB

## VIDEO SECTION

Type ..... NTSC Standard  
 Horizontal Resolution ..... 525 lines, 60 field  
 Video Input ..... 1.0 Vp-p, 75 ohms,  
 Unbalanced  
 Video Output ..... 1.0 Vp-p, 75 ohms,  
 Unbalanced  
 Maximum input Level ..... 1.5 Vp-p, 75 ohms,  
 Unbalanced  
 Video Signal to Noise Ratio ..... 52 dB  
 Video Level Control ..... -3 to +3 dB

## FM SECTION

Tuning Range ..... 87.5 to 108 MHz  
 50 dB Quieting Sensitivity (IHF), 75 ohms  
 Mono ..... 1.5  $\mu$ V (14.8 dBf)  
 Stereo ..... 20  $\mu$ V (37.3 dBf)  
 Usable Sensitivity  
 (30 dB S/N Quieting)  
 75 ohms, 1 kHz,  
 100% mod. .... 0.75  $\mu$ V (8.8 dBf)  
 Image Response Ratio ..... 40 dB  
 IF Response Ratio ..... 90 dB  
 Spurious Response Ratio ..... 70 dB  
 AM Suppression Ratio ..... 55 dB

Capture Ratio ..... 1.2 dB  
 (WIDE)  
 2.5 dB  
 (NARROW)

Alternate Channel Selectivity ..... 85 dB  
 Signal to Noise Ratio  
 (IHF)  
 Mono ..... 85 dB  
 Stereo ..... 81 dB  
 Distortion  
 Mono:  
 100 Hz ..... 0.05%  
 1 kHz ..... 0.05%  
 6 kHz ..... 0.1%  
 Stereo:  
 100 Hz ..... 0.07%  
 1 kHz ..... 0.07%  
 6 kHz ..... 0.15%

Stereo Separation  
 50 Hz ..... 45 dB  
 1 kHz ..... 54 dB  
 10 kHz ..... 45 dB  
 Frequency Response  
 30 Hz to 13 kHz ..... 0  $\pm$ 0.5 dB

## AM SECTION

Tuning Range ..... 530 to 1,620 kHz  
 Usable Sensitivity ..... 250  $\mu$ V/m  
 Selectivity ..... 24 dB  
 Signal to Noise Ratio ..... 50 dB  
 Image Response Ratio ..... 40 dB  
 Spurious Response Ratio ..... 50 dB  
 Distortion ..... 0.3%

## AUDIO SECTION

Output Level/Impedance  
 FM (100% mod., 1 kHz) ..... 500 mV  
 /2.8 k-ohms  
 AM (30% mod., 400 Hz) ..... 150 mV  
 /2.8 k-ohms

## GENERAL

Power Supply ..... AC 120 V, 60 Hz  
 Power Consumption ..... 300 W  
 AC Outlets  
 Switched ..... 100 W max.  
 Unswitched ..... 200 W max.  
 Dimensions  
 (W x H x D) ..... 435 x 151 x 423 mm  
 (17-1/8" x 5-15/16"  
 x 16-5/8")  
 Weight ..... 11 kg (24 lbs. 4 oz.)  
 Accessories ..... Remote control cable  
 (mini-plug) x 1  
 Remote control cable  
 (6-pin) x 1  
 Remote control  
 transmitter x 1  
 Battery x 2  
 AM loop antenna x 1  
 Indoor FM antenna x 1  
 75-ohm/300-ohm  
 antenna adapter x 1

Specifications subject to change without notice.



SINCE 1887  **YAMAHA**  
NIPPON GAKKI CO., LTD. HAMAMATSU, JAPAN