



POCKET RECORDER

POCKETRAK W24

Reference Manual

Table of Contents

1 Starting Up	4	5 Playback Settings	29
Part names and functions	4	Changing the playback speed	29
Front, side and back panels	4	Playing back specific sections of a track	30
Remote control	7	Using the Skip playback function	30
LCD screen	8	Using the A-B Repeat playback function	31
2 Recording	9	Using the Phrase playback function	31
Recording with an external microphone.....	9	Playing back the same track repeatedly	32
Recording from an external audio device		Locating a playback position by time	
(such as a CD player)	10	(Time Search function)	33
3 Recording Settings	12	Setting the sound EQ (equalizer)	34
Using a preset or custom recording scene	12	About the sound EQ options	34
Selecting a recording scene.....	12	Selecting a sound EQ option	35
Recording with the selected recording scene..	13	Customizing the sound EQ option.....	36
Modifying the recording scene settings.....	13	6 Using the Tuner Function	37
Changing the Recording mode		Tuning your musical instrument.....	37
(Selecting a sound quality)	16	Calibrating the standard pitch	37
Changing Recording mode	16	7 Using the Metronome Function ..	38
Turning the ALC (Auto Level Control)		Using the metronome	38
on and off.....	17	Setting the metronome tempo (speed)	38
Setting the microphone sensitivity		Setting the metronome beats	39
(MIC SENS).....	17	Playing the metronome during recording	39
Setting the recording EQ (equalizer)	18	8 Editing Files	40
About recording EQ options.....	18	Dividing files.....	40
Selecting a recording EQ option.....	19	Using the fade in and fade out effects	42
Customizing the recording EQ	20	Applying the fade in effect	42
Setting the recording peak limiter	21	Applying the fade out effect	43
Setting the High Pass Filter (HPF)	21	Inserting and deleting index marks.....	43
Setting the recording peak hold indication ...	21	Inserting index marks	43
VAS (Voice Activated System) recording	22	Deleting index marks.....	43
Setting the voice sensing level (VAS value).....	22	Using the Playlist function	
Setting the Auto Divide function		(available only for the MUSIC folder).....	44
(AUTO DIVIDE).....	23	Assigning the folder and files to a Playlist (P1–5)...	44
Recording with the self timer	24	Changing the playback sequence in a Playlist	
Changing the LED setting.....	25	(P1–5).....	45
4 Playback	26	Removing a file from a Playlist (P1–5).....	45
Playing files	26	Removing all files from a Playlist (P1–5)	46
Playing back tracks from the Playlist	27		
Indicators displayed during playback.....	27		
Fast forwarding and fast reversing.....	28		
Using headphones	28		

9 Deleting.....	47	12 Using the Recorder with a Computer.....	63
Managing the Recycle Bin	47	Computer system requirements	63
Activating the Recycle Bin function	47	Connecting the recorder to your computer...	63
Displaying the Recycle Bin folder.....	48	Disconnecting the recorder from your computer	64
Playing back a file in the Recycle Bin folder	48	Troubleshooting (Windows Vista/XP).....	64
Restoring a file from the Recycle Bin folder.....	49	About files and folders.....	65
Emptying the Recycle Bin folder.....	50	About the file naming rules	70
Deleting a selected file.....	51	Transferring audio files from the recorder to a computer.....	71
Deleting all files from a folder	52	Copying audio files to a CD-R.....	72
Formatting the internal memory/ a microSD card (Deleting all data)	53		
10 Using the Timer Function	54	13 Using the Recorder as a Music Player.....	73
Programming a timer	54	Ripping CDs (Creating compatible music files from music CDs).....	73
11 Preference Settings.....	58	Transferring music files to the Recorder (Sync function).....	75
Setting the current date and time.....	58	Playing back tracks in a specific sequence.....	77
Setting the beep sound	59	Creating a Playlist.....	77
Settings related to remote control operation ..	59		
Activating the Auto Power Off function.....	60	14 Installing Cubase AI.....	78
Setting the Backlight function.....	61		
Adjusting the LCD contrast.....	61	15 Appendix	79
Initializing the menu settings	62	Error messages	79
Checking the firmware version.....	62	Troubleshooting.....	81
		FAQ.....	86
		Specifications	87
		Index.....	89

About the manuals

The operation of the POCKETRAK W24 is explained in this Reference Manual (this file) and also in the Owner's Manual (printed version).

Owner's Manual (printed version): The Owner's Manual includes information about precautions, setup and basic operation that will get you started as easily as possible.

Reference Manual (this file): The Reference Manual includes part names and functions, detailed descriptions and procedures that will help you take full advantage of the POCKETRAK W24, and troubleshooting information.

Copyrights

- Copying of the commercially available musical data is strictly prohibited except for your personal use.
- This Reference Manual is the exclusive copyrights of Yamaha Corporation.
- Windows is a registered trademark of Microsoft® Corporation in the United States and other countries.
- Apple, Mac and Macintosh are trademarks of Apple Inc., registered in the U.S. and other countries.
- The microSD and microSDHC logos are trademarks.
- The company names and product names in this manual are the trademarks or registered trademarks of their respective companies.
- The illustrations and LCD screens shown in this manual are for instructional purposes only and may appear somewhat different from those on your instrument.

1 Starting Up

Part names and functions

Front, side and back panels

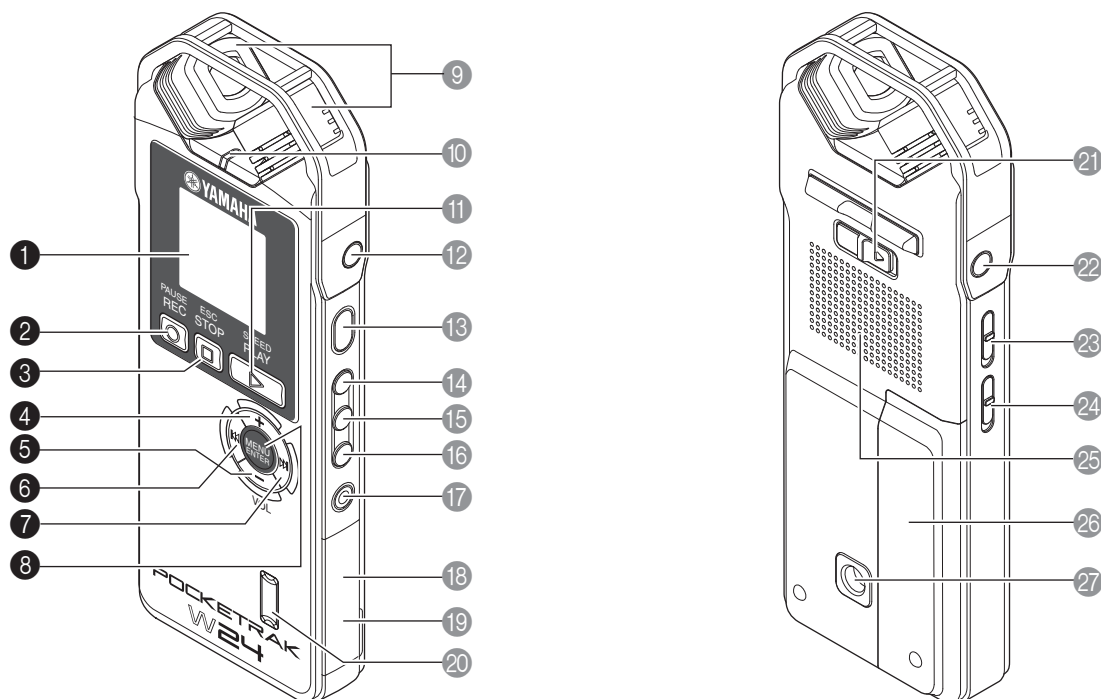

- ❶ **LCD screen**
- ❷ **[REC/PAUSE ○] button**
Starts or pauses recording.
- ❸ **[STOP/ESC □] button**
Stops recording or playback. Press this button during the menu setting operation to return to the previous screen or setting.
- ❹ **[VOL +] button**
Increases the output volume of the speaker or headphones. Also, it moves the cursor upward during menu operation or file selection.
- ❺ **[VOL -] button**
Decreases the output volume of the speaker or headphones. Also, it moves the cursor downward during menu operation or file selection.
- ❻ **[◀◀] button**
Locates the beginning of the previous file, or fast reverses a file. Also, use this button to return to the previous screen during the menu setting operation or while the list screen is displayed, move the cursor to the left, or set the recording level.
- ❼ **[▶▶] button**
Locates the beginning of the next file, or fast forwards a file. Also, use this button to proceed to the next screen during the menu setting operation or while the list screen is displayed, move the cursor to the right, or set the recording level.
- ❽ **[MENU/ENTER] button**
While the main screen is displayed, press and hold down this button for at least two (2) seconds to display the menu screen. During the menu setting operation or while the list screen is displayed, press this button once to confirm the item selection or the operation.

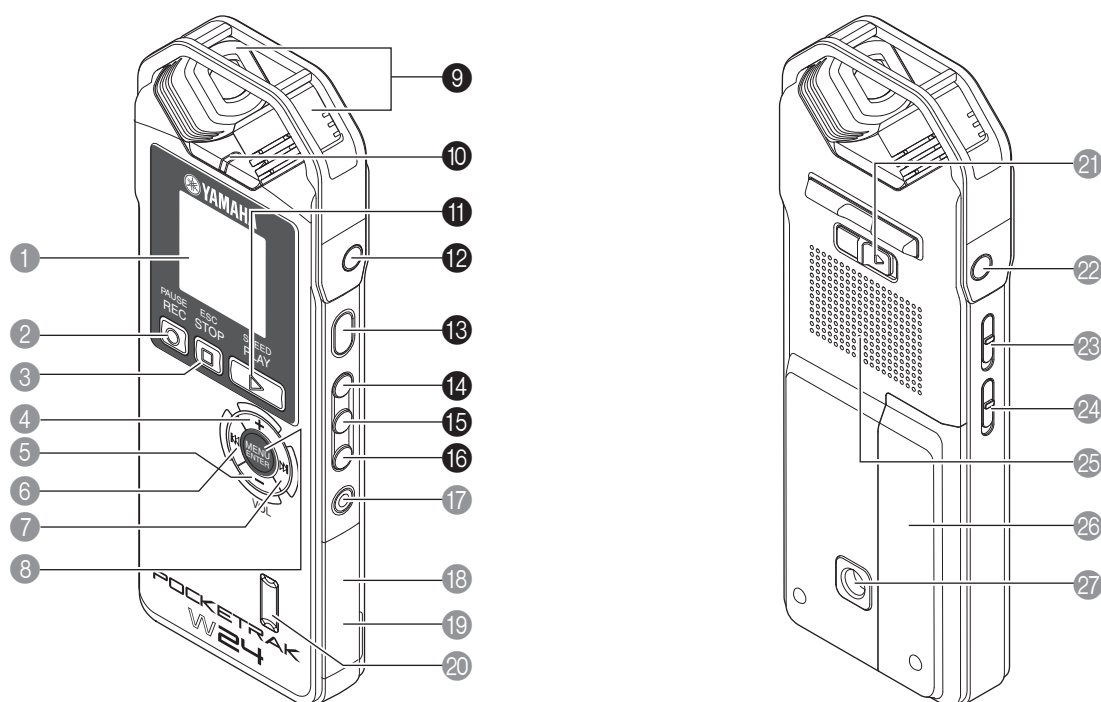

- 9 Built-in stereo microphone**
The recorder features a high-performance X-Y stereo microphone.
- 10 LED indicator**
Lights up or flashes red during recording and lights up green during playback.
[▶ Changing the LED setting \(page 25\)](#)
- 11 [PLAY/SPEED ▶] button**
Starts playback or changes the playback speed in stages.
[▶ Playback \(page 26\)](#)
[▶ Changing the playback speed \(page 29\)](#)
- 12 MIC/LINE  socket**
External stereo microphone/line level input socket.
[▶ Recording with an external microphone \(page 9\)](#)
[▶ Recording from an external audio device \(such as a CD player\) \(page 10\)](#)
- 13 [POWER] button**
Turns the power to the recorder on or off. Press the button once briefly to turn the power on. Press and hold down the button for at least two (2) seconds to turn the power off.
- 14 [FOLDER/A-B REPEAT] button**
Displays the folder select screen, or executes A-B repeat playback.
- 15 [LIST/INDEX] button**
To display a list of files in the selected folder, press this button while the recorder is stopped.
Press this button during recording or playback to insert index marks (playback position locators).
[▶ Inserting and deleting index marks \(page 43\)](#)
- 16 [SCENE/PHRASE] button**
Recalls a recording scene while the unit is stopped. Alternatively, use this button to perform Phrase playback (the playback point will be moved back by the specified number of seconds).
[▶ Using a preset or custom recording scene \(page 12\)](#)
[▶ Using the Phrase playback function \(page 31\)](#)

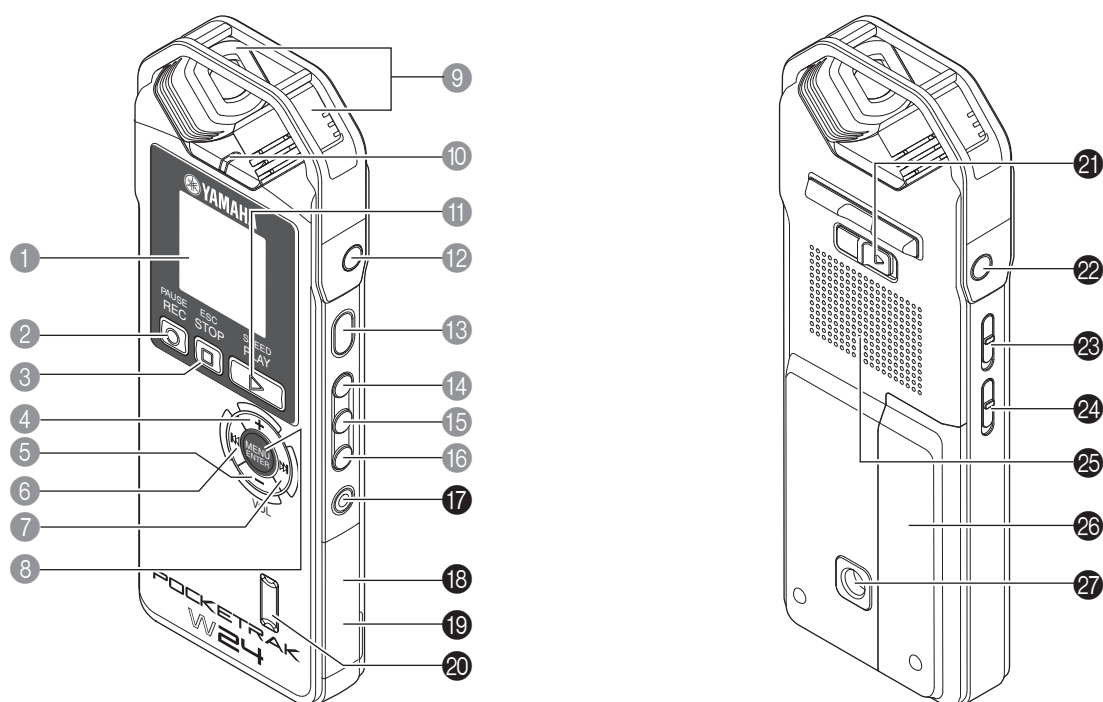

- 17 [DELETE] button**
Deletes files, folders, or index marks. It also recalls the Recycle Bin menu while the Recycle Bin folder is selected.
📖 [Deleting \(page 47\)](#)
- 18 microSD card slot**
Insert a microSD card here.
- 19 USB terminal**
Connect this terminal to a computer using the included USB cable.
- 20 Remote sensor**
Receives remote control signals.
- 21 [HOLD] switch**
To engage the Hold function (to avoid accidental operation), slide the switch in the direction of the arrow.
- 22 Headphones socket**
Connect inner-ear headphones or other types of headphones here.
- 23 [ALC ON/OFF] switch**
Set this switch to ON to automatically adjust the recording level in accordance with the source level to optimize the dynamics of the resulting recording.
📖 [Turning the ALC \(Auto Level Control\) on and off \(page 17\)](#)
- 24 [MIC SENS HIGH/LOW] switch**
Switches the microphone sensitivity to high or low in accordance with the recording environment.
- 25 Speaker**
- 26 Battery cover**
- 27 Threaded socket for attaching a tripod or a microphone stand adapter**
Use this socket to attach a tripod or a microphone stand adapter.
📖 [Refer to the Owner's Manual](#)

Remote control

Pressing any remote control button will cause the recorder to emit a beep (unless other recorder settings override this function).

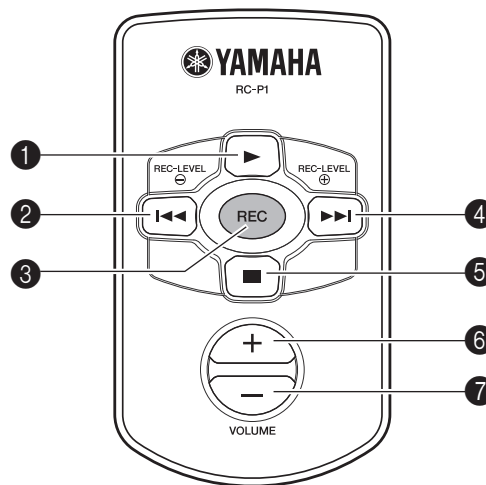

- ① **[▶] button**
Starts playback.
- ② **[◀◀] button**
Locates the beginning of a file, or fast reverses a file. Alternatively, this button enables you to lower the REC LEVEL.
- ③ **[REC] button**
Starts recording.
- ④ **[▶▶] button**
Locates the beginning of a file, or fast forwards a file. Alternatively, this button enables you to raise the REC LEVEL.
- ⑤ **[■] button**
Stops recording or playback.
- ⑥ **VOLUME button (+)**
Raises the playback volume level.
- ⑦ **VOLUME button (-)**
Lowers the playback volume level.

LCD screen

The unit will not display all the following indicators and items at the same time.

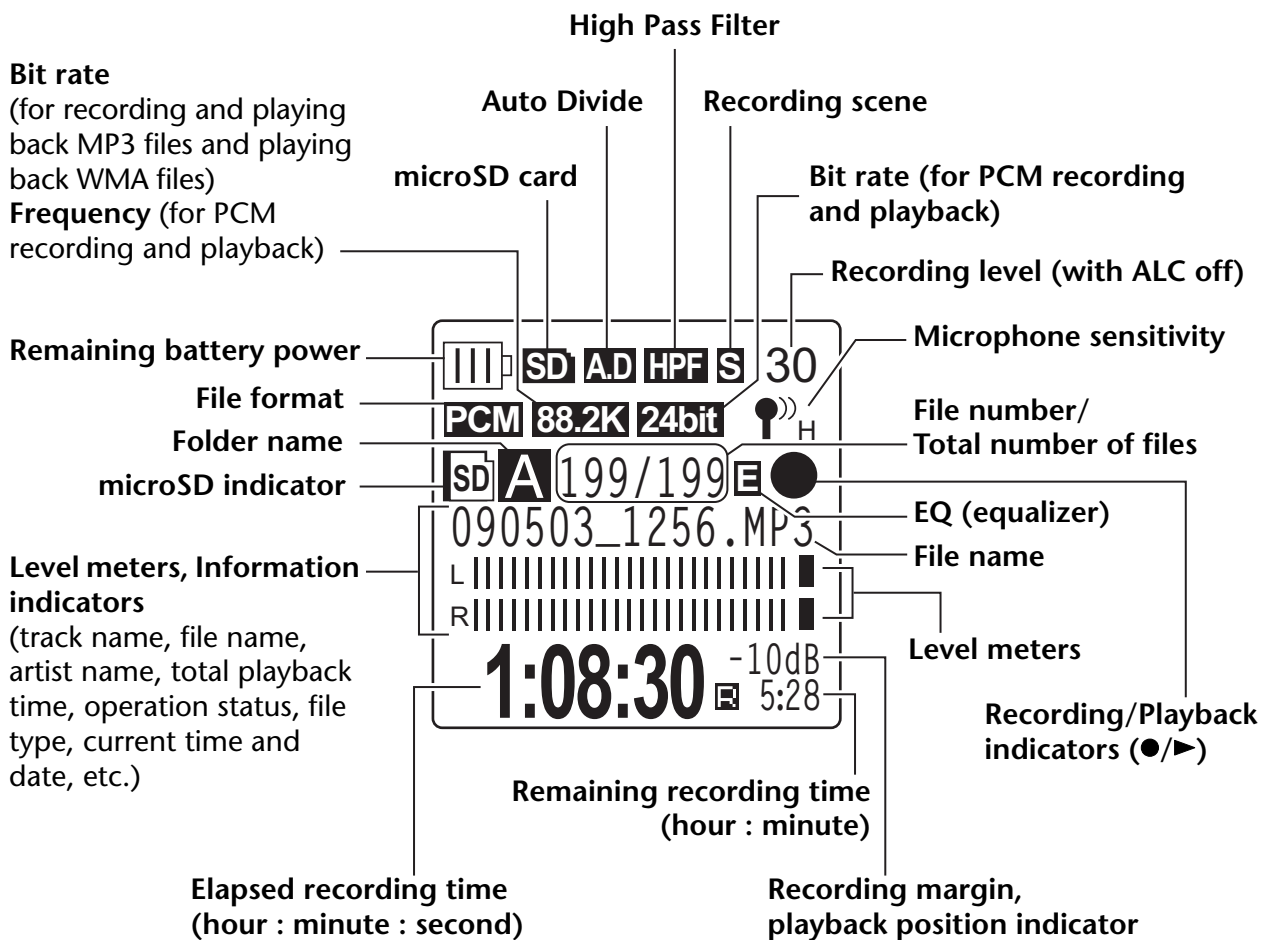

Hint:

· What is Linear PCM (Pulse Code Modulation) recording?

Linear PCM (LPCM) recording is a digital recording method that samples analog audio signals at a certain frequency and saves them as digital signals without compression. Music CDs (CD-DA-CD digital Audio) use PCM recording (sampling rate of 44.1 kHz, bit depth of 16-bit samples, bit rate of 1,411 kbps, and frequency response from 20 to 20kHz).

PCM recordings are digitally-recorded unprocessed audio, and are supposed to be of the highest sound quality. "WAVE" format is used to import these PCM recording files into a computer. The WAVE file extension is ".WAV". MP3 and WMA format files are created by compressing the LPCM data.

· Recording margin indicator

Recording margin: space or margin (expressed in dB) between 0dB and the input peak levels.

2 Recording

For information on recording preparation and how to record musical performances or conference meetings using the built-in microphone, please refer to the Owner's Manual (printed version).

Recording with an external microphone

You can use an external microphone for recording (instead of using the built-in stereo microphone). For an external microphone, you can use a stereo or monaural powered microphone, or a stereo or monaural dynamic microphone. To set up the recorder for your type of external microphone, follow the steps below:

1. Press the [MENU/ENTER] button for at least two (2) seconds while the main screen is displayed, press the [VOL +/-] buttons to select [REC MENU] → [REC SELECT], then press the [MENU/ENTER] button.
2. Press the [VOL +/-] buttons to select [EXTERNAL MIC], then press the [MENU/ENTER] button.

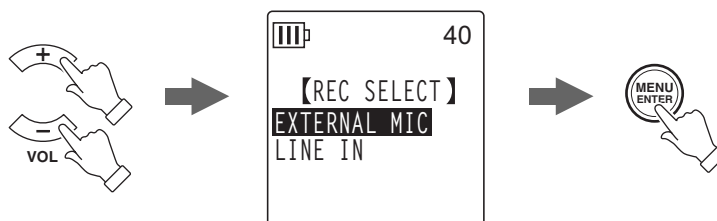

3. Press the [VOL +/-] buttons repeatedly to select [POWERED ST], [POWERED MONO], [DYNAMIC ST] or [DYNAMIC MONO] depending on the microphone type, then press the [MENU/ENTER] button.

Press the [STOP/ESC ] button twice to display the main screen.

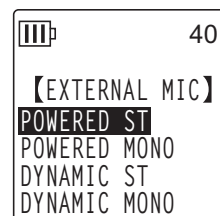

4. Connect the microphone to the recorder's [MIC/LINE] socket located on the right side panel, then point the microphone toward the sound source.
5. Press the [REC/PAUSE ] button on the recorder.
Recording starts.

Yamaha recommends that you use a microphone with the following specifications as an external microphone.

If you use an external microphone with the following specifications, select [POWERED ST] or [POWERED MONO] as the microphone type in Step 3.

Type	Electret condenser microphone that features plug-in power operation
Impedance	2k ohms
Power supply	Guaranteed operation at 1.3V
Plug	Mini plug (ø3.5mm)

Recording from an external audio device (such as a CD player)

You can record line input sources from an external audio device (such as a CD player or MD player).

1. Press the [MENU/ENTER] button for at least two (2) seconds while the main screen is displayed, press the [VOL +/-] buttons to select [REC MENU] → [REC SELECT], then press the [MENU/ENTER] button.
2. Press the [VOL +/-] buttons to select [LINE IN], then press the [MENU/ENTER] button.

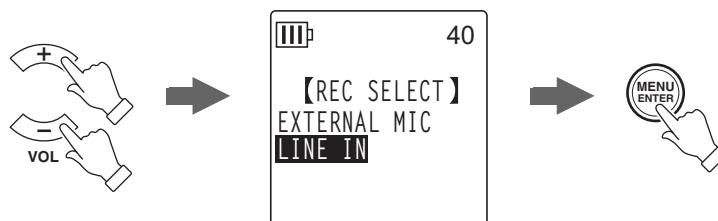

Press the [STOP/ESC ] button twice to display the main screen.

Note:

- For information on how to change the recording mode, see [page 16](#).
- During an MP3 recording, you can use the Auto Divide function (see [page 23](#)).

3. Connect the recorder's [MIC/LINE] socket to the audio output connector on the external device.
Use a commercially-available audio cable (stereo mini plug, 3.5mm, with no resistance).

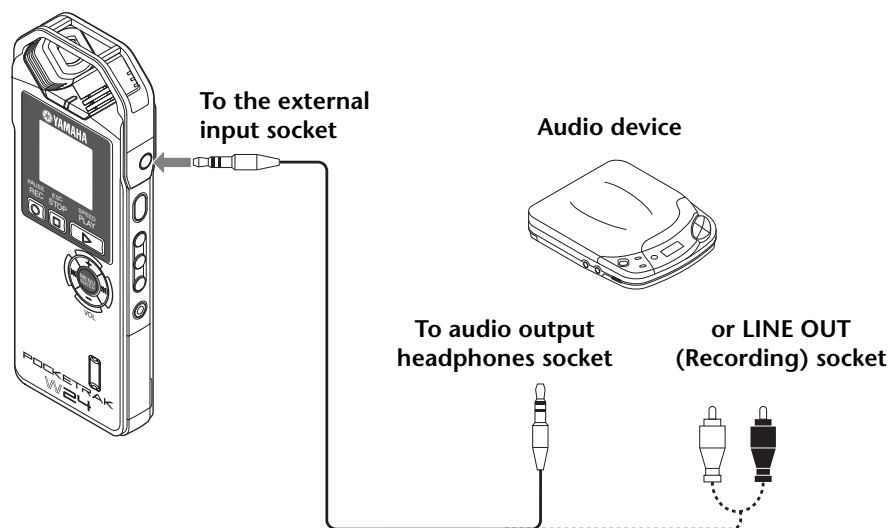

4. Adjust the volume level of the external audio device while playing the recording source.

Hint:

- Try a test recording to find an appropriate recording level.

5. Play the recording source on the external audio device and press the [REC/PAUSE ] button.

Recording starts.

Note:

-
- Recordings are automatically stored in the LINE (L) folder.
 - While you are recording audio through the line input from the connected external device, no audio will be heard from the speaker. Use the headphones to listen to the audio being recorded.
-

6. Press the [STOP/ESC ] button to stop recording.

Stop playback on the external device.

3 Recording Settings

Using a preset or custom recording scene

The recorder features preset and custom recording scenes. Each preset scene is a snapshot of the recording menu settings that would work well in a certain recording environment and application. You can also create your own customized recording scenes.

Selecting a recording scene

The recorder offers four preset recording scenes ([Practice], [Studio], [Outdoor] and [Live]) and three custom recording scenes ([User 1-3]) that enable you to create your own custom scenes by combining different menu settings.

Menu settings \ Scene	OFF	Practice	Studio	Outdoor	Live	User1-3
REC MODE	PCM 44.1kHz 16bit	MP3 128kbps	MP3 192kbps	PCM 96kHz 24bit	PCM 44.1kHz 16bit	MP3 192kbps
INPUT	20	20	20	20	20	20
MIC ALC	OFF/ON	ON	OFF	OFF	OFF	OFF
MIC SENS	HIGH/LOW	HIGH	LOW	HIGH	LOW	HIGH
HPF	OFF	OFF	OFF	ON	OFF	OFF
LIMITER	OFF	ON	ON	OFF	ON	OFF
PEAK HOLD	3 sec	3 sec	3 sec	3 sec	3 sec	3 sec
SELECT	P-ST* ¹	P-ST	P-ST	P-ST	P-ST	P-ST
AUTO DIVIDE	OFF	OFF	OFF	OFF	OFF	OFF
TIMER	OFF	OFF	OFF	OFF	OFF	OFF
VAS	OFF	ON	OFF	OFF	OFF	OFF
VAS LEVEL	3	3	3	3	3	3
REC EQ	RECOMM* ²	RECOMM	RECOMM	FLAT	RECOMM	RECOMM

*1. P-ST is an abbreviation of POWERED ST.

*2. RECOMM is an abbreviation of RECOMMEND.

1. While the main screen is displayed, press the [SCENE/PHRASE] button located on the side panel.

The unit displays the [SCENE SELECT] screen.

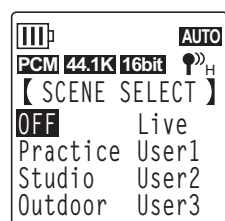



2. Press the [VOL +/-], [◀]/[▶] buttons to select a preferred recording scene, then press the [MENU/ENTER] button.

The unit confirms your selection of a recording scene, and then displays the main screen.

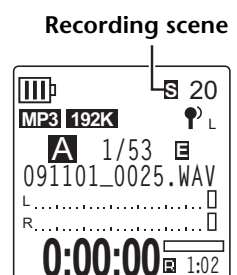
"" will appear in the upper right corner of the LCD.



Recording with the selected recording scene

1. After selecting a recording scene, while the main screen is displayed, press the [FOLDER/A-B REPEAT] button located on the side panel, then press the [VOL +/-], [◀◀]/[▶▶] buttons to select a folder into which to record a file, then press the [MENU/ENTER] button.
2. Press the [REC/PAUSE ] button.
If you have selected the [Practice] recording scene, recording starts immediately.
3. If you have selected any scene other than [Practice], the unit enters recording STANDBY mode. Press the [REC/PAUSE ] button again.

Note:

- If you wish to change the INPUT (recording level), press the [◀◀]/[▶▶] buttons to adjust the level while the unit remains in recording STANDBY mode.

Modifying the recording scene settings

You can modify the recording scene settings and store the edits.

1. While the main screen is displayed, press the [SCENE/PHRASE] button located on the side panel.
2. Press the [VOL +/-], [◀◀]/[▶▶] buttons to highlight the recording scene that you wish to modify.
You cannot modify the settings for the [OFF] scene.

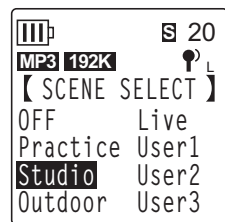

3. While the recording scene is highlighted, press the [SCENE/PHRASE] button again.
The unit displays the scene edit screen.

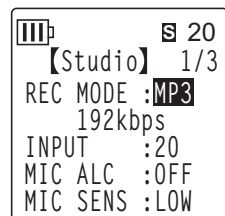

4. Press the [VOL +/-] buttons to select a setting item that you wish to modify, then press the [MENU/ENTER] button.
The unit displays the setting edit screen for the selected item.
5. Modify the setting or value.
 - For [INPUT] (recording level), press the [VOL +/-] buttons to select a value from 0 to 40, then press the [MENU/ENTER] button.

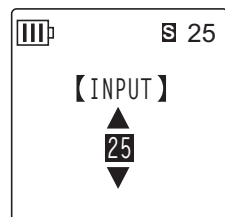

- For [MIC ALC], press the [VOL +/-] buttons to select [ON] or [OFF], then press the [MENU/ENTER] button.

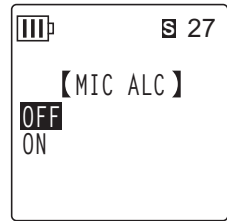

- For [MIC SENS], press the [VOL +/-] buttons to select [HIGH] or [LOW], then press the [MENU/ENTER] button.

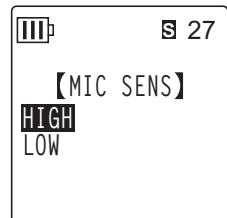

For information on how to set other menu items, refer to the following pages:

- ☞ [REC MODE] (See page 16.)
- ☞ [HPF] (See page 21.)
- ☞ [LIMITER] (See page 21.)
- ☞ [PEAK HOLD] (See page 21.)
- ☞ [SELECT] (Line in) (See page 9.)
- ☞ [AUTO DIVIDE] (See page 23.)
- ☞ [TIMER] (See page 24.)
- ☞ [VAS] (See page 22.)
- ☞ [VAS LEVEL] (See page 22.)
- ☞ [REC EQ] (See page 18.)

To modify other settings, repeat Steps 4 and 5.

6. Press the [VOL +/-] buttons to select [STORE], then press the [MENU/ENTER] button.

The modified recording scene overwrites the existing scene, and the unit displays the [SCENE SELECT] screen.

Note:

- To cancel overwriting the settings, select [CANCEL] instead of [STORE].
- If you try to abort the operation in the middle of the procedure before you select [STORE] or [CANCEL], the message [CANCEL UPDATE ?] will appear on the display. To abort the operation, select [CANCEL], then press the [MENU/ENTER] button.

7. Press the [STOP/ESC □] button to return to the main screen.

■ **Notes regarding modifying the [MIC ALC] and [MIC SENS] settings**

If you change the [ALC] or [MIC SENS] switch setting after selecting a recording scene, the switch setting will be stored in the current scene by overwriting the corresponding setting status. In this case, if you turn off the power to the unit, then turn it on again, the status of the switches on the side panel will be used for the recording settings.

Examples

		When a recording scene is selected	When the [ALC] switch is turned [OFF]	When the power is turned off, then back on
Effective settings	Recording scene	USER 1	OFF	OFF
	MIC ALC	ON	OFF	OFF
	MIC SENS	HIGH	HIGH	LOW
Status of switches on the side panel	ALC switch	ON	OFF	OFF
	MIC SENS switch	LOW	LOW	LOW

■ **Initializing the recording scene settings**

1. While the main screen is displayed, press and hold down the [SCENE/PHRASE] button located on the side panel for at least two (2) seconds.

2. Press the [VOL +/-], [I◀◀]/[▶▶I] buttons to select a recording scene that you wish to initialize, then press the [MENU/ENTER] button.

If you wish to initialize all recording scenes, select [ALL].

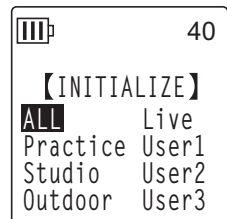

3. Press the [I◀◀]/[▶▶I] buttons to highlight [YES], then press the [MENU/ENTER] button.

The unit initializes the selected recording scene, and then displays the main screen.

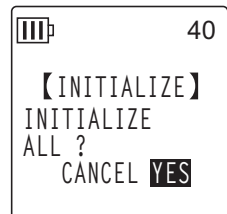

Changing the Recording mode (Selecting a sound quality)

The recorder enables you to record audio in MP3 or PCM (WAV) format. In PCM mode, non-compressed audio data will be recorded. In MP3 mode, compressed audio data will be recorded. With the better sound quality, the data size will be larger and available recording time will be shorter.

Changing Recording mode

1. Press the [MENU/ENTER] button for at least two (2) seconds while the main screen is displayed, press the [VOL +/-] buttons to select [REC MENU] → [REC MODE], then press the [MENU/ENTER] button.
2. Press the [VOL +/-], [◀◀]/[▶▶] buttons to select the desired Recording format from [PCM 24bit],[PCM 16bit],[MP3], then press the [MENU/ENTER] button.
3. Press the [VOL +/-] buttons to select the desired frequency or bit rate, then press the [MENU/ENTER] button.

[REC MODE]	
PCM 320kbps	
24bit 192kbps	
PCM 128kbps	
16bit 64kbps	
MP3 32kbps	

4. Press the [STOP/ESC □] button twice.
The recorder displays the main screen.



Turning the ALC (Auto Level Control) on and off

Note:

- You can turn the ALC function on or off when recording audio to folders A–D.

- **Turning the ALC function on**

Slide the [ALC] switch located on the side panel of the unit to "ON."

The recording level will automatically be adjusted in response to the input level.

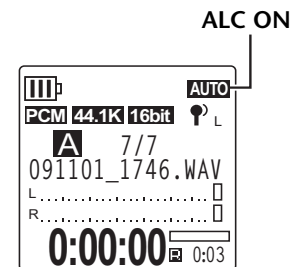

- **Turning the ALC function off**

Slide the [ALC] switch (located on the side panel of the unit) to "OFF."

You can change the recording level in increments (Refer to the Owner's Manual).

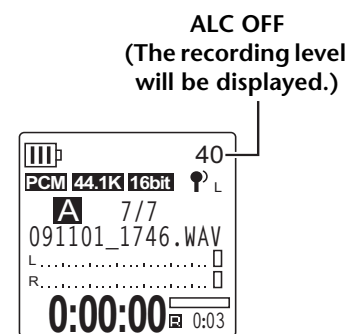

Note:

- You cannot adjust the recording level when you are recording audio from a connected external device (see page 10).

Setting the microphone sensitivity (MIC SENS)

You can set the microphone sensitivity level to high or low to accommodate the recording environment.

- **If the volume level of the recording source is too low:**
Slide the [MIC SENS] switch (located on the side panel) to [HIGH].
- **If the volume level of the recording source is too high:**
Slide the [MIC SENS] switch (located on the side panel) to [LOW].

The indicator displayed in the upper right of the LCD:

When the [MIC SENS] switch is set to [HIGH]: 🎤_H

When the [MIC SENS] switch is set to [LOW]: 🎤_L

Setting the recording EQ (equalizer)

Setting the recording EQ enables to record the audio of the desired tonal quality by boosting the lower or higher frequency ranges.

You can use the recording EQ only when recording audio to folders A–D and when the ALC function is turned off.

About recording EQ options

The recorder offers eight recording EQ presets and one USER recording EQ option (that enables you to customize by cutting and boosting five EQ bands individually). The recording EQ presets include RECOMMEND, FLAT, SUPER BASS, BASS, MIDDLE, BASS&TREBLE, TREBLE, and SUPER TREBLE.

Features of each recording EQ preset

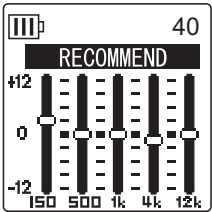
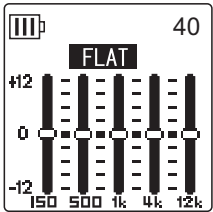
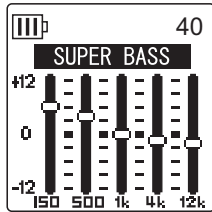
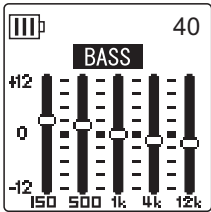
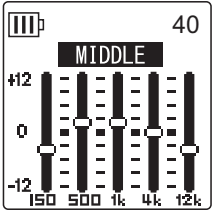
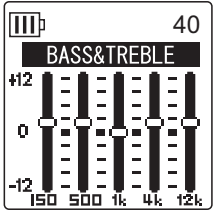
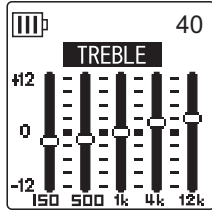
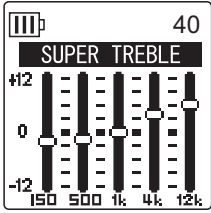
			
<p>This preset is recommended for recording via the built-in microphone.</p>	<p>No EQ is used for recording.</p>	<p>This preset significantly boosts the lower frequency range.</p>	<p>This preset mildly boosts the lower frequency range.</p>
			
<p>This preset boosts the mid frequency range.</p>	<p>This preset mildly boosts the lower and higher frequency ranges.</p>	<p>This preset mildly boosts the higher frequency range.</p>	<p>This preset significantly boosts the higher frequency range.</p>

Note:

- You cannot change the parameters of these eight recording EQ presets. Select the USER recording EQ option if you wish to customize the recording EQ.

Selecting a recording EQ option

1. Set the [ALC] switch to "OFF."
2. Press the [FOLDER/A-B REPEAT] button → the [VOL +/-], [◀]/[▶] buttons to select a folder into which to record, then press the [MENU/ENTER] button.
Select a folder from folders A–D.

3. Press the [REC/PAUSE ] button.
The unit displays the [STANDBY] indicator.

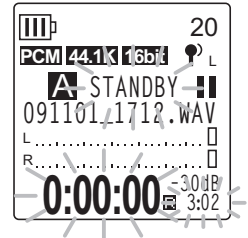

4. Press and hold down the [MENU/ENTER] button for at least two (2) seconds while the [STANDBY] indicator is displayed.
The unit displays the REC MENU screen.

5. Press the [VOL +/-] buttons to select [RECORDING EQ], then press the [MENU/ENTER] button.
The unit displays the recording EQ screen.

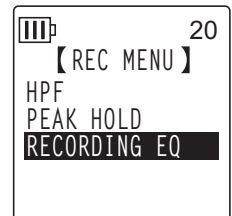



6. Press the [◀]/[▶] buttons to select the desired recording EQ option.
You can select from eight recording EQ presets and one USER recording EQ (which enables you to customize the EQ settings).

Hint:

- For information on how to customize the USER recording EQ option, refer to "Customizing the recording EQ" on [page 20](#).

7. Press the [MENU/ENTER] button.

The selection of the recording EQ is confirmed. Press the [STOP/ESC ] button to display the [STANDBY] indicator. Adjust the recording level, then press the [REC/PAUSE ] button again to start recording.

Note:

- To cancel the operation, press the [STOP/ESC ] button.

Customizing the recording EQ

The USER recording EQ enables you to customize the level of five EQ bands.

1. Select "USER" while the recording EQ screen is displayed.

Refer to steps 1–5 in the "Selecting a recording EQ option" section on [page 19](#).

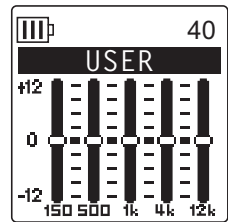

2. Press the [VOL -] button.

The 150Hz band will be selected and displayed as a black bar.

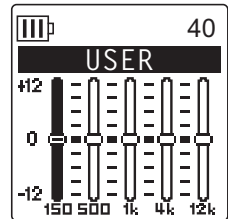

3. Press the [◀◀]/[▶▶] buttons to select a frequency band that you wish to cut or boost.

The selected frequency band will be displayed as a black bar.

4. Press the [VOL +/-] buttons to boost or cut the level of the selected frequency band.

You can boost the level by as much as +12dB or cut the level by as much as -12dB in 1dB steps. The larger value will raise the recording level and boost the frequency band.

Note:

- To adjust the level of other frequency bands, repeat steps 3 and 4.
- To cancel the operation, press the [STOP/ESC □] button.

5. Press the [MENU/ENTER] button.

The USER recording EQ is now customized. Adjust the recording level, then press the [REC/PAUSE ○] button again to start recording.

Note:

- The recording EQ setting is retained when you turn the power off or change the battery. However, the setting will be lost if you change the battery without first turning the power off.

Setting the recording peak limiter

When the recording peak limiter is set to ON, the recorder reduces sound distortion by automatically adjusting excessive peaks. It is recommended that you set the limiter to ON when you are recording audio. The peak limiter is available only when the ALC is set to OFF.

Procedure:

Press the [MENU/ENTER] button for at least two (2) seconds while the main screen is displayed, select [REC MENU] → [REC LIMITER] → [ON], then press the [MENU/ENTER] button.

To cancel the recording peak limiter, select [OFF].

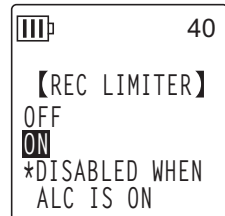

Setting the High Pass Filter (HPF)

You can cut the low frequency range by switching the High Pass Filter on. The filter reduces the level of chatting voices, wind and other noise in the recording environment and enables you to record clearer audio.

Procedure:

Press the [MENU/ENTER] button for at least two (2) seconds while the main screen is displayed, select [REC MENU] → [HPF (High Pass Filter)] → [ON], then press the [MENU/ENTER] button.

The **HPF** indicator will appear on the main screen.

To cancel the High Pass Filter, select [OFF].

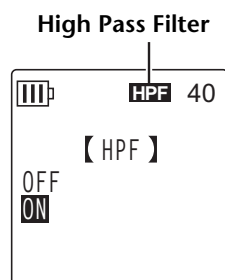

Setting the recording peak hold indication

You can set the duration of the recording peak hold indication displayed on the LCD. This setting is useful when you want to record live with the recording level set to maximum.

Procedure:

1. Press and hold down the [MENU/ENTER] button for at least two (2) seconds while the main screen is displayed, select [REC MENU] → [PEAK HOLD], then press the [MENU/ENTER] button.

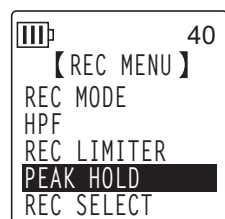

2. Press the [VOL +/-] buttons to set the peak hold time to [INF] (infinity) or a value from 0 to 10 seconds, then press the [MENU/ENTER] button.

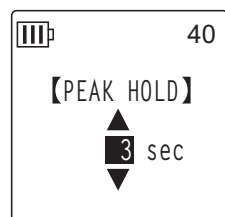

3. Press the [STOP/ESC] button twice.
The unit displays the main screen.

VAS (Voice Activated System) recording

When the VAS recording function is turned on, if the unit is in recording pause mode, the unit will automatically start to record as soon as it detects audio at a level above a certain threshold. The unit will pause recording when the detected audio level falls below the threshold. **VAS recording is available only when ALC is set to ON.**

Note:

- Audio at a level below a certain threshold will be undetected and will not be recorded. If you are planning to record important audio, set the VAS recording to OFF.

1. Press the [MENU/ENTER] button for at least two (2) seconds while the main screen is displayed, select [REC MENU] → [VAS] → [ON], then press the [MENU/ENTER] button.

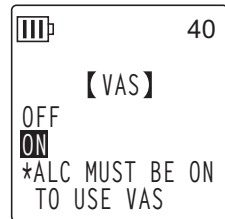

2. Press the [STOP/ESC] button twice.

The **VAS** indicator will appear on the main screen.

3. Press the [REC/PAUSE] button.

As soon as the unit detects audio, recording begins.

If the unit does not detect any audio, the elapsed recording time indicator, the remaining recording time indicator and the VAS indicator will flash, and the unit will enter Recording Pause mode.

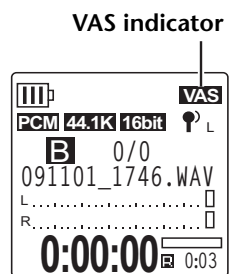

Note:

- If the recorder does not detect any audio or does not pause recording, adjust the threshold by following the procedure in the "Setting the voice sensing level (VAS value)" section below.
- If you start recording while the VAS function is turned on, the first two seconds or so will be recorded with no exception.

Setting the voice sensing level (VAS value)

You can adjust the voice sensing level in five steps (1–5) to accommodate the source volume level. A larger value will increase the voice activation sensitivity so recording will be triggered by lower-level audio. If the value is too small, the recorder may not detect audio. Set the microphone sensitivity (see [page 17](#)) in accordance with the source input level so that the VAS function can work more effectively.

Procedure:

To adjust the voice sensing level, press the [◀◀]/[▶▶] buttons while recording with the VAS function turned on.

VAS value

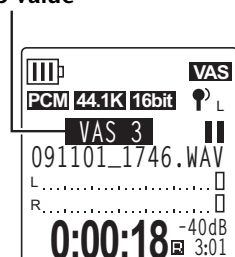

Note:

- If the High Pass Filter is turned on, the filter will cut the low range, and recording may not start. In this case, set the VAS function to Off.

Setting the Auto Divide function (AUTO DIVIDE)

If you turn the Auto Divide function on when recording a line source, such as tracks from a CD player, the unit automatically detects a silent pause between tracks and records each track as an individual file. More specifically, when the recorder detects a silent pause of two seconds or longer, it pauses recording, thus storing the audio data up to the silent pause as one file. In this way, the unit will record the first track as file 1, the second track as file 2, and so on.

This function is available only for MP3 files recorded via Line In. You cannot use this function for PCM line recordings, or PCM or MP3 recordings made by using the built-in or external microphone.

1. Press the [MENU/ENTER] button for at least two (2) seconds while the main screen is displayed, select [REC MENU] → [AUTO DIVIDE] → [ON], then press the [MENU/ENTER] button.

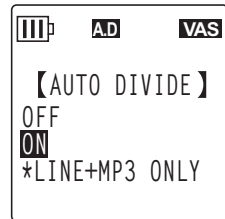

2. Press the [STOP/ESC] button twice.

The unit displays the main screen, including the **A.D** (Auto Divide) indicator.

To cancel the Auto Divide function, select [OFF] in step 1.

Auto Divide indicator

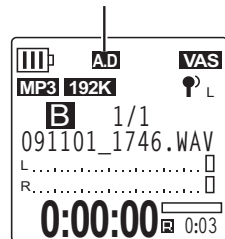

Note:

- The function will not work if the recorder does not detect a silence of two seconds between tracks on a live CD or similar source. In this case, use the Divide File function (see page 40) to manually divide the files.
- If the unit detects silence for 15 seconds or more, recording stops automatically.

Recording with the self timer

You can specify the time duration from the press of the [REC/PAUSE ] button until the start of recording. This function is useful when you need some time to prepare. For example, you may wish to practice your musical instrument until the actual recording starts.

1. Press the [MENU/ENTER] button for at least two (2) seconds while the main screen is displayed, select [REC MENU] → [SELF TIMER], then press the [MENU/ENTER] button.

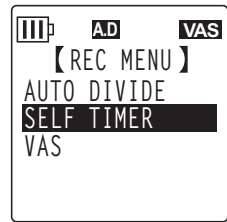

2. Press the [VOL +/-] buttons to select a self timer value of 5, 10 or 30 seconds, then press the [MENU/ENTER] button.

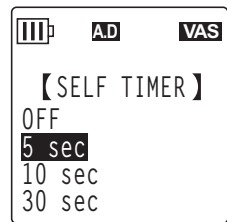

3. Press the [STOP/ESC ] button twice.

The recorder displays the main screen.

4. Press the [FOLDER/A-B REPEAT] button → the [VOL +/-], [I◀◀]/[▶▶I] buttons to select a folder into which to record, then press the [MENU/ENTER] button.

5. Press the [REC/PAUSE ] button.

The recorder displays the self timer standby screen, then starts counting down for the duration specified in step 2. (The LED indicator flashes.)

Note:

- If the [ALC] switch is set to OFF, the unit enters recording standby mode. Adjust the recording level, then press the [REC/PAUSE ] button again.

6. After the time specified in step 2 expires, recording begins.

Note:

- Once self timer recording begins, the self timer recording setting will be stored until you turn the self timer off or initialize the menu settings.

Hint:

- To cancel self timer recording, press the [STOP/ESC ] button during countdown.

Changing the LED setting

You can set the LED indicator so that it will light up during recording or playback (the REC/PLAY option), or NOT light up during recording or playback (the OFF option). Alternatively, you can set the indicator so that it will function as a recording peak LED indicator (the PEAK/PLAY option), in which case the LED indicator will flash only at recording peaks, and otherwise turn off during recording.

1. Press and hold down the [MENU/ENTER] button for at least two (2) seconds while the main screen is displayed, select [COMMON MENU] → [REC/PLAY LED], then press the [MENU/ENTER] button.



2. Press the [VOL +/-] buttons to select [OFF], [REC/PLAY] or [PEAK/PLAY], then press the [MENU/ENTER] button.

[OFF]	The LED indicator remains off during recording, recording standby mode, recording pause mode, and playback.
[REC/PLAY]	The LED indicator lights up red during recording and green during playback. The LED indicator flashes red rapidly during excessive recording peaks. The LED indicator flashes red slowly during recording standby mode or recording pause mode.
[PEAK/PLAY]	The LED indicator flashes red rapidly during excessive recording peaks. The LED indicator remains off during recording, recording standby mode, and recording pause mode. The LED indicator lights up green during playback.

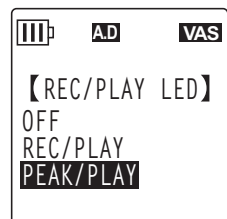

3. Press the [STOP/ESC] button twice.
The unit displays the main screen.

4 Playback

Playing files

The recorder plays MP3 and WMA format files in addition to WAV format files recorded on the unit. To play back a file recorded on the unit, select a folder from the MIC (A–D) folders or the LINE (L) folder. To play back a file transferred from a computer, select the MUSIC (M) folder.

1. While the main screen is displayed, press the [FOLDER/ A-B REPEAT] button located on the side panel.

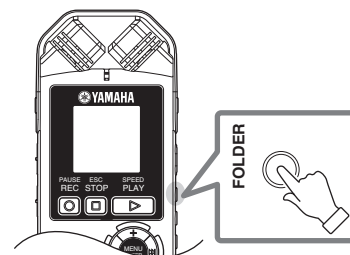

2. Press the [VOL +/-], [◀◀]/[▶▶] buttons to select a folder from which to play back a file.

A–D: Files recorded via a microphone

L: Files recorded via the line connection

M: Files transferred from your computer

P1–P5: Playlists (You can assign tracks in the M folder to Playlists.)
(See [page 44.](#))

(🗑️): Recycle Bin

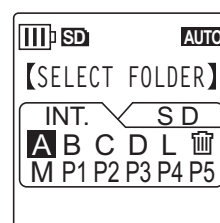

3. Press the [◀◀]/[▶▶] buttons to select the desired file number.

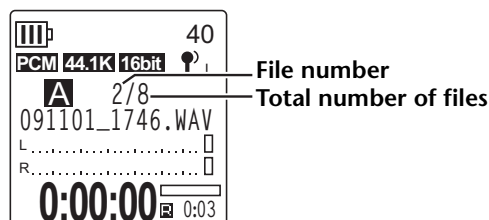

4. Press the [PLAY/SPEED ▶] button.

The recorder starts playing back the file.

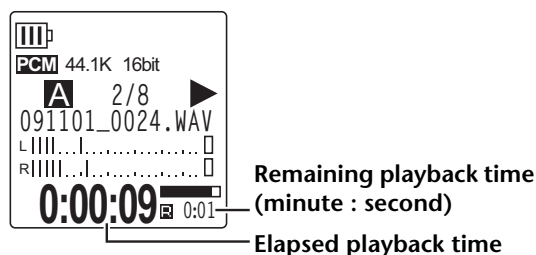

5. Press the [VOL +/-] buttons to set the proper playback volume level.

The level can be set in 21 steps (0–20).

6. Press the [STOP/ESC ◻] button to stop playback.

Press the [PLAY/SPEED ▶] button again to resume playback.

Hint:

· You can play the files in each folder from the list screen (Refer to the Owner's Manual).

Playing back tracks from the Playlist

The recorder offers five Playlist files P1–5 (see page 44). You can also create a Playlist using the computer (see page 77).

This section explains how to play back a Playlist you created on the computer.

1. While the main screen is displayed, press the [FOLDER/A-B REPEAT] button located on the side panel.
2. Press the [VOL +/-], [◀]/[▶] buttons to select the [M] folder, then press the [MENU/ENTER] button.
3. Press the [VOL +/-] buttons to select the desired Playlist, then press the [MENU/ENTER] button.
4. Press the [PLAY/SPEED ▶] button.
The recorder starts playing the tracks in the sequence specified in the Playlist.

Note:

- The unit will not play the tracks from a Playlist if the Playlist contains an error in the drive name, folder name, file name, etc.

Indicators displayed during playback

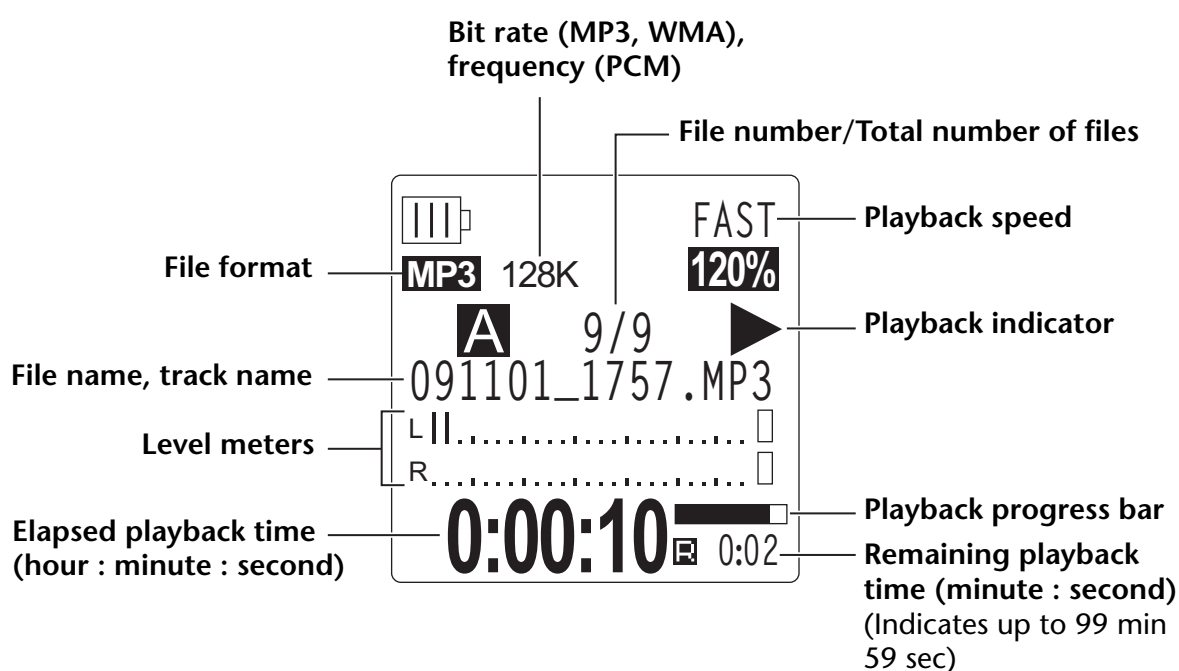

Note:

- With some files, the indicated elapsed playback time may not match the actual elapsed time. Also, the names of certain artists or tracks stored in the unit may not be displayed.

Fast forwarding and fast reversing

■ Fast forwarding and fast reversing

Press and hold down the [▶▶] button for more than one (1) second during playback to fast forward the currently-playing file. Press and hold down the [◀◀] button for more than one (1) second during playback to fast reverse the currently-playing file. Once the unit starts to fast forward or reverse, it will continue doing so even if you release the button. To resume normal playback, press the [PLAY/SPEED ▶] button.

■ Locating the file to play back

Press the [▶▶] button once briefly while the unit is playing or stopped to locate the beginning of the next file.

Press the [◀◀] button once briefly to locate the beginning of the previous file.

■ Locating the index

While the unit is playing back a file that contains index marks, press the [▶▶] button once briefly to skip to the next index mark.

Press the [◀◀] button once briefly to locate the previous index mark.



Hint:

· For information on inserting index marks, refer to [page 43](#).

Using headphones

Use headphones if you do not want sound to be output from the speaker or if the sound from the speaker is difficult to hear. Connect the headphones to the headphones socket located on the side panel of the unit.

You can listen to music through the headphones and achieve your preferred tonal balance by setting the Sound EQ function (see [page 34](#)).

Note:

· The Sound EQ function is effective only for playback through headphones.

5 Playback Settings

Changing the playback speed

You can decrease or increase the playback speed, if necessary. This is useful if you want to listen carefully to complex musical parts or to skip quickly through unimportant parts of a recorded meeting.

1. During playback, press the [PLAY/SPEED ▶] button.
2. The speed indicator flashes. Press the [◀◀]/[▶▶] buttons to select your preferred speed, then press the [MENU/ENTER] button.

Playback speed (FAST)

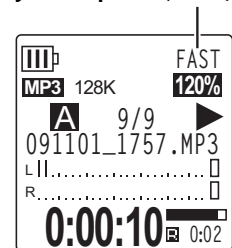

Note:

- If you stop the playback or press the [PLAY/SPEED ▶] button while the speed indicator is flashing, the modified playback speed will be reset to the original setting.

With the [SLOW] option, you can change the speed in 5% steps. With the [FAST] option, you can change the speed in 10% steps. The playback speed varies with the file format as follows:

	PLAY (normal)	SLOW	FAST
MP3	100%	50%–100% (in 5% steps)	100%–200% (in 10% steps)
WMA	100%	50%–100% (in 5% steps)	100%–200% (in 10% steps)
PCM (WAV)	100%	Playback speed cannot be changed.	

The recorder remembers the changed playback speed after the playback is stopped, and will use that speed for the next playback operation. However, the playback speed will be reset to “normal” when the power is turned off.

Note:

- You can change the speed only for playback of MP3 and WMA files. You cannot change the speed for playback of PCM (WAV) files.
- Some files may not play correctly when the playback speed is changed.

Playing back specific sections of a track

You can specify and quickly locate a desired section of a track in three ways. This can be useful if you want to skip unimportant parts during playback or to repeat playback of a particular portion of the file. The recorder features three special playback functions: Skip playback (locating the playback point immediately), A-B Repeat playback (playing a specified part repeatedly), and Phrase playback (moving the playback point back by a specified number of seconds).

Using the Skip playback function

You can skip forward or back by a specific amount of time. This function is useful when you want to locate a desired playback point immediately.

1. During playback, press the [◀◀]/[▶▶] buttons.

Playback will skip ahead or back by the specified amount of time.

Note:

- The playback point will not skip to the next or previous folder. The function is effective only within one folder.
- If the distance between the current point and an index mark or the beginning of the next file is shorter than the distance between the current point and the skip point, the recorder will locate the index mark or the beginning of the next file.

■ Setting the amount of time for Skip playback

1. Press the [MENU/ENTER] button for at least two (2) seconds while the main screen is displayed, select [PLAY MENU] → [SKIP PLAY], then press the [MENU/ENTER] button.



2. Press the [VOL +/-], [◀◀]/[▶▶] buttons to select a skip time value of "10 sec," "30 sec," "1 min," "5 min" or "15 min," then press the [MENU/ENTER] button.

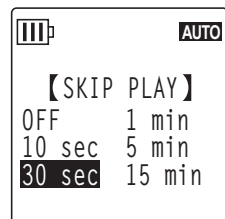

3. Press the [STOP/ESC □] button twice.

The unit displays the main screen.

💡 Hint:

- You can set the skip time value by displaying the menu screen during playback.

Using the A-B Repeat playback function

During playback, you can specify a part of a file that you want to play repeatedly (from point A to point B).

1. During playback, press the [FOLDER/A-B REPEAT] button at the desired start point (A) for A-B Repeat playback.

The start point indicator lights up.

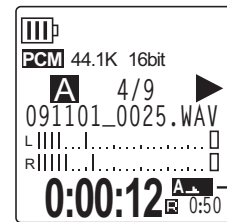



Start point indicator

2. Press the [FOLDER/A-B REPEAT] button at the desired end point (B) for A-B Repeat playback.

The end point is set, and the unit starts playing back the part between A and B repeatedly until you cancel the A-B Repeat function.

To cancel A-B Repeat playback, do one of the following operations during A-B Repeat playback:

- Press the [FOLDER/A-B REPEAT] button again.
- Press the [STOP/ESC ] button.
- Press the []/[] buttons.

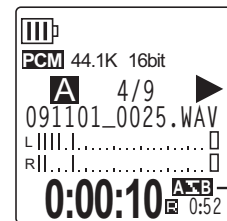

A-B Repeat indicator

Note:

- If the duration between point A and B is too short, you will be unable to set up A-B Repeat playback.
- If you set point A, but not point B, the end of the file will automatically become point B.
- The unit will not perform A-B Repeat playback across files.

Using the Phrase playback function

You can move back the playback point in the currently-playing file by a specified number of seconds. This function is useful if you want to listen again to a short phrase in a piece of music or an important piece of audio.

1. During playback, press the [SCENE/PHRASE] button.

The playback point will move back by the specified number of seconds and playback will resume.

Note:

- During A-B Repeat playback, the Phrase playback function remains effective between points A and B.
- If the specified number of seconds exceeds the time between the current playback point and the beginning of the file, the unit will play back from the beginning of the file.
- The playback point can be moved back to the beginning of the file, but no further. It cannot jump into the previous file.

■ Setting the amount of time for Phrase playback.

1. Press the [MENU/ENTER] button for at least two (2) seconds while the main screen is displayed, select [PLAY MENU] → [PHRASE PLAY], then press the [MENU/ENTER] button.



2. Press the [VOL +/-] buttons to select the amount of time to move back the playback point in a range of 1 sec to 5 sec, in 1 sec(second) steps, then press the [MENU/ENTER] button.

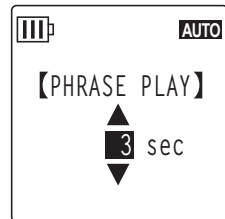

3. Press the [STOP/ESC □] button twice.
The recorder displays the main screen.

Hint:

- You can specify the amount of time for Phrase playback by displaying the menu screen during playback.

Playing back the same track repeatedly

You can play back the same track repeatedly (Repeat playback). The Repeat playback function features various Repeat playback modes, such as playing back the same file repeatedly, playing files in a folder in normal or random sequence, etc.

■ Setting the Repeat playback mode

1. Press the [MENU/ENTER] button for at least two (2) seconds while the main screen is displayed, select [PLAY MENU] → [REPEAT], then press the [MENU/ENTER] button.





2. Press the [VOL +/-] buttons to select a Repeat playback mode from [OFF], [ONE], [ALL] or [RANDOM], then press the [MENU/ENTER] button.



[OFF]	No repeat
[ONE]	Repeats only the currently-selected file.
[ALL]	Repeats all files in the current folder. (The unit will not perform Repeat playback across folders.)
[RANDOM]	Repeats all files in the current folder in random sequence. (The unit will not perform Random playback across folders.)

3. Press the [STOP/ESC □] button twice.
The unit displays the main screen.

During playback, the Repeat mode indicator will appear in the lower right corner of the screen.

	ONE
	ALL
	RANDOM

4. Press the [PLAY/SPEED ▶] button.

The unit will perform the selected Repeat playback.

To cancel Repeat playback, select [OFF] as the Repeat playback mode.

Hint:

- You can select a Repeat playback mode by displaying the menu screen during playback.

Locating a playback position by time (Time Search function)

You can play back a file from a point specified by the time position.

1. Press the [MENU/ENTER] button for at least two (2) seconds while the main screen is displayed, select [PLAY MENU] → [TIME SEARCH], then press the [MENU/ENTER] button.

2. Press the [◀◀]/[▶▶] buttons to select each digit of hour (h), minute (m), or second (s).

Press the [VOL +/-] buttons repeatedly to set the value.

POS: Time position

TOTAL: Duration of the entire file

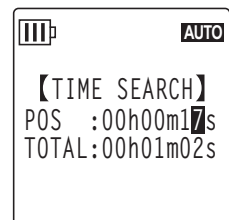

3. Press the [MENU/ENTER] button.

The file will play from the specified time position.

Note:

- You can use the Time Search function only for the currently-selected file.

Setting the sound EQ (equalizer)

You can set the sound EQ to adjust the overall tone of music. The function is available only when you play back files through the headphones.

About the sound EQ options

The recorder offers six sound EQ presets and one USER EQ option (which enables you to cut and boost five bands individually to suit your preference). The sound EQ presets include FLAT, BASS1, BASS2, POP, ROCK and JAZZ.

Features of each sound EQ preset

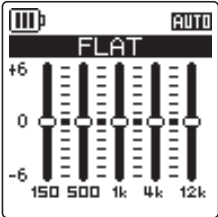
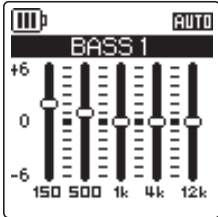
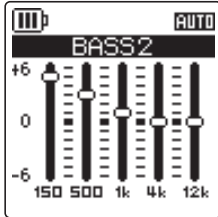
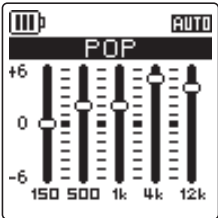
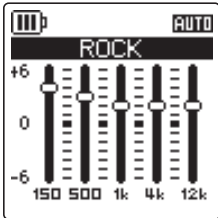
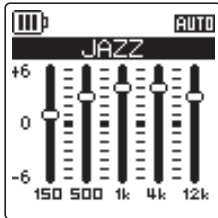
FLAT	BASS1	BASS2
		
No EQ is used. The original sound will be played as is.	This preset mildly boosts the lower frequency range.	This preset significantly boosts the lower frequency range.
POP	ROCK	JAZZ
		
This preset significantly boosts the higher frequency range.	This preset mildly boosts the lower and higher frequency ranges.	This preset boosts the mid frequency range.

Note:

- You cannot change the parameters of the six sound EQ presets. Use the USER EQ option if you wish to adjust the sound EQ to suit your preference.

Selecting a sound EQ option

1. Press the [MENU/ENTER] button for at least two (2) seconds while the main screen is displayed, select [PLAY MENU] → [SOUND EQ], then press the [MENU/ENTER] button.



2. Press the [◀◀]/[▶▶] buttons to select the desired sound EQ option.

Select from six sound EQ presets and one USER EQ option (which enables you to customize the EQ settings).

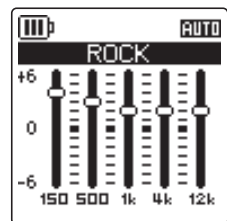

Hint:

- For information on how to customize the USER EQ option, refer to “Customizing the sound EQ option” on [page 36](#).

3. Press the [MENU/ENTER] button.

The selection of the sound EQ option is confirmed.

4. Press the [STOP/ESC □] button twice.

The recorder displays the main screen, including the  indicator.

Hint:

- You can select a sound EQ option by displaying the menu screen during playback.

Customizing the sound EQ option

The USER sound EQ option enables you to adjust the level of five EQ bands.

1. Select "USER" as the sound EQ.

Refer to steps 1 and 2 in the "Selecting a sound EQ option" section on page 35.

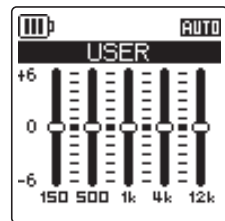

2. Press the [VOL -] button.

The 150Hz band will be selected and displayed as a black bar.

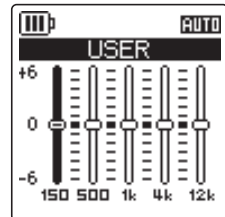

3. Press the [◀◀]/[▶▶] buttons to select the frequency band to cut or boost.

The selected frequency band will be displayed as a black bar.

4. Press the [VOL +/-] buttons to boost or cut the level of the selected frequency band.

You can boost the level by as much as +6dB or cut the level by as much as -6dB in 1dB steps. The larger value will raise the playback level and boost the frequency band.

Note:

- To adjust the level of other frequency bands, repeat steps 3 and 4.
- To cancel the operation, press the [STOP/ESC □] button.

5. Press the [MENU/ENTER] button.

The USER sound EQ option is now customized.

6. Press the [STOP/ESC □] button twice.

The recorder displays the main screen, including the  indicator.

6 Using the Tuner Function

The recorder features a Tuner function that enables you to tune your musical instruments and calibrate the standard pitch (frequency).

Tuning your musical instrument

1. Point the built-in stereo microphone toward the musical instrument you want to tune.

Note:

- To tune an electric guitar or synthesizer, connect the instrument to the recorder's [MIC/LINE] socket.

 For information on how to use the [MIC/LINE] socket, please refer to "Recording from an external audio device (such as a CD player)" on page 10.

2. Press and hold down the [MENU/ENTER] button for at least two (2) seconds while the main screen is displayed, select [TUNER] → [START], then press the [MENU/ENTER] button.

The unit starts analyzing the pitch.

3. The name of the closest note appears in the center of the LCD (in this example, "A"). Tune your musical instrument so that the large black dot (●) appears in the center.

If the pitch is low, "●" appears on the left side. If the pitch is high, "●" appears on the right side.

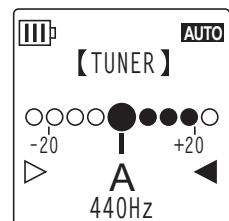

When the instrument is tuned correctly, a white triangle indicator (▷) on each side of the screen turns black (▶) and the LED indicator lights up green.

4. Press the [STOP/ESC ] button to stop tuning.

Note:

- After you start using the Tuning function, if you do not operate the recorder for a duration specified via the Auto Power Off function (see page 60), the Tuning function will automatically stop and power to the unit will turn off.
- While you use the Tuning function, the backlight remains on (unless the backlight setting is "off").

Calibrating the standard pitch

You can calibrate the standard pitch in the range of 430 Hz to 450 Hz in 1 Hz steps. When you purchase the recorder, the standard pitch is set to 440 Hz.

1. Press and hold down the [MENU/ENTER] button for at least two (2) seconds while the main screen is displayed, select [TUNER] → [CALIBRATE], then press the [MENU/ENTER] button.

2. Press the [VOL +/-] buttons repeatedly to set the standard pitch in the range of 430 Hz to 450 Hz, then press the [MENU/ENTER] button.

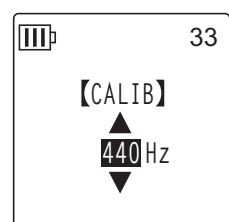

3. Press the [STOP/ESC ] button twice.

The unit displays the main screen.

7 Using the Metronome Function

The recorder features a built-in metronome. The Metronome function enables you to play the metronome, change its tempo and/or beat, and set the metronome so that it will play during recording.

Using the metronome

1. Press and hold down the [MENU/ENTER] button for at least two (2) seconds while the main screen is displayed, select [METRONOME] → [START], then press the [MENU/ENTER] button.

The metronome sound will be output from the speaker and headphones.

2. Press the [STOP/ESC □] button to stop the metronome.
3. Press the [STOP/ESC □] button twice.

The unit displays the main screen.

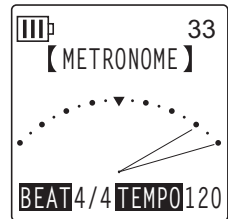

Setting the metronome tempo (speed)

1. Press and hold down the [MENU/ENTER] button for at least two (2) seconds while the main screen is displayed, select [METRONOME] → [TEMPO], then press the [MENU/ENTER] button.



2. Press the [VOL +/-] buttons repeatedly to set the tempo in the range of 30 to 250 bpm, then press the [MENU/ENTER] button.

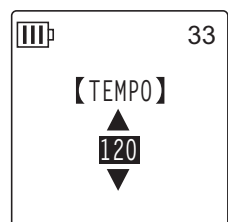

3. Press the [STOP/ESC □] button twice.

The unit displays the main screen.

Note:

- You can also adjust the metronome tempo by pressing the [◀] / [▶] buttons while playing the metronome.

Setting the metronome beats

1. Press and hold down the [MENU/ENTER] button for at least two (2) seconds while the main screen is displayed, select [METRONOME] → [BEAT], then press the [MENU/ENTER] button.



2. Press the [VOL +/-] buttons repeatedly to set the beat in the range of 0/4 to 8/4, then press the [MENU/ENTER] button.

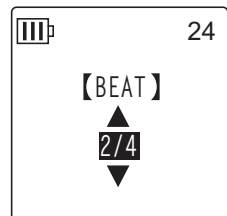

3. Press the [STOP/ESC □] button twice.
The unit displays the main screen.

Playing the metronome during recording

You can record your performance while listening to the metronome via the headphones (the metronome sound will not be output from the speaker). This feature is useful when you are practicing your musical instrument.

1. Press and hold down the [MENU/ENTER] button for at least two (2) seconds while the main screen is displayed, select [METRONOME] → [RECORD], then press the [MENU/ENTER] button.



2. Press the [VOL +/-] buttons to select [ON], then press the [MENU/ENTER] button.

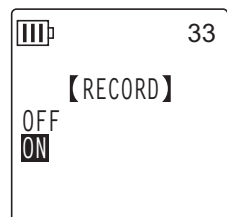

3. Press the [STOP/ESC □] button twice.
The unit displays the main screen. You can now listen to the metronome through the headphones during recording. The metronome sound will not be recorded.

8 Editing Files

Dividing files

You can divide any file recorded and stored in the MIC (A–D) folders or LINE (L) folder into two pieces. This feature enables you to remove an unwanted part of a recording while retaining the part you wish to keep.

⚠ IMPORTANT

Once a file is divided in two, the pieces cannot be rejoined. Be sure to backup important files on a computer or other device before you divide any file.

1. While the main screen is displayed, press the [FOLDER/A-B REPEAT] button located on the side panel.
2. Press the [VOL +/-], [I◀◀]/[▶▶I] buttons to select a folder that contains the file you want to divide, then press the [MENU/ENTER] button.
3. Press the [I◀◀]/[▶▶I] buttons to select the desired file number, then press the [PLAY/SPEED ▶] button.
The recorder starts playing back the file.
4. Press the [STOP/ESC ◻] button at the point at which you wish to divide the file.
The recorder stops playback.
5. Press the [MENU/ENTER] button for at least two (2) seconds while the main screen is displayed, press the [VOL +/-] buttons to select [EDIT MENU] → [DIVIDE], then press the [MENU/ENTER] button.

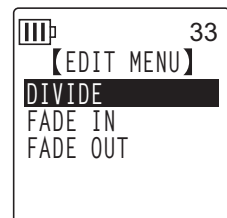

6. Press the [I◀◀]/[▶▶I] buttons to select [YES], then press the [MENU/ENTER] button.
The recorder displays the message "DIVIDING...", then "DIVIDE COMPLETED!" and the file division operation is complete.
When a file is divided, the number of files in the folder increases by one.

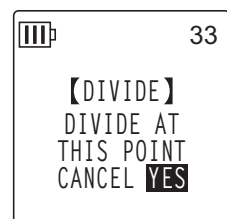

Note:

- You can divide only MP3 or WAV files recorded on the unit.
- If the file length is too short, the unit displays the message "CANNOT DIVIDE! REC TIME TOO SHORT!" and the file will not be divided. This function is not effective on files in the MUSIC (M) and Recycle Bin folders.
- If you divide a file that contains index marks (see page 43), the index marks will be deleted.

■ File names after division

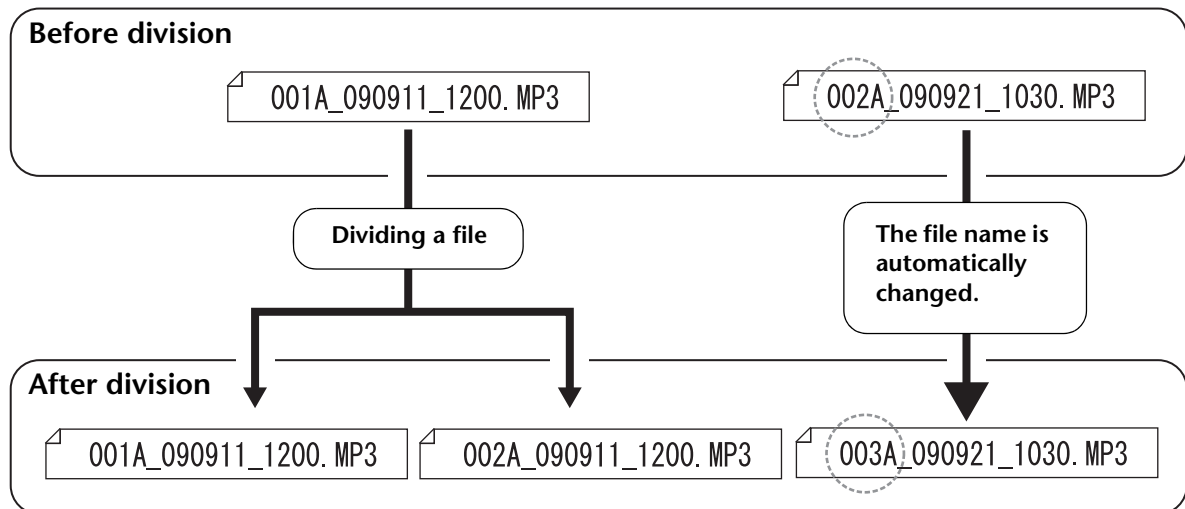

For example, if you divide a file named “001A_090911_1200.MP3”, a new file named “002A_090911_1200.MP3” will be created. If the new file has the same name as a file that already exists in the folder, the new file will keep the name, and the existing file will be renamed automatically.

Note:

- The recorder does not display the file number or the folder type (see [page 70](#)). You can view them only via a connected computer.

■ Overlap time and minimum file length required for division

The two pieces created by a file division overlap each other at the division point as shown in the table below. To be divided successfully, a file must be twice the overlap time or longer in duration.

Recording mode		Overlap time	Required length
MP3	32kbps	About 8 seconds	About 16 seconds or longer
	64kbps	About 4 seconds	About 8 seconds or longer
	128kbps	About 2 seconds	About 4 seconds or longer
	192kbps	About 1 second or shorter	About 2 seconds or longer
	320kbps		
PCM	44.1kHz	About 1 second or shorter	About 2 seconds or longer
	48kHz		
	88.2kHz		
	96kHz		

Using the fade in and fade out effects

The recorder enables you to apply fade in and fade out effects to the files recorded in PCM (WAV) format. The fade in effect raises gradually the volume level of the beginning of the file. The fade out effect reduces gradually the volume level of the end of the file.

⚠ IMPORTANT

Once you apply the fade in/fade out effects, you cannot remove the effect. Be sure to backup important files on a computer or other external device before applying effects.

Applying the fade in effect

1. While the main screen is displayed, press the [FOLDER/A-B REPEAT] button located on the side panel.
2. Press the [VOL +/-], [I◀◀]/[▶▶I] buttons to select a folder that contains the file you want to apply the fade in effect, then press the [MENU/ENTER] button.
3. Press the [I◀◀]/[▶▶I] buttons to select the desired file number.
4. Press the [MENU/ENTER] button for at least two (2) seconds while the main screen is displayed, press the [VOL +/-] buttons to select [EDIT MENU] → [FADE IN], then press the [MENU/ENTER] button.

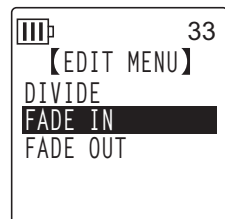

5. Press the [VOL +/-] buttons to select the amount of time to apply fade in effect, then press the [MENU/ENTER] button. You can specify the amount of time in a range of 1 sec to 8 sec (second). The unit displays the message "FADE IN EXECUTING...".

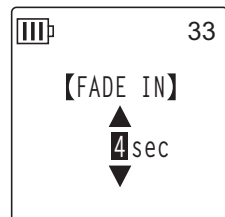

Note:

- If you have selected any file other than a PCM file recorded on the unit, or if you have selected a file of four seconds or less, the unit will display the message "CANNOT FADE IN! FILE TOO SHORT!".

6. When the unit displays "COMPLETED", press the [VOL +/-] buttons to select [AUDITION], then press the [MENU/ENTER] button.

The unit will play back the file with the fade in effect.

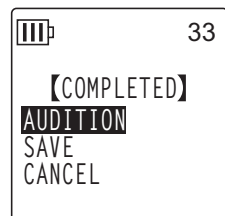

[AUDITION]	You can audition up to about 10 seconds at the beginning of the file with the fade in effect.
[SAVE] (Overwrite)	The file with the fade in effect will be saved. You cannot revert the file to its original status. (That is, you cannot undo the fade in effect.)
[CANCEL]	The fade in effect will not be applied.

- If you are satisfied with the file after auditioning and wish to save it, press the [VOL +/-] buttons to select [SAVE], then press the [MENU/ENTER] button.

The file with the fade in effect will overwrite the original file.

If you do not wish to overwrite the original file, select [CANCEL], then press the [MENU/ENTER] button.

Note:

- If the internal memory (or a microSD card) does not have sufficient free space, you will be unable to apply the fade in and out effects to the file.

Applying the fade out effect

The basic procedure is the same as that for the fade in effect. Please refer to the “Applying the fade in effect” section on page 42. **Please note that you must select [FADE OUT] instead of [FADE IN] in step 4 to apply the fade out effect.**

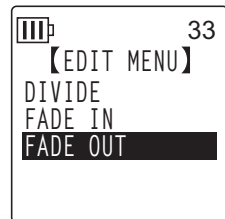

Inserting and deleting index marks

Inserting index marks in a file enables you to locate the playback point immediately during the playback operation. You can insert index marks only in the files in the MIC (A–D) folders.

Inserting index marks

- During recording or playback, press the [LIST/INDEX] button (located on the side panel) at the point where you want to insert an index mark.

The unit displays the message “INDEX SETTING...” and the index mark is inserted.

Note:

- Recording or playback continues after you insert an index mark. Repeat the same steps to continue inserting more index marks in the file, if necessary.
- You can insert up to 36 index marks in each file. If you try to insert more than 36 index marks, the unit displays “INDEX FULL!” and no more index marks will be recorded.
- If you divide a file that contains index marks, the index marks will be deleted.

Deleting index marks

- While the main screen is displayed, press the [FOLDER/A-B REPEAT] button located on the side panel.
- Press the [VOL +/-], [◀]/[▶] buttons to select a folder that contains a file from which you want to delete index marks, then press the [MENU/ENTER] button.
- Press the [◀]/[▶] buttons to select the file from which you want to delete index marks.

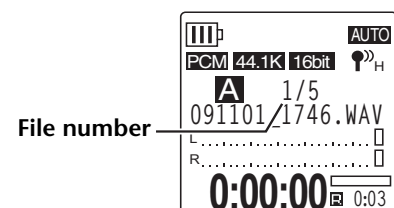

- Press the [DELETE] button located on the side panel.

5. Press the [VOL +/-] buttons to select [INDEX], then press the [MENU/ENTER] button.



6. Press the [I◀◀]/[▶▶I] buttons to select [DELETE], then press the [MENU/ENTER] button.

The unit displays the message "DELETING..." and the index marks are deleted.



Note:

- Deleting index marks will not delete the audio recording.
- You cannot delete index marks individually. All index marks in a file will be deleted.

Using the Playlist function (available only for the MUSIC folder)

The recorder offers five Playlist files P1–5 (PLIST1-5.M3U). You can play back your favorite songs (that are stored in the MUSIC (M) folder) in a preferred sequence by assigning the songs to a Playlist.

Before using the Playlist function, you must transfer audio (track) files to the MUSIC (M) folder using the computer.

- 🔗 [Connecting the recorder to your computer \(page 63\)](#)
- 🔗 [About files and folders \(page 65\)](#)

Assigning the folder and files to a Playlist (P1–5)

1. While the main screen is displayed, press the [FOLDER/A-B REPEAT] button located on the side panel, press the [VOL +/-], [I◀◀]/[▶▶I] buttons to select the [M] folder, then press the [MENU/ENTER] button.
2. Press the [VOL +/-], [I◀◀]/[▶▶I] buttons to highlight the file or folder which you wish to assign to a Playlist, then press the [SCENE/PHRASE] button located on the side panel of the recorder.
3. Press the [I◀◀]/[▶▶I] buttons to select a target Playlist (PLAYLIST1–5), then press the [MENU/ENTER] button.
The folder or the files will be assigned to the selected Playlist.



Note:

- You can assign up to 99 files to each Playlist.
- You cannot delete Playlists (P1–5).
- Do not edit Playlists (P1–5) using the computer. For information on creating a Playlist that you can edit using the computer, please refer to "Playing back tracks in a specific sequence" on [page 77](#).

Changing the playback sequence in a Playlist (P1–5)

1. While the main screen is displayed, press the [FOLDER/A-B REPEAT] button located on the side panel, then press the [VOL +/-], [I◀◀]/[▶▶I] buttons to select one of the folders [P1]–[P5], then press the [MENU/ENTER] button.

The unit displays the track list of the selected Playlist.

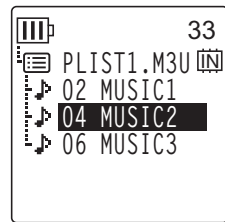

2. Press the [VOL +/-] buttons to select a file whose list position you want to change, then press the [SCENE/PHRASE] button located on the side panel.
3. Press the [VOL +/-] buttons to select [ORDER], then press the [MENU/ENTER] button.



4. Press the [VOL +/-] buttons to move the selected file to the preferred position in the playback list.

The indicator of the selected file changes to "➡".

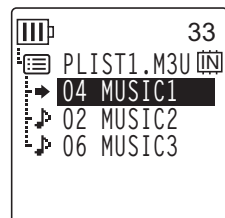

5. Press the [MENU/ENTER] button.

The order of the files in the Playlist is changed.

Removing a file from a Playlist (P1–5)

You can remove a file from a Playlist. Removing a file from a Playlist will not delete the original file.

1. While the main screen is displayed, press the [FOLDER/A-B REPEAT] button located on the side panel, then press the [VOL +/-], [I◀◀]/[▶▶I] buttons to select one of the folders [P1]–[P5], then press the [MENU/ENTER] button.

The unit displays the track list of the selected Playlist.

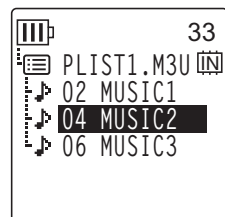

2. Press the [VOL +/-] buttons to highlight a file you wish to remove from the Playlist, then press the [SCENE/PHRASE] button located on the side panel.
3. Press the [VOL +/-] buttons to select [DELETE], then press the [MENU/ENTER] button.



4. Press the [I◀◀]/[▶▶I] buttons to select [DELETE], then press the [MENU/ENTER] button.

The selected file will be removed from the Playlist.

Removing all files from a Playlist (P1–5)

You can remove all files from a Playlist. Removing all files from a Playlist will not delete the original files.

1. While the main screen is displayed, press the [FOLDER/A-B REPEAT] button located on the side panel, then press the [VOL +/-], [I◀◀]/[▶▶I] buttons to select one of the folders [P1]–[P5], then press the [MENU/ENTER] button.

The unit displays the track list of the selected Playlist.

2. Press the [SCENE/PHRASE] button located on the side panel.
3. Press the [VOL +/-] buttons to select [DELETE PLAYLIST], then press the [MENU/ENTER] button.

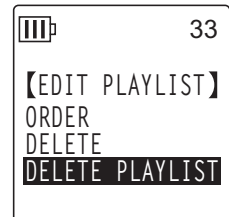

4. Press the [I◀◀]/[▶▶I] buttons to select [DELETE], then press the [MENU/ENTER] button.

All files are removed from the Playlist, and the unit displays “No File” on the LCD.



9 Deleting

Managing the Recycle Bin

If you delete a file on the recorder while the Recycle Bin function is active, the file will be moved to the Recycle Bin () folder temporarily so that you can restore it later if necessary. If you delete a file or folder on the recorder while the Recycle Bin function is turned off, the file will be deleted completely and you will be unable to restore it. It is recommended that you turn the Recycle Bin function on to avoid accidental erasure.

When the Recycle Bin is full, you must empty it to increase the remaining recording time. Otherwise, you may be unable to record. Empty the Recycle Bin regularly.

Note:

- The Recycle Bin folder can accommodate up to 199 files. If the Recycle Bin folder is full and you cannot move any more files to the Recycle Bin, move some files from the Recycle Bin folder to the original folder (see [page 49](#)) or empty the Recycle Bin folder (see [page 50](#)).

Activating the Recycle Bin function

1. Press the [MENU/ENTER] button for at least two (2) seconds while the main screen is displayed, press the [VOL +/-] buttons to select [COMMON MENU] → [RECYCLE BIN] → [ON], then press the [MENU/ENTER] button.

The Recycle Bin function is turned on.



2. Press the [STOP/ESC ] button twice to go back to the main screen.

Note:

- You can move files to the Recycle Bin folder only from the MIC (A–D) folders and LINE (L) folder. You cannot move files from the MUSIC (M) folder to the Recycle Bin folder, regardless of whether the Recycle Bin function is on or off. These files will be deleted completely by the delete operation.
- If you initialize the internal memory or a microSD card, all files on the internal memory or microSD card, respectively, will be deleted (and will not be moved to the Recycle Bin folder). All files previously moved from the card to the Recycle Bin folder will also be deleted.
- If the Recycle Bin function is active, deleting the files will not increase the available recording time.

Displaying the Recycle Bin folder

While the main screen is displayed, press the [FOLDER/A-B REPEAT] button located on the side panel, then press the [VOL +/-], [◀]/[▶] buttons to select the Recycle Bin (🗑️) folder, and then press the [MENU/ENTER] button.

- The Recycle Bin folder contains no files.
- The Recycle Bin folder contains files.

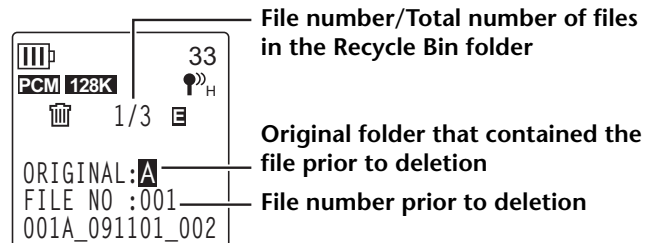
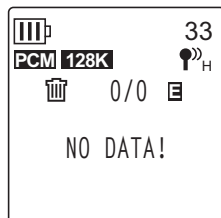

The files moved into the Recycle Bin will be renamed automatically (see [page 70](#)).

Playing back a file in the Recycle Bin folder

1. While the main screen is displayed, press the [FOLDER/A-B REPEAT] button located on the side panel.
2. Press the [VOL +/-], [◀]/[▶] buttons to select the Recycle Bin (🗑️), then press the [MENU/ENTER] button.
3. Press the [◀]/[▶] buttons to select the desired file to play, then press the [PLAY/SPEED ▶] button.

The selected file will play.



Restoring a file from the Recycle Bin folder

1. While the main screen is displayed, press the [FOLDER/A-B REPEAT] button located on the side panel.
2. Press the [VOL +/-], [◀]/[▶] buttons to select the Recycle Bin (🗑️), then press the [MENU/ENTER] button.
3. Press the [◀]/[▶] buttons to select the desired file to restore, then press the [DELETE] button located on the side panel.

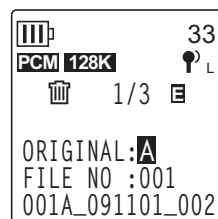

4. Press the [VOL +/-] buttons to select [RESTORE 1 FILE], then press the [MENU/ENTER] button.



5. Press the [◀]/[▶] buttons to select [RESTORE], then press the [MENU/ENTER] button.

The recorder will display the message "RESTORING...", then "RESTORED TO THE BOTTOM OF A" (if the file previously belonged to folder A), and the file will move back to its original folder.

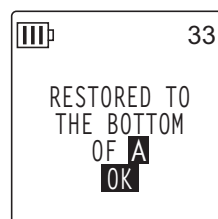

Note:

- A file restored from the Recycle Bin will be renamed automatically and added to the end of the file list in the original folder (see [page 70](#)).
- If the recorder displays the message "FOLDER FULL!," the original folder contains the maximum number of files allowed. In this case, delete some files to clear some space.

6. Press the [MENU/ENTER] button again.

The recorder displays the main screen.

Emptying the Recycle Bin folder

1. While the main screen is displayed, press the [FOLDER/A-B REPEAT] button located on the side panel.
2. Press the [VOL +/-], [I◀◀]/[▶▶I] buttons to select the Recycle Bin (🗑️), then press the [MENU/ENTER] button.
3. Press the [DELETE] button located on the side panel.
4. Press the [VOL +/-] buttons to select [EMPTY], then press the [MENU/ENTER] button.



⚠️ Caution

- Emptying the Recycle Bin will permanently delete all files in the Recycle Bin and the same files from the internal memory or the microSD card. You will be unable to restore those files. Be sure to backup important files on a computer or other external device before emptying the Recycle Bin.

5. Press the [I◀◀]/[▶▶I] buttons to select [EMPTY], then press the [MENU/ENTER] button.



The recorder displays the message "EMPTYING...", then "NO DATA!", and the Recycle Bin is emptied.

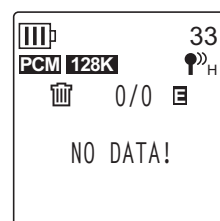

⚠️ IMPORTANT

- If the Recycle Bin folder contains many files, the recorder's operation may slow down. Empty the Recycle Bin regularly.

Deleting a selected file

You can delete a single file from a folder.

⚠ Caution

- If you delete a file while the Recycle Bin function is turned off (*see page 47*), you will be unable to restore it. Be sure to check the content of a file before you delete it.
- Before you proceed, make sure that the battery power is sufficient.

1. While the main screen is displayed, press the [FOLDER/A-B REPEAT] button located on the side panel.
2. Press the [VOL +/-], [◀]/[▶] buttons to select a folder from which to delete a file, then press the [MENU/ENTER] button.
3. Press the [◀]/[▶] buttons to select a file to delete, then press the [DELETE] button located on the side panel.
4. Press the [VOL +/-] buttons to select [FILE], then press the [MENU/ENTER] button.



5. When the [DELETE FILE] screen is displayed, press the [◀]/[▶] buttons to select [DELETE], then press the [MENU/ENTER] button.

The unit displays the message "DELETING..." and the file is deleted.

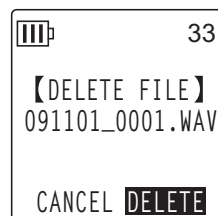

Note:

- If you decide not to execute the delete operation, select [CANCEL], then press the [MENU/ENTER] button.
- You cannot cancel the delete operation if the recorder has already started the operation.

If the Recycle Bin function is active, the file will move to the Recycle Bin. When the recorder displays "MOVED TO RECYCLE BIN," select [OK], then press the [MENU/ENTER] button.



Note:

- If the recorder displays the message "RECYCLE BIN FULL!," the Recycle Bin folder is full. Empty the Recycle Bin, then delete the file.

Deleting all files from a folder

You can delete all files from a selected folder.

Caution

- *If you delete all files from the selected folder while the Recycle Bin function is turned off (see [page 47](#)), you will be unable to restore them. Be sure to check the contents of a folder before you delete the files.*
 - *Before you proceed, make sure that the battery power is sufficient.*
-

The procedure is similar to that for deleting a file. Please refer to the “Deleting a selected file” section on [page 51](#). **Please note that you must select [FOLDER] instead of [FILE] in step 4 to delete all files from the folder.**

Note:

- *You cannot delete any sub-folders in the MUSIC (M) folder (see [pages 67 and 69](#)) by using this function. To delete these sub-folders, connect the recorder to a computer and delete the sub-folders by using the computer.*
-

Formatting the internal memory/a microSD card (Deleting all data)

Formatting the internal memory or a microSD card will delete all files on the internal memory or microSD card, respectively, regardless of whether the Recycle Bin function is turned on or off.

You must also format a commercially available microSD card before you use the card for the first time.

⚠ Caution

- If you delete files from the internal memory or the microSD card, you will be unable to restore those files. Be sure to check the file contents before you delete a file.
- Be sure to backup important files on a computer or other external device.
- Before you proceed, make sure that the battery power is sufficient.

1. Press the [MENU/ENTER] button for at least two (2) seconds while the main screen is displayed, press the [VOL +/-] buttons to select [COMMON MENU] → [FORMAT], then press the [MENU/ENTER] button.



2. Press the [VOL +/-] buttons to select [INTERNAL MEMORY] or [microSD CARD], then press the [MENU/ENTER] button.

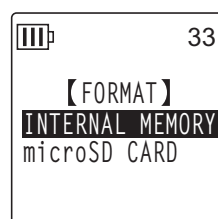

3. Press the [◀◀]/[▶▶] buttons to select [FORMAT], then press the [MENU/ENTER] button.

The unit displays the message "FORMATTING...", then "FORMAT COMPLETED!", and all data is deleted from the internal memory (or the microSD card).

Note:

- If you decide not to execute the operation, select [CANCEL], then press the [MENU/ENTER] button.
- You cannot cancel the formatting operation if the recorder has already started the operation.

4. Press the [STOP/ESC □] button twice.

The recorder displays the main screen.

10 Using the Timer Function

Programming a timer

The Timer function enables you to set the recorder so that it will start a microphone recording or play a file or an alarm at a specified time. Before you program a timer, make sure that the date and time on the unit have been set correctly (see [page 58](#)).

1. Press and hold down the [MENU/ENTER] button for at least two (2) seconds while the main screen is displayed, press the [VOL +/-] buttons to select [COMMON MENU] → [TIMER & ALARM], then press the [MENU/ENTER] button.



2. Press the [VOL +/-] buttons to select a setting item, then press the [MENU/ENTER] button.

The unit displays the setting screen for the selected item. For details about each setting item, see [pages 54–57](#).

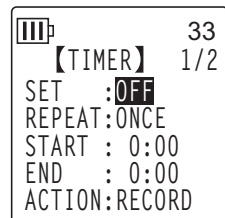

■ SET

Press the [VOL +/-] buttons to highlight [ON] or [OFF], then press the [MENU/ENTER] button.

- OFF:** The Timer function is disabled.
- ON:** The Timer function is enabled.

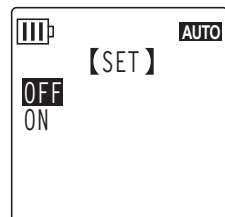

■ REPEAT

Press the [VOL +/-] buttons to highlight [ONCE], [DAILY] or [WEEKLY], then press the [MENU/ENTER] button.

- ONCE:** The recorder will automatically record or play back once at the programmed time.
- DAILY:** The recorder will automatically record or play back every day at the programmed time.
- WEEKLY:** The recorder will automatically record or play back at the programmed time on the programmed day of the week.

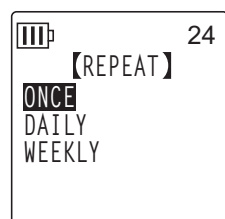

■ Setting the WEEKLY timer (Available only when [WEEKLY] REPEAT is selected)

1. Press the [VOL +/-], [I◀◀]/[▶▶I] buttons to highlight a day of the week, then press the [MENU/ENTER] button to check the corresponding box.

SUN: Sunday; MON: Monday; TUE: Tuesday; WED: Wednesday;
THU: Thursday; FRI: Friday; SAT: Saturday; STORE: Confirm

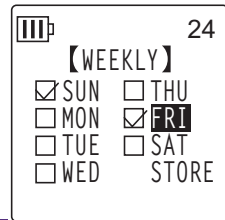

Note:

- You can select multiple days of the week.

2. Press the [VOL +/-], [I◀◀]/[▶▶I] buttons to highlight [STORE] (Confirm), then press the [MENU/ENTER] button.

■ Setting the START time

Press the [I◀◀]/[▶▶I] buttons to highlight the hour or minute digit, use the [VOL +/-] button to set the value, then press the [MENU/ENTER] button.



■ Setting the END time

Press the [I◀◀]/[▶▶I] buttons to highlight the hour or minute digit, use the [VOL +/-] button to set the value, then press the [MENU/ENTER] button.

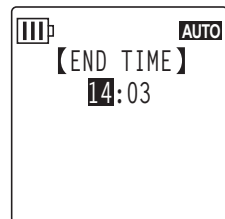

Note:

- You can set up to 12 hours for the programmed time duration from start to end time.

■ Setting the ACTION

Press the [VOL +/-] buttons to select [PLAY] or [RECORD], then press the [MENU/ENTER] button.

PLAY: The unit starts playback at the programmed time.

RECORD: The unit starts recording at the programmed time.



■ Setting the playback SOURCE (Available only when [PLAY] is selected for ACTION)

1. Press the [VOL +/-] buttons to select [BEEP] (to play a beep sound) or [FILE] (to play a file).

BEEP: The unit plays a beep sound.

FILE: The selected file will play.

When you select "FILE," the unit displays the list screen. Select a file to play (excluding files in Playlists or in the Recycle Bin).

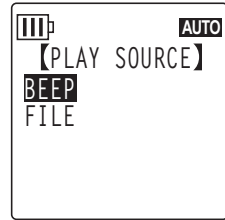

Note:

- To toggle between the internal memory and a microSD card, press and hold down the [FOLDER/A-B REPEAT] button for at least two (2) seconds while the list screen is displayed.

2. Press the [VOL +/-], [I◀◀]/[▶▶I] buttons to select [STORE] (Confirm), then press the [MENU/ENTER] button.

■ Setting the REC MODE (sound quality) (Available only when [RECORD] is selected for ACTION)

Press the [VOL +/-], [I◀◀]/[▶▶I] buttons to select a Recording mode option, then press the [MENU/ENTER] button.

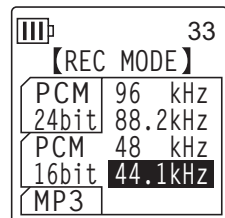

■ Setting the recording destination FOLDER (Available only when [RECORD] is selected for ACTION)

Press the [VOL +/-], [I◀◀]/[▶▶I] buttons to select a folder to which to record a file, then press the [MENU/ENTER] button.

If you wish to record to the card folder MIC_A_SD–MIC_D_SD, you must first insert a microSD card in the recorder.

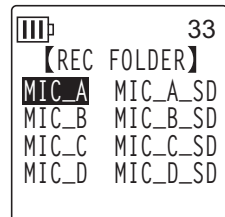

■ Completing the timer settings

1. Press the [VOL +/-] buttons to select [STORE], then press the [MENU/ENTER] button.

The programmed timer settings are confirmed, and the unit displays the [COMMON MENU] screen.

2. Press the [STOP/ESC ] button twice.

The unit displays the main screen.

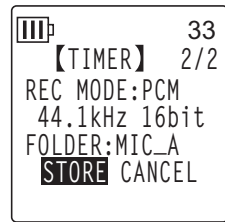

Note:

- Initializing the calendar (date and time) will reset all timer settings to "OFF."
- The timer recording (or playback) may fail under the following circumstances:
 - The internal memory (or microSD card) does not have sufficient memory space for the specified duration of the timer recording.
 - The file (for playback) or the folder (for recording) in the microSD card has been specified, but the microSD card has not been inserted in the recorder.
 - You attempted to program a timer recording that would cause the maximum number of recordable files (199) to be exceeded.
 - The recorder is connected to the computer, and is unable to start the timer operation at the programmed time.
 - The battery is exhausted or the power to the unit turned off during the timer recording (or playback).
- If the timer fails for some reason, one of the following will occur:
 - If a REPEAT [ONCE] timer recording fails, the timer will be turned off.
 - If a REPEAT [DAILY] or [WEEKLY] timer recording fails, the timer will remain on.

11 Preference Settings

You can set the preference settings to make it easier to use the recorder in various environments and circumstances.

Setting the current date and time

After you set the date and time, the recorder will automatically record the time and date of recording with each file. Since the name of recorded files includes the recording date and time, Yamaha recommends that you set the date and time accurately.

1. Press the [MENU/ENTER] button for at least two (2) seconds while the main screen is displayed, press the [VOL +/-] buttons to select [COMMON MENU], then press the [MENU/ENTER] button.

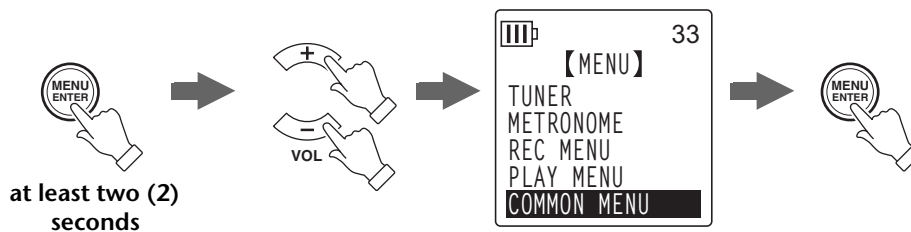

2. Press the [VOL +/-] buttons to select [DATE & TIME], then press the [MENU/ENTER] button.

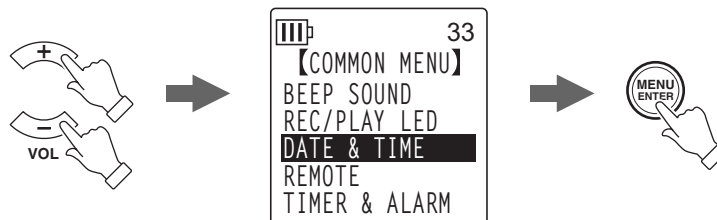

3. Press the [VOL +/-] buttons to select the year, then press the [▶▶] button.

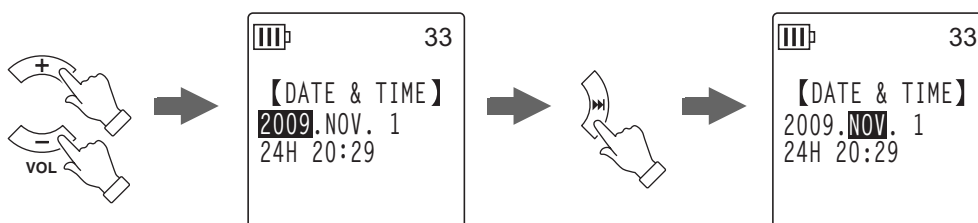

4. In the same way, select the month, day, 24/12-hour indication (24H or AM/PM), hour and minute, then press the [MENU/ENTER] button.

5. Press the [STOP/ESC □] button twice.

The recorder displays the main screen.

Setting the beep sound

You can set the recorder so that it will make a beep sound when you operate the buttons or if you make an operational error.

1. Press the [MENU/ENTER] button for at least two (2) seconds while the main screen is displayed, press the [VOL +/-] buttons to select [COMMON MENU] → [BEEP SOUND], then press the [MENU/ENTER] button.

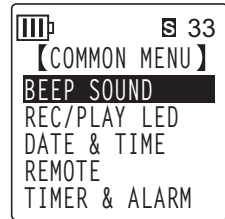

2. Press the [VOL +/-] buttons to select [ON], then press the [MENU/ENTER] button.

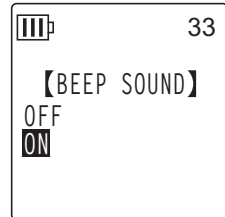

3. Press the [VOL +/-] buttons to select the desired volume option, then press the [MENU/ENTER] button.

To cancel the beep sound, select [OFF] in step 2.

- HIGH:** High volume
MIDDLE: Medium volume
LOW: Low volume

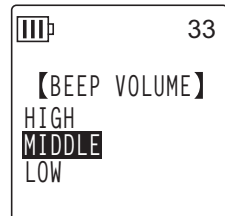

Settings related to remote control operation

You can set the recorder so that the supplied remote control will be locked (disabled). You can also set the recorder so that the LED indicator will flash green when the recorder receives a signal from the remote control.

1. Press the [MENU/ENTER] button for at least two (2) seconds while the main screen is displayed, press the [VOL +/-] buttons to select [COMMON MENU] → [REMOTE], then press the [MENU/ENTER] button.

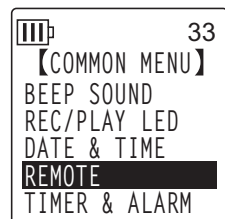

Locking (disabling) remote control operation:

2. Press the [VOL +/-] buttons to select [REMOTE LOCK], then press the [MENU/ENTER] button.
3. Press the [VOL +/-] buttons to select [LOCK], then press the [MENU/ENTER] button.

To unlock (enable) the remote control, select [REMOTE ON].

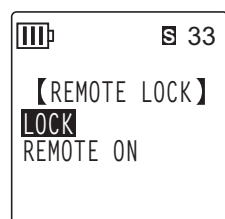

Flashing the recorder's LED indicator:

You can set the recorder so that its recording/playback LED indicator (located in the upper part of the recorder) will flash green when the recorder receives a signal from the remote control.

After flashing green for a few seconds, the LED indicator will light up steadily or turn off, depending on the [REC/PLAY LED] setting, as explained in the "Changing the LED setting" on [page 25](#).

2. Press the [VOL +/-] buttons to select [LED], then press the [MENU/ENTER] button.

3. Press the [VOL +/-] buttons to select [ON], then press the [MENU/ENTER] button.

To make the LED indicator not flash green, select [OFF].

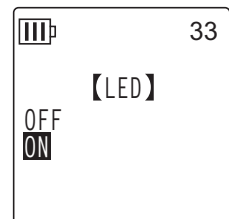

Activating the Auto Power Off function

If this function is turned on, and you leave the recorder turned on but unused for a specified duration, the recorder will automatically turn off (except during recording, VAS recording standby mode, playback or metronome operation).

1. Press the [MENU/ENTER] button for at least two (2) seconds while the main screen is displayed, press the [VOL +/-] buttons to select [COMMON MENU] → [AUTO OFF], then press the [MENU/ENTER] button.

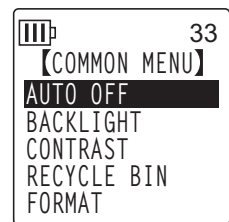

2. Press the [◀◀]/[▶▶] buttons to select the desired time to function the Auto Power Off, then press the [MENU/ENTER] button.

0 (OFF)–15 (15 min.)

You can specify the time in 1 minute steps.

To cancel the Auto Power Off function, specify [0](OFF).

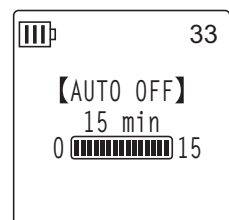

Setting the Backlight function

When the Backlight function is turned on, the LCD backlight lights up each time you press a button or switch on the unit.

1. Press the [MENU/ENTER] button for at least two (2) seconds while the main screen is displayed, press the [VOL +/-] buttons to select [COMMON MENU] → [BACKLIGHT], then press the [MENU/ENTER] button.

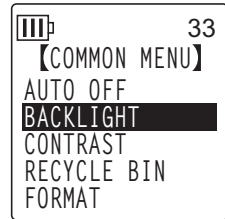

2. Press the [VOL +/-] buttons to select the desired time to light up the backlight, then press the [MENU/ENTER] button.

- OFF:** The backlight will not light up.
5 sec: The backlight lights up for five seconds.
15 sec: The backlight lights up for 15 seconds.
ALWAYS ON: The backlight remains lit all the time.



Note:

- If the battery power is insufficient, the backlight will not light up.

Adjusting the LCD contrast

You can adjust the LCD contrast on a scale of ten (10).

1. Press the [MENU/ENTER] button for at least two (2) seconds while the main screen is displayed, press the [VOL +/-] buttons to select [COMMON MENU] → [CONTRAST], then press the [MENU/ENTER] button.



2. Press the [◀◀]/[▶▶] buttons to adjust the contrast, then press the [MENU/ENTER] button.

L (low): 1–H (high): 10

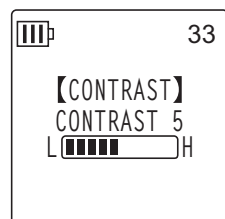

Initializing the menu settings

Initializing the recorder settings will restore all menu settings (excluding the date and time setting) to the factory default.

Note:

- Initializing the recorder settings will not delete any data on the internal memory or microSD card. For information on initializing the internal memory or a microSD card, refer to [page 53](#).

Procedure:

Press the [MENU/ENTER] button for at least two (2) seconds while the main screen is displayed, press the [VOL +/-] buttons to select [COMMON MENU] → [MENU RESET] → [YES], then press the [MENU/ENTER] button.

If you decide not to initialize the settings, select [CANCEL].

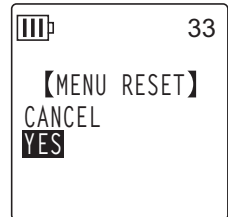

Checking the firmware version

You can check the version number of the recorder's firmware by following the procedure below.

Procedure:

Press the [MENU/ENTER] button for at least two (2) seconds while the main screen is displayed, press the [VOL +/-] buttons to select [COMMON MENU] → [VERSION], then press the [MENU/ENTER] button.

The firmware version will be displayed.



12 Using the Recorder with a Computer

You can transfer audio files stored on the internal memory or microSD card to a computer by connecting the recorder to the computer via an included USB cable. Transferred files are compatible for playback with Windows Media Player and iTunes, and can be edited using the included “Cubase AI” DAW software. You can also transfer audio files from a computer to the recorder for playback.

Computer system requirements

■ Windows

Computer: Windows-based computer with built-in USB interface

OS: Windows 7, Vista, XP Professional/Home Edition

■ Macintosh

Computer: Macintosh computer with built-in USB interface

OS: Mac OS X 10.4, 10.5, 10.6

Note:

- Please visit the website below for the latest information on included software and system requirements.
<http://www.yamahasynth.com/>
- The menu items and buttons displayed on your computer may not exactly match those shown in this manual, depending on the OS version of your computer. This manual uses Windows XP and Windows Media Player 11 as examples.

Connecting the recorder to your computer

1. Start the computer.
2. Make sure that the recorder is turned off, and then connect the included USB cable.

IMPORTANT

Use only the USB cable included with the recorder. The use of an improper cable may damage the terminal and result in a malfunction.

Disconnecting the recorder from your computer

■ Windows:

1. Click  on the taskbar at the bottom right of the Windows screen, then click [Safely remove USB Mass Storage Device].
2. After the computer displays the message shown on the right, remove the USB cable.



■ Macintosh:

1. Drag and drop the drive icon [PRW24] or [PRW24SD] of the recorder on the desktop to the Trash Can.
2. After the drive icon [PRW24] or [PRW24SD] disappears from the desktop, remove the USB cable.

Troubleshooting (Windows Vista/XP)

If the recorder is not recognized by the computer, refer to the information below:

■ Windows Vista

While the recorder remains connected to the computer, follow the steps below:

1. From the [Start] menu, right-click [Computer] to display the pop-up menu, then select [Properties] to open the "System" window.
2. Click [Device Manager] to open the user account control window. In this window, click [Continue] to open the "Device Manager" window.
3. Expand "Disk drives" and "Universal Serial Bus controllers." "Disk drives" must include "Yamaha Pocketrak USB Device", "Yamaha Pocketrak SD USB Device", and "Universal Serial Bus controllers" must include the device name for the USB Mass Storage Device.

■ Windows XP

While the recorder remains connected to the computer, follow the steps below:

1. From the [Start] menu or on the desktop, right-click [My Computer] to display the pop-up menu, then select [Properties] to open the "System Property" window.
2. Click the [Hardware] tab, then click [Device Manager] to open the "Device Manager" window.
3. Expand "Disk drives" and "Universal Serial Bus controllers." "Disk drives" must include "Yamaha Pocketrak USB Device", "Yamaha Pocketrak SD USB Device", and the "Universal Serial Bus controllers" must include the device name for the USB Mass Storage Device.

If the “Device Manager” window does not display the correct items:

Follow the steps below.

1. Exit (quit) all running applications.
2. Disconnect all external USB devices (excluding a properly working mouse and keyboard), then connect only the recorder.
3. If the computer features multiple USB terminals, use a different USB terminal to connect the recorder.
4. If the recorder is connected via a bus-powered USB hub, remove the hub, then use the included USB cable to connect the recorder directly to the computer’s USB terminal.

About files and folders

From a connected computer, you can manage the recorder’s files that are stored in folders. You can also transfer audio files from the recorder to a computer to save them, or from a computer to the recorder for playback.

1. Connect the recorder to the computer.
2. Click to open [My Computer] from the [start] menu.



- The unit displays [PRW24] as the drive name of the recorder’s internal memory.
- If you have formatted a microSD card on the recorder, the drive name of the card inserted in the unit appears as [PRW24SD]. If the microSD card inserted in the unit was not formatted on the recorder, or if a microSD card has not been inserted in the unit, the unit displays [Removable Disk] as the drive name.

3. Double-click to open [PRW24] or [PRW24SD].

The system displays the recorder's folders.

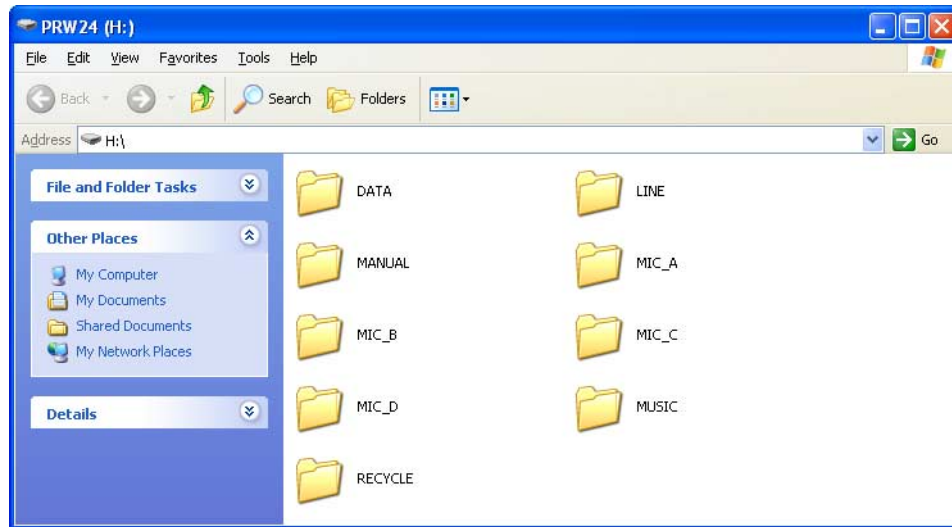

Note:

- If the system displays the "What do you want Windows to do?" panel, click to select [Open folder to view files], then click [OK]. The system will display the recorder's folders.



■ Files are stored in the following folders on the internal memory or microSD card.

- MIC(A–D) / MIC_(A–D)_SD

These folders store audio files (in MP3 or WAV format) recorded by the unit.

Note:

- Do not move the files to a different folder. For example, do not move a file in the A folder to the B folder. Otherwise, you will be unable to play the file.
- Also, please note that if you change the name of an MP3 or WAV file (originally recorded on the unit) on the computer, then move the file back to the MIC (A–D) folder, you will be unable to play the file on the unit. To play the file, first rename the file following the file naming rules, or move the file to the MUSIC (M) folder (see [page 70](#)).

- MUSIC

This folder stores music and other audio files transferred from a connected computer. To play the transferred files, the files must be in MP3 or WMA format or WAV files that were recorded on the unit. There are no naming rules that apply to these files.

The recorder offers five Playlist files (PLIST1–5.M3U). You can play your favorite songs in your preferred order by creating Playlists using the files stored in the MUSIC folder (see [page 44](#)).

Note:

- Files in each folder are automatically sorted numerically in ascending order based on the number that appears at the start of each file name. If the number of digits varies (e.g., "001xxxxx", "01xxxxxx", and "1xxxxxxx"), files will be sorted in the following order: "001xxxxx", "01xxxxxx", then "1xxxxxxx".

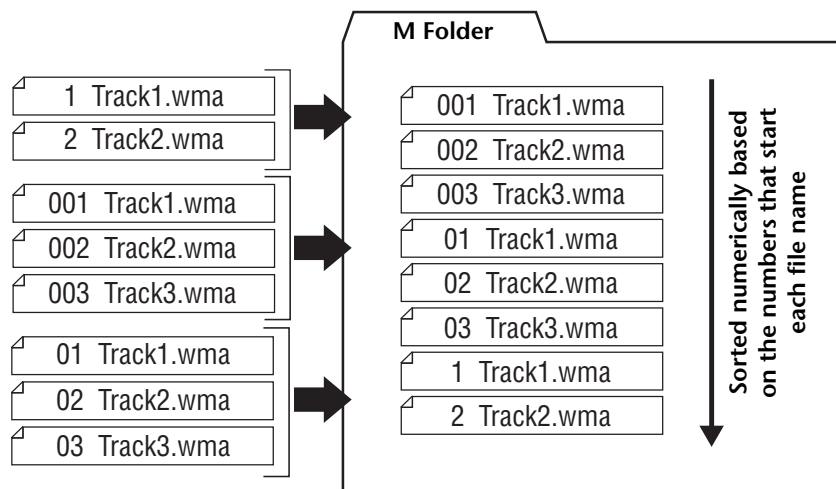

- You can create sub-folders (in up to two hierarchies) inside the MUSIC folder to organize the music files by albums or musicians (see [page 69](#)).
- Please note that if the MUSIC (M) folder contains a file with the same name as that of the audio file you are transferring from a computer, the file in the MUSIC folder will be overwritten by the one transferred from the computer.

- **DATA**

This folder stores data files (of MS Excel, MS Word, etc.) and enables you to use the recorder as a USB flash drive or a microSD card reader/writer (removable disk).

Note: _____

- *The recorder will not play any audio or music files that are placed in this folder.*
 - *This folder will be recognized only by a connected computer. The recorder will not display this folder on its screen.*
-

- **LINE(L) / LINE(L)_SD**

This folder stores files recorded from external devices via the line connection.

Please note that if you change the name of an MP3 file (originally recorded on the unit) on the computer, then move the file back to the LINE (L) folder, you will be unable to play the file on the unit. To play the file, first rename the file following the file naming rules, or move the file to the MUSIC (M) folder (see [page 70](#)).

- **RECYCLE**

This is the Recycle Bin folder. While the Recycle Bin function is active, files deleted on the recorder will move to this folder. You can restore files from the Recycle Bin folder, which can be a life saver if you delete a file accidentally.

- **MANUAL**

This folder stores the Owner's Manual and Reference Manual in PDF format. These manuals are organized into the sub-folders by language.

If you initialize the recorder's internal memory, the MANUAL folder will also be erased. If necessary, you can download the manuals from the following website:

<http://www.yamahasynth.com/>

Note: _____

- *This folder will be recognized only by a connected computer. The recorder will not display this folder on its screen.*
-

POCKETRAK W24 folder structure

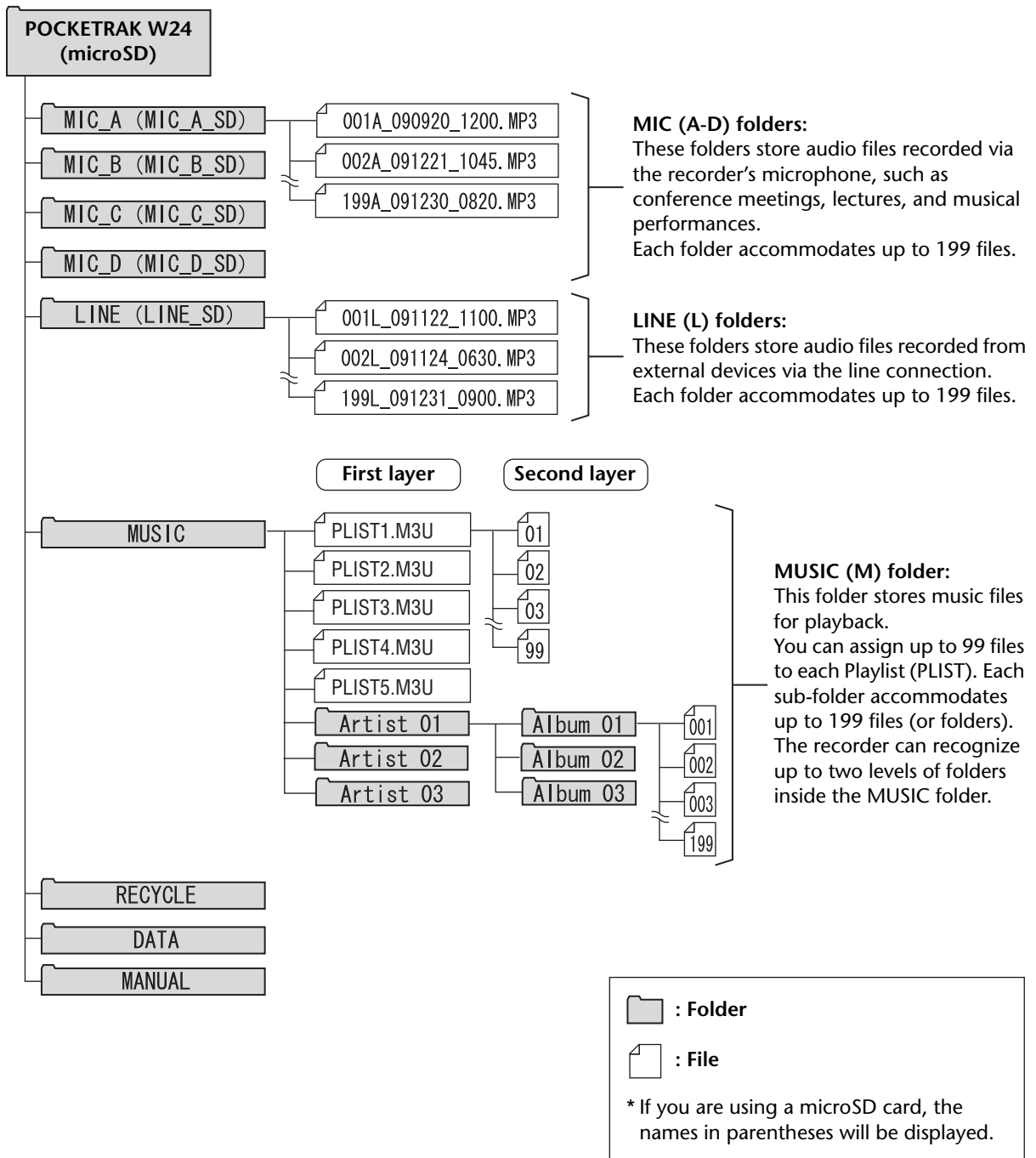

MIC (A-D) folders:
 These folders store audio files recorded via the recorder's microphone, such as conference meetings, lectures, and musical performances. Each folder accommodates up to 199 files.

LINE (L) folders:
 These folders store audio files recorded from external devices via the line connection. Each folder accommodates up to 199 files.

MUSIC (M) folder:
 This folder stores music files for playback. You can assign up to 99 files to each Playlist (PLIST). Each sub-folder accommodates up to 199 files (or folders). The recorder can recognize up to two levels of folders inside the MUSIC folder.

: Folder

: File

* If you are using a microSD card, the names in parentheses will be displayed.

About the file naming rules

The recorder automatically names the recorded files, following the file naming rules as shown below. The recorder does not display the file number and the folder type. You can view them only via a connected computer.

001A_091121_1200.MP3

① ② ③ ④ ⑤

- ① File number (001–199)
- ② Folder type (A–D: MIC folders A–D, L: LINE folder)
- ③ Recording date (Year, Month, Day: Date of the file recording)
- ④ Recording time (Hour, Minute: Start time of the file recording)
- ⑤ Extension (File format: MP3 for an MP3 recording file, and WAV for a PCM recording file)

Files moved into the Recycle Bin will be renamed as follows:

Example: Moving file “001A_091121_1200.MP3” in the MIC_A folder into the Recycle Bin

001_001A_091121_1200.MP3

① ② ③ ④ ⑤ ⑥

- ① File number used in the Recycle Bin (Each file will be numbered sequentially based on when the file was moved to the Recycle Bin [e.g., 001, 002, 003, etc.])
The recorder will not display these file numbers on its screen. You can view them only via a connected computer.
- ② File number (The original file number used before the file was moved to the Recycle Bin)
- ③ Original folder name (The folder that originally contained the file before it was moved to the Recycle Bin)
- ④ Recording date (Year, Month, Day: Date of the file recording)
- ⑤ Recording time (Hour, Minute: Start time of the file recording)
- ⑥ Extension (File format: MP3 for an MP3 recording file, and WAV for a PCM recording file)

Transferring audio files from the recorder to a computer

■ Windows:

1. Connect the recorder to a computer.
2. Open [My Computer] from the [Start] menu.
3. Double-click the [PRW24] or [PRW24SD] folder.
4. Double-click the folder (MIC_A–MIC_D) that contains the file that you wish to load to your computer.
5. Copy the file to the desired location.

■ Macintosh:

1. Connect the recorder to a computer.
2. Double-click the drive icon [PRW24] or [PRW24SD] of the recorder on the desktop.
3. Double-click the folder (MIC_A–MIC_D) that contains the file that you wish to load to your computer.
4. Copy the file to the desired location.

Hint:

· Transferring audio files from the computer to the recorder

In Step 4 (for Windows) or Step 3 (for Macintosh), drag and drop the audio files that you wish to transfer (such as MP3 files or WMA files) into the [MUSIC] folder. The MUSIC (M) folder stores music and other audio files transferred from a connected computer.

Before transferring audio files to the MIC(A–D) folders or LINE (L) folder, rename the files following the file naming rules (see [page 70](#)). The unit will not play files that do not comply with the file naming rules, unless they are in the MUSIC (M) folder.

Copying audio files to a CD-R

You can copy audio files (that were recorded on the recorder) to a CD-R disc by using Windows Media Player.

Please visit the Microsoft website for information on how to obtain Windows Media Player.
<http://www.microsoft.com/windows/windowsmedia/>

Note:

- This section uses Windows XP and Windows Media Player 11 as examples.
- To copy audio files to a CD-R disc, you must have a CD writer, such as a CD-R/RW drive.

1. From the [Start] menu, select [All Programs], then click [Windows Media Player] to start Windows Media Player.
2. Right-click [Burn] in the menu bar, then select [Audio CD] or [Data CD].

[Audio CD]	Audio files are converted to CD-DA format and copied to a CD-R/RW disc. You can play the disc on a CD-R compatible CD player in your home or car.
[Data CD]	Audio files (MP3 or PCM) are copied to a CD-R/RW disc without conversion. You can play the disc on a computer, but not on an audio CD player.

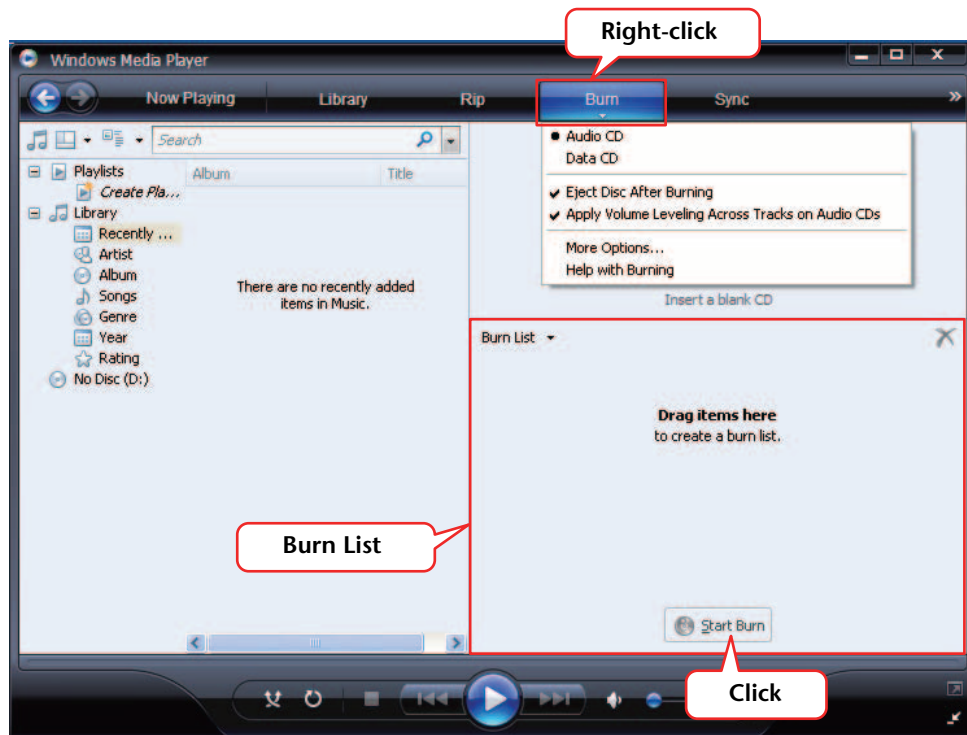

3. Insert a new CD-R/RW disc into the CD-R/RW drive.
4. Drag and drop the audio files you wish to copy to the Burn List pane in the Windows Media Player panel.
5. Click [Start Burn] to start copying the files to the CD-R/RW disc.

13 Using the Recorder as a Music Player

If you install Windows Media Player or iTunes on your computer and transfer music files to the connected recorder, you can use the unit as a music player.

Please visit the Microsoft website for information on how to obtain Windows Media Player.
<http://www.microsoft.com/windows/windowsmedia/>

Note: _____

- This section uses Windows XP and Windows Media Player 11 as examples.
- Copying commercially-available music data is strictly prohibited except for your personal use.
- Yamaha makes no representations or warranties with regard to the content of files, and cannot be held responsible for the failure of transfers or downloads, or for damage or erasure of music files due to malfunction of the unit or your computer.

Ripping CDs (Creating compatible music files from music CDs)

You can import music files from music CDs into your computer and convert them to MP3 or WMA files so that they can be played on the recorder.

1. From the [Start] menu, select [All Programs], then click [Windows Media Player] to start Windows Media Player.
2. Right-click [Rip] in the menu bar, then select [Format] → [mp3].

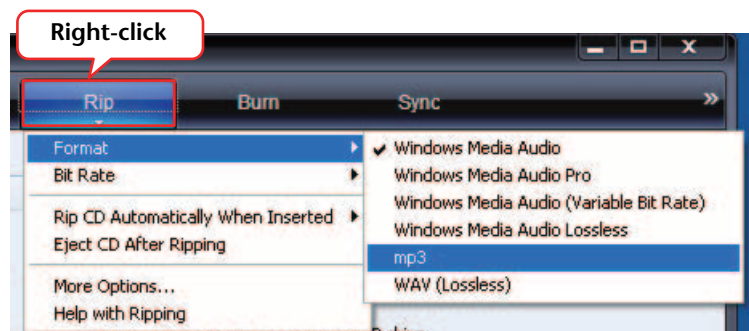

3. Click [Rip] in the menu bar.

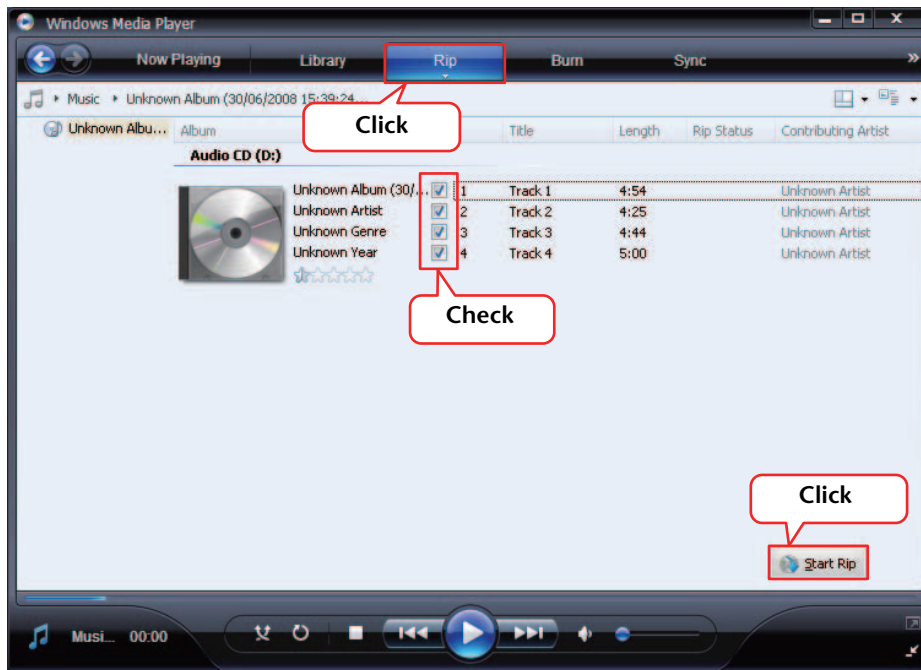

4. Insert a music CD into the computer's CD-ROM drive.

Note:

- If your computer has access to the Internet, the system will automatically obtain and display music information related to the CD.

5. Check the box for each song that you wish to rip to your computer, then click [Start Rip].

The system starts ripping the CD.

Note:

- You can also set Windows Media Player so that inserting a music CD will automatically start ripping.

Transferring music files to the Recorder (Sync function)

You can transfer audio files (ripped from a music CD to a computer) to the recorder for playback. For information on how to rip a music CD, refer to the “Ripping CDs (Creating compatible music files from music CDs)” on [page 73](#).

1. From the [Start] menu, select [All Programs], then click [Windows Media Player] to start Windows Media Player.
2. Click [Sync] in the menu bar.
3. Connect the recorder to the computer.

Note: _____

· If the system displays the “Device Setup” window, click [Finish].

4. Right-click [Sync] in the menu bar, then select [Pocketrak] or [Pocketrak SD] → [Advanced Options...].
5. Check the box for “Create folder hierarchy on device” on the [Sync] tab, then click [OK].

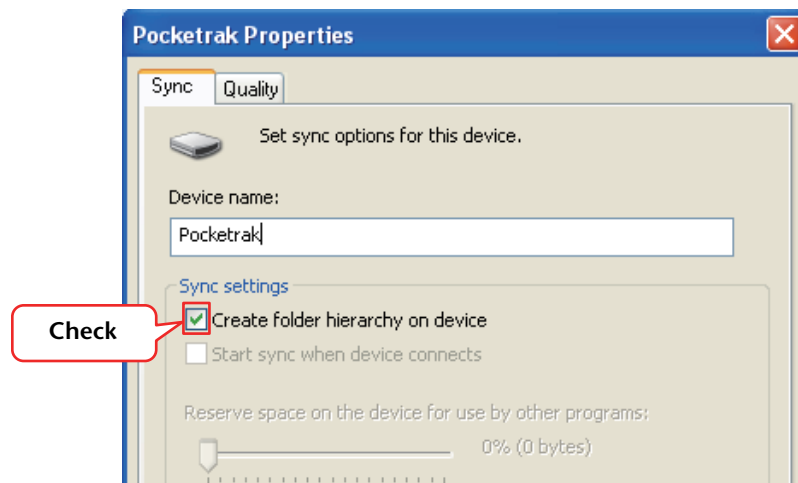

Note: _____

· If the box has already been checked by default, the folder may not be created. Remove the check from the box, then check the box again, and then click [OK].

6. Drag and drop the desired music files from the Library pane in the left column of the window to the Sync List pane in the right column of the window.

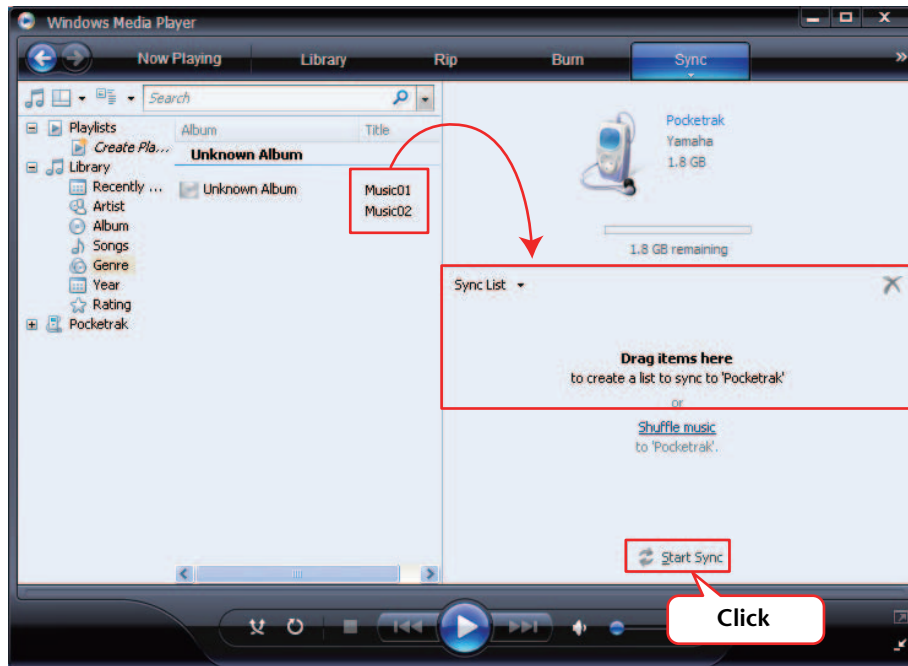

7. Click [Start Sync].
The files will be transferred to the recorder.

Playing back tracks in a specific sequence

The recorder features the Playlist function, offering five Playlist files PLIST 1–5.M3U (see [page 44](#)). You can also create a Playlist using the computer to play back tracks in the desired sequence.

 Using the Playlist function (available only for the MUSIC folder) ([page 44](#))

Creating a Playlist

You can create a Playlist to play back tracks in a desired sequence.

The recorder supports playlist files that are in M3U format with the extension “.m3u”. An M3U format file stores multimedia playlists that specify the location of media files (such as MP3 files).

1. From the [Start] menu, select [All Programs] → [Accessories], then click to open [Notepad].
2. Enter the file names included in the MUSIC (M) folder into the Playlist in the desired sequence.

Enter the file names into the Playlist in the following format: “Drive name:\Folder name\File name”. See the example below.

Note:

- To make sure that you enter each file name correctly, check the properties of the music file that you wish to include in the Playlist, copy the displayed file name, then paste the name into a Playlist you create using Notepad.

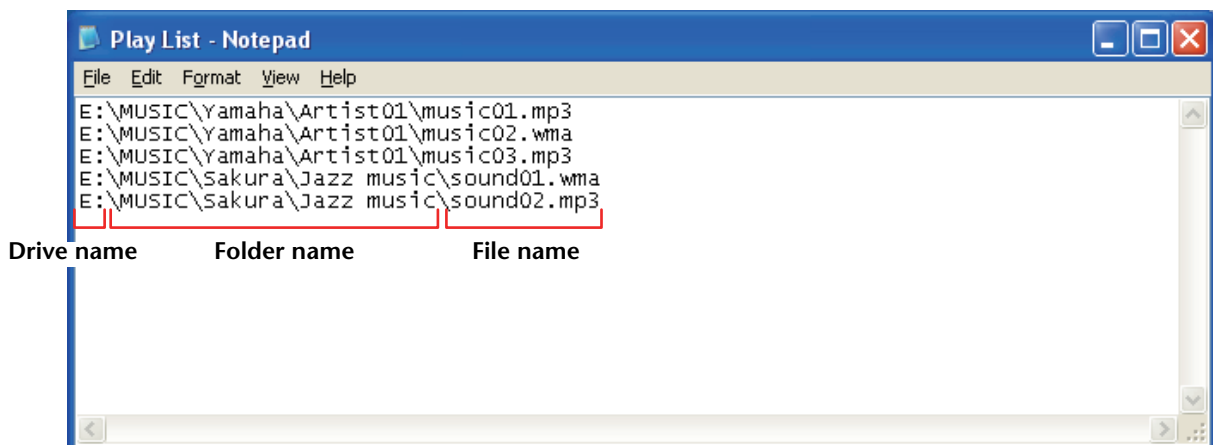

3. From the [File] menu, select [Save As...], then name the file “xxx(file name).m3u” to save the Playlist.
4. Transfer the saved Playlist file to the MUSIC (M) folder on the recorder (see [page 71](#)).

Be sure to transfer the Playlist file directly to the root level of the MUSIC (M) folder.

Note:

- You must place the Playlist file at the root level of the MUSIC (M) folder, NOT in any sub-folder inside the MUSIC folder.
- You can assign up to 99 tracks to each Playlist.

5. Disconnect the recorder from the computer (see [page 64](#)).

Hint:

- For information on how to play tracks from the Playlist, refer to [page 27](#).

14 Installing Cubase AI

The recorder ships with a DVD disc that contains the DAW software “Cubase AI.” You can use this software to edit and mix audio files. This section explains how to install Cubase AI. Refer to the PDF documentation supplied with Cubase AI (Getting Started and Operation Manual, opened from the “Help” menu).

Note:

- You can not copy audio files to a CD-R disc by using Cubase AI. To copy audio files to a CD-R disc, refer to [page 72](#).

⚠ IMPORTANT

Since the End-User Software License Agreement (EUSLA) displayed on your computer when you install the DAW software is superseded by the agreement in the included Owner’s Manual (printed version), you should disregard the EUSLA. Please read the Software License Agreement in the included Owner’s Manual carefully, and install the software if you agree to it.

1. Start the computer and log on to the Administrator account.
2. Insert the Cubase AI DVD-ROM into the DVD-ROM drive.
3. When the “WELCOME TO CUBASE AI” window appears, choose your preferred language by clicking on the corresponding national flag icon.
4. Click “Install CUBASE AI.”
5. Follow the onscreen instructions to install the software.

Note:

- In order to have continuous use of Cubase AI, including support and other benefits, you will need to register the software and activate your software license by starting it while the computer is connected to the Internet. Click the “Register Now” button shown when the software is started, then fill in all required fields for registration. If you do not register the software, you will be unable to use it after a limited period of time expires.

15 Appendix

Error messages

The following table explains the error messages that you may see during operation of the recorder.

Unit status or function	Error message	Description
Low battery	LOW BATTERY! REPLACE BATTERY	The battery is exhausted. Replace the battery with a new one.
Recording	MEMORY FULL!	The internal memory or the microSD card does not have sufficient free space for recording.
	FILE FULL!	You attempted to record more files than the maximum number of files allowed for the selected folder.
Playback	NO DATA!	You pressed the [PLAY/SPEED ▶] button but the selected folder contains no files.
	CANNOT CHANGE PLAYBACK SPEED!	You attempted to change the playback speed while playing back a PCM recording. You cannot change the playback speed of PCM (WAV) files.
Editing (Index)	INDEX FULL!	You attempted to insert more index marks than the maximum number (36) of index marks allowed per file. No more index marks will be recorded.
Editing (File division)	CANNOT DIVIDE! FOLDER FULL!	You attempted to divide a file when the corresponding folder contains the maximum number of files allowed.
	CANNOT DIVIDE! MEMORY FULL!	The internal memory or the microSD card does not have sufficient free space to divide a file.
	CANNOT DIVIDE! REC TIME TOO SHORT !	The recording is too short in duration to divide.
	CANNOT DIVIDE! AT THIS POINT	You cannot divide the file at the current point.

Unit status or function	Error message	Description
Editing (Fade in/fade out)	CANNOT FADE IN! FILE TOO SHORT!	The file is too short in duration (ten seconds or less) to apply the fade in effect.
	CANNOT FADE OUT! FILE TOO SHORT!	The file is too short in duration (ten seconds or less) to apply the fade out effect.
	CANNOT FADE IN! READ-ONLY FILE!	You attempted to apply the fade in effect to a file other than a PCM (WAV) file. You cannot apply the fade in effect to any files other than PCM (WAV) files.
	CANNOT FADE OUT! READ-ONLY FILE!	You attempted to apply the fade out effect to a file other than a PCM (WAV) file. You cannot apply the fade out effect to any files other than PCM (WAV) files.
	MEMORY FULL!	The internal memory or the microSD card does not have sufficient free space for applying the fade in or out effect.
Editing (General)	CANNOT EDIT! READ-ONLY MODE!	You attempted to edit a file in the MUSIC folder using the [EDIT MENU].
List screen	NO FILE	The selected folder does not contain any files that can be played on the unit.
Recycle Bin	CANNOT EDIT! READ-ONLY MODE!	You attempted to edit a file in the Recycle bin folder using the [EDIT MENU].
	FOLDER FULL!	You cannot move the file from the Recycle Bin to its original folder because the folder contains the maximum number of files allowed.
	RECYCLE BIN FULL!	You attempted to delete a file while the Recycle Bin function was turned on and the Recycle Bin folder contained the maximum number of files allowed (199 files).
	PLEASE EMPTY THE RECYCLE BIN FIRST!	The internal memory or microSD card does not have sufficient free space, and files or folders cannot be deleted. Empty the Recycle Bin folder.
microSD card	NO MEDIA!	You attempted to record or play back a file with no microSD card inserted. Insert a microSD card.
	SD CARD ACCESS ERROR! INSERT AGAIN!	The recorder did not recognize the inserted microSD card, or the card is broken. Try inserting the card again.
	SD CARD WRITE SPEED TOO SLOW!	PCM recording was incomplete or the data was not written correctly.

Unit status or function	Error message	Description
Playlists	NO MORE FILE FOR THIS PLAYLIST!	You attempted to assign a 100th file to one of the Playlists (PLIST).
	PLAYLIST CAN BE EDITED ONLY IN MUSIC FOLDER	You attempted to select a file in a folder other than the MUSIC (M) folder and assign it to one of the Playlist (PLIST).
	TOO MANY FILES FOR A PLAYLIST!	You attempted to assign more than 100 files to one of the Playlists (PLIST).
	NO FILE IN PLAYLIST!	The original file of the track assigned to one of the Playlist (PLIST) has been deleted.
	PLAYLIST FILE CANNOT BE SELECTED	You selected a Playlist (PLIST) while the list screen is displayed and pressed the [SCENE/PHRASE] button.

Troubleshooting

The unit does not operate.

Possible cause	Battery is not inserted properly or is exhausted.
Corrective action	Reinsert the battery correctly or replace it with a new battery (refer to the Owner's Manual).

Buttons do not work.

Possible cause	The Hold function is set.
Corrective action	Set the [HOLD] switch (located on the rear panel of the unit) to its original position to cancel the Hold function.

Possible cause The USB terminal is still connected to the computer.

Corrective action Disconnect the unit from the computer (see [page 64](#)).

The unit does not recognize the inserted microSD card.

Possible cause	The microSD card is not inserted correctly.
Corrective action	Turn off the power to the unit, then insert the microSD card correctly.

Possible cause The microSD card was formatted on a computer or device other than the recorder.

Corrective action Use the recorder to format the microSD card (see [page 53](#)).

No sound.	
Possible cause	The volume is turned down too low.
Corrective action	Use the [VOL +/-] button to adjust the volume level.

Files in the MIC (A–D), LINE or Recycle Bin () folders cannot be played.	
Possible cause	The file name is wrong.
Corrective action	If you change the file name on a computer, then move the file back to the MIC (A–D) folder, you cannot play the file on the unit. Transfer the file to the MUSIC (M) folder to play it.

Possible cause	The audio file is not in the type of WAV format that is supported by the unit.
Corrective action	The unit will not play back a WAV file that was not recorded on the unit.

Files in the MUSIC (M) folder cannot be played (correctly or at all).	
Possible cause	The file is not in a playable format.
Corrective action	Use MP3 or WMA files.

Possible cause	The audio file is not in the type of PCM (WAV) format that is supported by the unit.
Corrective action	The unit will not play back a WAV file that was not recorded on the unit.

Possible cause	The file was transferred to an incorrect destination.
Corrective action	The unit will not play files that were transferred from a computer to a folder other than the MUSIC (M) folder. Be sure to transfer the file to the MUSIC (M) folder in the [PRW24] or [PRW24SD].

Possible cause	The file is not compatible with the unit.
Corrective action	Create a file using different MP3/WMA encoder software.

Possible cause	The files listed in the Playlist are missing from the MUSIC (M) folder.
Corrective action	Delete the file names from the Playlist. Alternatively, transfer the missing files to the MUSIC (M) folder.

Possible cause	The maximum number of playable files has been exceeded.
Corrective action	The unit can play back up to 199 files per folder. If the folder contains sub-folders, the maximum number of playable files will be reduced by the number of sub-folders. Store extra files in another folder.

A file cannot be divided.	
Possible cause	The internal memory or the microSD card may have insufficient free space.
Corrective action	Erase unnecessary files (see page 51).
Possible cause	The file is too short to divide.
Corrective action	The minimum file length required for the file division operation varies with the recording mode (see page 41).

A file cannot be erased.	
Possible cause	The attribute of the file is set to "read only."
Corrective action	Connect the unit to a computer and change the file attribute or erase the file using the computer. Alternatively, format the microSD card (see page 53).

[PRW24] or [PRW24SD] icon does not appear when you connect the unit to the computer.	
Possible cause	The unit is not connected to the computer correctly.
Corrective action	Make sure that the USB cable is securely and correctly connected to the unit and to the computer (see page 63).
Possible cause	Power supplied from the computer to the unit is insufficient.
Corrective action	If the recorder is connected via a bus-powered USB hub, remove the hub, then use the included USB cable to connect the recorder directly to the computer's USB terminal. Alternatively, use a self-powered USB hub (with the power adaptor). If the computer features multiple USB terminals, use a different USB terminal to connect the recorder (see page 63).
Possible cause	A network drive has been assigned.
Corrective action	If a network drive has been assigned, the drive letter (an alphabet letter used as the drive name) is already taken. In this case, [PRW24] or [PRW24SD] icon may not be created. Change the network drive assignment, then reconnect the unit. Consult your network administrator regarding how to reassign the network drive.
Possible cause	The connected computer does not recognize the recorder.
Corrective action	If the computer does not recognize the unit, try connecting it again. If you connect the unit to any computer other than those supported by the unit, Yamaha will not guarantee the operation of the unit (see page 63).

The file transfer speed (from the computer to the unit) is slow.	
Possible cause	The unit is connected to a USB1.1 terminal on the computer.
Corrective action	Connect the unit to a USB2.0 High Speed terminal.

When the unit is connected to the computer, the unit does not display the “Connected” icon.	
Possible cause	The unit is not connected to the computer correctly.
Corrective action	In some cases, the unit may not display the “Connected” icon or may not be recognized when it is connected to a computer. Disconnect the unit from the computer, then reconnect it.

The recorded audio sounds noisy.	
Possible cause	Wind noise has been recorded.
Corrective action	<p>The built-in stereo microphone is highly sensitive. Therefore, a slight breeze or breath — even a weak air conditioning breeze that hits the microphones directly — will be recorded as noise. To reduce the level of wind and other environmental noise:</p> <ul style="list-style-type: none"> • Use the recorder with the wind screen (protection against wind and sibilance) attached to the built-in stereo microphones. • Turn on the High Pass Filter via menu item [HPF] (see page 21). • Set the [MIC SENS] (microphone sensitivity) switch to [LOW].

The recorded sound is distorted.	
Possible cause	The microphone sensitivity level may not be appropriately set.
Corrective action	<ul style="list-style-type: none"> • Set the [MIC SENS] (microphone sensitivity) switch to [LOW]. If you still hear distortion, set the High Pass Filter to ON and attach the windscreens to the recorder (see page 21). • If the ALC function is turned off, set the recording peak limiter to ON (see page 21).

The recorded sound skips.	
Possible cause	<ul style="list-style-type: none"> • The microSD card was formatted not on the recorder, but on a computer or other device. • The microSD card may be fragmented significantly.
Corrective action	Use the recorder to format the microSD card (see page 53).

Possible cause	You are using a microSD card that is not recommended by Yamaha.
Corrective action	Use a microSD card that is recommended by Yamaha (refer to the Owner’s Manual).

The date and time are displayed incorrectly.	
Corrective action	Set the correct date and time (see page 58).

Deleting files does not increase the amount of free space.	
Possible cause	The Recycle Bin function is turned on.
Corrective action	Empty the Recycle Bin (see page 50).

The timer does not work properly. (The timer recording failed.)	
Possible cause	The calendar was initialized.
Corrective action	Set the calendar (date and time) (see page 58).

Possible cause	The folder to which to record is full.
Corrective action	<ul style="list-style-type: none"> • Delete unnecessary files (see page 51). • Select a different folder to which to record.

Possible cause	The battery is exhausted.
Corrective action	Replace the battery (refer to the Owner's Manual).

Possible cause	The internal memory or microSD card may not have sufficient free space.
Corrective action	Delete unnecessary files (see page 51).

Possible cause	The microSD card has been selected as the recording destination, but the card has not been inserted in the recorder.
Corrective action	Insert a microSD card in the recorder.

The recorder does not respond to remote control operation.	
Possible cause	You attempted to operate the remote control from beyond its effective range.
Corrective action	For more information about the effective range of the remote control, refer to the Owner's Manual.

Possible cause	Direct sunlight or electric light is striking the remote sensor on the recorder.
Corrective action	Change the position of the lighting fixture or the recorder.

Possible cause	The battery is exhausted.
Corrective action	Replace the battery.

Possible cause	An object is positioned between the remote control and the remote sensor on the recorder.
Corrective action	Remove the object.

FAQ

Q: Why do I hear a rustling noise in the recordings?

A: A rustling noise may be recorded if you move the unit during recording, or even if you move your fingers while holding the unit when recording. If possible, try not to move the unit during recording.

Q: How can I transfer the recordings onto tapes or MDs?

A: Use a standard audio cable (with 3.5mm mini plugs) to connect the unit to your tape recorder or MD recorder, then dub the recordings to a tape or MD.

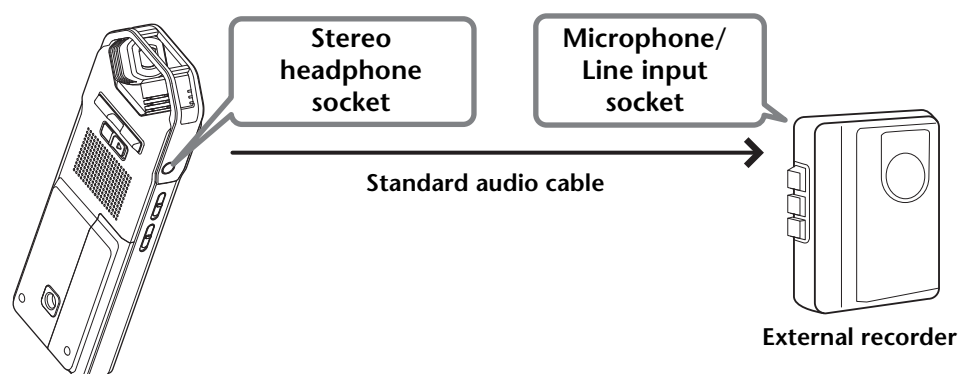

Compatible audio cable

Socket on the external recorder	Audio cable
Microphone input	3.5-mm mini plug, with resistance
Line input	3.5-mm mini plug, without resistance

- * Use a stereo audio cable.
- * Before dubbing the recordings, adjust the dubbing level on the unit.
- * You can also dub the recordings from your tape player or MD player to the unit (see [page 10](#)).

Q: Are there any tips to making a good recording?

A: Try a test recording to set the optimum recording mode and sensitivity, since the recording condition varies with the location and circumstances.

Q: I cannot play a recorded file that was stored on the computer and transferred back to the unit.

A: You may have changed the file name on the computer. If you change the file name, the file will not play, even if it is transferred back into the MIC(A-D) or LINE folder. However, you will be able to play the file if you transfer it into the MUSIC folder.

Specifications

Supported OS	Windows 7, Vista, XP Professional/Home Edition			
	Mac OS X 10.4, 10.5, 10.6			
Supported media	microSD/SDHC card			
Recording mode and estimated available recording time (with the internal 2GB memory)	PCM	24bit	96kHz	Approx. 55min.
			88.2kHz	Approx. 1hr.
			48kHz	Approx. 1hr.50min.
			44.1kHz	Approx. 2hr.
	PCM	16bit	96kHz	Approx. 1hr.25min.
			88.2kHz	Approx. 1hr.30min.
			48kHz	Approx. 2hr.50min.
			44.1kHz	Approx. 3hr.
	MP3	320kbps		Approx. 13hr.30min.
		192kbps		Approx. 22hr.30min.
		128kbps		Approx. 34hr.
		64kbps		Approx. 68hr.
		32kbps		Approx. 136hr.
Recording format	MP3, PCM (WAV)			
Playback format	MP3 (MPEG1 LAYER3, MPEG2 LAYER3), WMA			
	PCM (Only files recorded on this unit are supported.)			
Frequency response (recording with an external microphone)	PCM	96kHz/24, 16bit		40Hz–47kHz
		88.2kHz/24, 16bit		40Hz–43kHz
		48kHz/24, 16bit		40Hz–23kHz
		44.1kHz/24, 16bit		40Hz–21.7kHz
	MP3	320kbps		40Hz–21kHz
		192kbps		40Hz–20kHz
		128kbps		40Hz–17kHz
		64kbps		40Hz–7.6kHz
		32kbps		40Hz–6.7kHz
	Frequency response (recording with the built-in microphone)	60–20,000Hz (PCM recording) * The high end frequency response varies with the recording mode that was selected for recording with an external microphone. The low end response is 60Hz in all MP3 recording modes.		
Frequency response (playback)	20–23,000Hz			
Sampling frequency	16kHz–96kHz			
Bit rate (playback)	16–320kbps (MP3)			
	32–192kbps (WMA) * Some files may not be played back correctly.			
Connectors	USB mini, Stereo headphones 3.5-mm mini, Stereo microphone (line input) 3.5-mm mini, microSD card slot			

Operating temperature	+5°C – +35°C (+41°F – +95°F)
Output (headphones)	10mW + 10mW (at 16Ω load)
Power supply	“AA/LR6” alkaline battery (1) or “AA” nickel-metal hydride battery (1)
Battery life for recording	Alkaline battery: MP3 64kbps Approx. 56 hours, PCM 44.1kHz 16bit Approx. 38 hours (Recording condition: Recording LED off, backlight off, no recording monitoring, ALC on)
Battery life for playback through headphones	Alkaline battery: MP3 64kbps Approx. 70 hours, PCM 44.1kHz 16bit Approx. 45 hours (Playback condition: Playback LED off, backlight off, FLAT sound EQ)
Battery life for playback through the speaker	Alkaline battery: MP3 64kbps Approx. 43 hours, PCM 44.1kHz 16bit Approx. 36 hours (Playback condition: Playback LED off, backlight off, FLAT sound EQ)
Dimensions	Approx. 46.5 (W) x 129.5 (H) x 17.5 (D) mm 1-13/16 (W) x 5-1/8 (H) x 11/16 (D) inch
Weight	Approx. 92 g (3.2 oz) (including an alkaline battery)
Included accessories	AA/LR6 alkaline battery (1) Wireless remote control (1) Lithium battery(CR2025) (1) Microphone stand adapter (1) Windscreen (1) DVD-ROM (1) USB cable (1) Owner’s Manual (1)

- Battery life varies depending on the type and manufacturer of the battery, storage conditions, usage, ambient temperature, etc. The battery life values listed above are estimates and are not guaranteed.
- The battery life of a nickel-metal hydride battery is about 70% of that of an alkaline battery. Also, the voltage of a nickel-metal hydride battery is different from that of an alkaline battery. Therefore, the remaining battery power for a nickel-metal hydride battery may not be displayed correctly. You cannot charge a nickel-metal hydride battery using the unit.
- The available recording time refers to the optimal total recording time available for all folders, and assumes that no recorded data exists in the internal memory and that one continuous recording is made without changing the recording mode.
- The largest available recording space (for continuous recording) in one file is 2GB. If the largest available recording space (2GB) is reached, recording in the next file will automatically start in about two seconds (when using a microSDHC card). However, you will be unable to record continuously beyond the battery life.
- When you purchase the recorder, the manuals are stored in PDF format in the internal memory. Therefore, the actual available recording time is less than the above time.
- Specifications and descriptions in this owner’s manual are for information purposes only. Yamaha Corp. reserves the right to change or modify products or specifications at any time without prior notice. Since specifications, equipment or options may not be the same in every locale, please check with your Yamaha dealer.

Index

Symbols

- ▶▶ button 4
- ◀◀ button 4

A

- A-B Repeat playback 31
- Alarm..... 54
- ALC (Auto Level Control) 17
- ALC ON/OFF switch..... 6
- Audio cable..... 10, 86
- Audio files..... 71
- Auto Divide..... 23
- Auto Power Off..... 60
- Available recording time 87

B

- Backlight..... 61
- Battery cover..... 6
- Beat 39
- Beep sound..... 59
- Bit rate..... 8
- Built-in stereo microphone..... 5

C

- Calibrating..... 37
- CD..... 72, 73
- CD player 10
- Computer 63
- Contrast..... 61
- Cubase AI 78

D

- Date 58
- DELETE button..... 6
- Deleting
 - Deleting a selected file..... 51
 - Deleting all data 53
 - Deleting all files from a folder..... 52
- Dividing files 40

E

- EDIT MENU 40
- Editing Files 40
- EQ (equalizer)..... 18, 34
- Error messages..... 79
- External audio device..... 10
- External microphone..... 9

F

- Fade in 42
- Fade out 42
- FAQ..... 86
- Fast forwarding..... 28
- Fast reversing..... 28
- File..... 65
- File names 41, 70
- Folder 65
- Folder structure 69
- FOLDER/A-B REPEAT button..... 5
- Formatting the internal memory/
a microSD card 53
- Frequency..... 18, 34

H

- Headphones 28
- Headphones socket..... 6
- High Pass Filter (HPF)..... 21
- HOLD switch 6

I

- Index marks 43
- Indicators displayed during playback 27
- Initializing 62
 - Formatting the internal memory/
a microSD card..... 53
 - Initializing the menu settings..... 62
- Input (recording level) 13

L

- LCD screen 4, 8
- LED..... 5, 25, 60
- Level meter..... 8, 27
- Linear PCM..... 8
- LIST/INDEX button 5
- Locating the file to play back 28
- Locating the index 28

M

Manual	3
MD	86
MENU RESET	62
MENU/ENTER button.....	4
Metronome	38
MIC SENS HIGH/LOW switch.....	6, 17
MIC/LINE  socket	5
Microphone.....	9
Microphone sensitivity.....	17
Microphone stand (adapter).....	6
microSD card.....	6, 53
MP3.....	8, 16
Music.....	73

P

PCM (WAV)	8, 16
Pitch	37
PLAY/SPEED  button	5
Playback	26
Playing back files	26
Playing back tracks from the Playlist	27
Repeat playback	32
Using the A-B Repeat playback function.....	31
Using the Phrase playback function	31
Using the Skip playback function.....	30
Playback speed	29
Playlist	44, 77
POWER button.....	5
Preference settings.....	58
Preset	
Recording EQ	18
Recording scene	12

R

REC/PAUSE  button	4
Recording	
Recording from an external audio device (such as a CD player).....	10
Recording EQ (equalizer)	18
Recording mode	16
Recording peak limiter	21
Recording scene.....	12
Recycle Bin	47
Remote control	7, 59
Repeat playback.....	31, 32
Ripping CDs.....	73

S

SCENE/PHRASE button	5
Self timer	24
Skip playback.....	30
Sound EQ (equalizer).....	34
Sound quality	16
Speaker.....	6
Specifications.....	87
Speed	
Changing the playback speed	29
Setting the metronome tempo (speed).....	38
STANDBY mode.....	13
Stereo mini plug	10
STOP/ESC  button	4
Storing	65, 69
Sync	75

T

Tempo.....	38
Threaded socket for attaching a tripod	6
Time	58
TIME SEARCH	33
Timer.....	54
Transferring files	71
tripod	6
Troubleshooting	64, 81
Tuner.....	37

U

USB terminal.....	6
USER.....	20, 36

V

VAS (Voice Activated System).....	22
Version	62
Voice sensing level (VAS value)	22
VOL + / - button	4
Volume.....	4

W

Windows Media Player.....	72
---------------------------	----